

# 5MP LightHunter Active Deterrence Mini PTZ Camera IPC6315LFW-AX5C-VG1



## Features

- High quality image with 5 MP, 1/2.8" CMOS sensor
- Ultra 265, H.265, H.264, MJPEG
- Smart intrusion prevention, supports false alarm filtering, including cross line, intrusion, enter area, leave area detection
- LightHunter technology ensures ultra-high image quality in low illumination environment
- Up to 120 dB WDR (wide dynamic range)
- Built-in mic and speaker
- Smart IR, up to 50 m (164.0 ft.) IR distance and 15 m (49.2 ft.) warm light distance
- MicroSD, up to 512 GB
- IP66 protection
- DC 12 V, PoE (IEEE 802.3at) power supply

## Specifications

Model	IPC6315LFW-AX5C-VG1
<b>Camera</b>	
Max Resolution	5 MP
Sensor	1/2.7" CMOS
Min. Illumination	Color: 0.005 Lux (F1.6, AGC ON), 0 Lux with IR
Day/Night	IR-cut filter with auto switch (ICR)
Shutter	Auto/Manual, 1 to 1/100000 s
WDR	120 dB
S/N	>56 dB
<b>Lens</b>	
Focal Length	2.7 to 13.5 mm
Iris	F1.6
Optical Zoom	5X
Field of View (H)	106.91° to 33.55°
Field of View (V)	56.45° to 18.99°
Field of View (D)	123.1° to 42.1°
<b>DORI</b>	
DORI Distance (Detect)	72.0 m to 229.5 m (236.2 ft. to 753.0 ft.)
DORI Distance (Observe)	28.8 m to 91.8 m (94.5 ft. to 301.2 ft.)
DORI Distance (Recognize)	14.4 m to 45.9 m (47.2 ft. to 150.6 ft.)
DORI Distance (Identify)	7.2 m to 23.0 m (23.6 ft. to 75.5 ft.)
<b>Video</b>	
Privacy Mask	Up to 4 areas
Video Compression	Ultra 265, H.265, H.264, MJPEG
Frame Rate	Main Stream: 5 MP (2880 × 1620), max. 30 fps Sub Stream: 720P (1280 × 720), max. 30 fps
Video Bit Rate	128 Kbps to 16 Mbps
U-code	Support
ROI	Support
Video Stream	Dual streams
OSD	Up to 4 OSDs
<b>Image</b>	
White Balance	Auto, Outdoor, Fine tune, Sodium lamp, Locked, Auto2
Digital Noise Reduction	2D/3D DNR
Smart IR	Support
Flip	Normal, Flip vertical, Flip horizontal, 180°
HLC	Support
BLC	Support
Defog	Digital defog
<b>Illuminator</b>	
Light On/Off Control	Auto/Manual





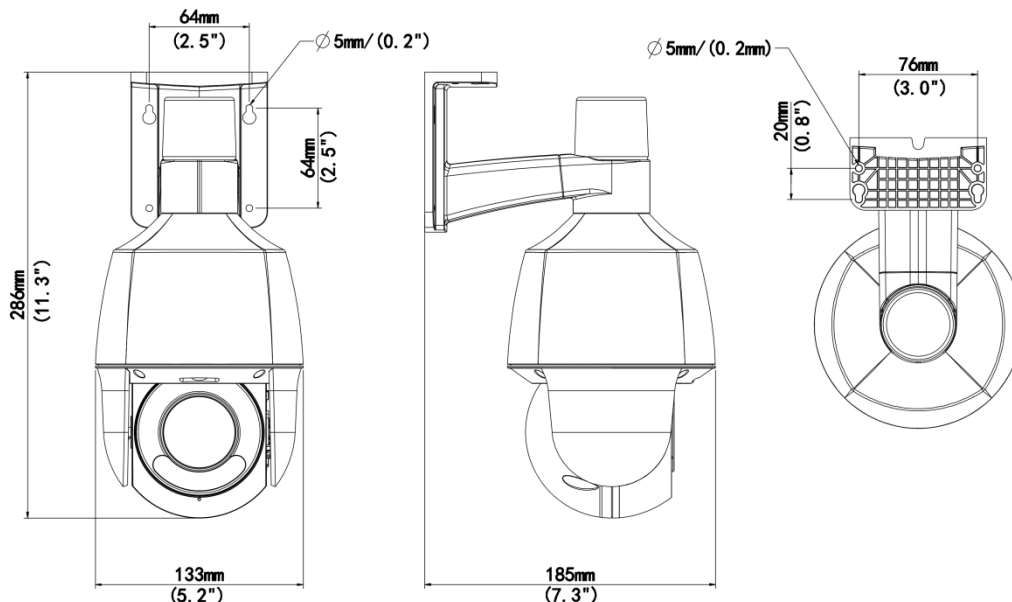

Wavelength	850 nm
Illumination Distance (IR)	50 m (164.0 ft.)
Illumination Distance (Warm Light)	15 m (49.2 ft.)
<b>Intelligent</b>	
Auto Tracking	Support, target filtering: human only
Smart Intrusion Prevention	Cross line detection, intrusion detection (support false alarm filtering and the classification of human and vehicle)
<b>Events</b>	
Basic Detection	Motion detection, Tampering alarm, Audio detection
General Function	Watermark, IP address filtering, Access policy, ARP protection, RTSP authentication, User authentication
<b>Audio</b>	
Audio Compression	G.711U, G.711A
Audio Bitrate	128 Kbps
Two-way Audio	Support
Suppression	Support
Sampling Rate	16KHZ
<b>Storage</b>	
Edge Storage	MicroSD, up to 512 GB
Network Storage	ANR, NAS (NFS)
<b>Network</b>	
Protocols	TLS1.3, SSH, IGMP, RTP, RTCP, SMTP, IPv4, IPv6, ICMP, ARP, TCP, UDP, DHCP, PPPoE, RTSP, RTMP, DNS, DDNS, NTP, FTP, UPnP, HTTP, HTTPS, 802.1x, SNMP, QoS, SSL/TLS
Compatible Integration	ONVIF (Profile S, Profile G, Profile T, Profile M), SDK, API
Security	Password Protection, Strong Password, HTTPS Encryption, Export Operation Logs, Basic and Digest Authentication for RTSP, Digest Authentication for HTTP, TLS 1.2, WSSE and Digest Authentication for ONVIF
Client	EZStation, UNV-Link, UNV-Link Pro
Web Browser	Plug-in required live view: IE 10 and above, Chrome 45 and above, Firefox 52 and above, Edge 79 and above
<b>PTZ</b>	
Number of Presets	1024
Preset Patrol	16 patrols, up to 64 presets for each patrol
Patrol Stay Time	120 s to 1800 s
Home Position	Support
Pan Range	0° to 345°
Tilt Range	-10° to 100°
Pan Speed	1°/s to 40°/s
Tilt Speed	1°/s to 30°/s
<b>Interface</b>	
Audio I/O	1 Input: impedance 1 kΩ, amplitude 2.5 V [p-p], 1 Output: impedance 600 Ω, amplitude 2.5 V [p-p]
Alarm I/O	1/1

Built-in Mic	Support
Built-in Speaker	Support
Network	1 × RJ45 10 M/100 M Base-TX Ethernet
<b>Certification</b>	
EMC	CE-EMC (EN 55032: 2015+A11: 2020+A1: 2020, EN 50130-4: 2011+A1: 2014, EN 61000-3-3: 2013+A1: 2019+A2: 2021, EN IEC 61000-3-2: 2019+A1: 2021)
Safety	CE LVD (EN 62368-1: 2020+A11: 2020) UL (UL 62368-1, 2nd Ed., Issue Date: 2014-12-01)
Environment	CE-ROHS (2011/65/EU;(EU)2015/863)
Protection	IP66 (IEC 60529:1989+AMD1:1999+AMD2:2013)
<b>General</b>	
Power	DC 12 V (±25%), PoE (IEEE 802.3at)
Power Consumption	18 W
Power Interface	Ø5.5 mm coaxial power plug
Dimensions	133 mm × 185 mm × 286 mm (Ø 5.2" × 7.3" × 11.3" ) (L × W × H)
Weight	788 g (1.74 lb.)
Working Environment	-30 °C to 60 °C (-22 °F to 140 °F), Humidity: ≤ 95% RH (non-condensing)
Storage Environment	-40 °C to 70 °C (-40 °F to 158 °F), Humidity: ≤ 95% RH (non-condensing)
Surge Protection	2 KV
Reset Button	Support
Heater	Support
Web Client Language	22 Languages: Traditional Chinese, English, Simplified Chinese, Polish, German, Russian, French, Korean, Dutch, Czech, Portuguese (Europe), Portuguese (Brazil), Japanese, Thai, Turkish, Spanish (Latin America), Spanish (Europe), Hungarian, Italian, Vietnamese, Arabic, Slovak
<b>Configurable</b>	
P/N	Support

## Dimensions



## Accessories

<p><b>TR-JB07-D-IN</b> Bullet Junction Box(Support wiring from behind)</p>	<p><b>TR-CM06-D</b> Alarm Ball Machine Hoisting Bracket</p>	<p><b>TR-UC08-C</b> Bullet&amp;Dome Corner Mounting Bracket</p>
		
<p><b>TR-A01-IN</b> NPT 3/4" Waterproof Cable Gland</p>	<p><b>TR-UP06-C-IN</b> Pole Mounting Bracket for Bullet Junction Box Only</p>	<p><b>TR-UP06-B-IN</b> Bullet Pole Mounting Bracket</p>
		

# Unlimited New View

## Zhejiang Uniview Technologies Co., Ltd.

 <http://www.uniview.com>

 [overseasbusiness@uniview.com](mailto:overseasbusiness@uniview.com); [globalsupport@uniview.com](mailto:globalsupport@uniview.com)

 No. 369, Xietong Road, Xixing Sub-district, Binjiang District, Hangzhou City, 310051, Zhejiang Province, China



©2023-2025 Zhejiang Uniview Technologies Co., Ltd. All rights reserved.

\*Product specifications and availability are subject to change without notice.

Despite our best efforts, technical or typographical errors may exist in this document. Uniview cannot be held responsible for any such errors and reserves the right to change the contents of this document without prior notice.