

# 8MP HD Intelligent ColorHunter Fixed Eyeball Network Camera IPC3618SE-ADF28(40)KM-WL-I0



## Features

- High quality image with 8 MP, 1/2.8" CMOS sensor
- 8 MP (3840 × 2160)@20 fps; 5 MP (3072 × 1728)@30/25 fps; 4 MP (2560 × 1440)@30/25 fps; 1080P (1920 × 1080)@30/25 fps
- Ultra 265, H.265, H.264, MJPEG
- Smart intrusion prevention, supports false alarm filtering, including cross line, intrusion, enter area, leave area detection
- Based on target classification, smart intrusion prevention significantly reduces false alarm caused by leaves, birds and lights, accurately focusing on human, motor vehicle and non-motor vehicle
- automatic selection of best snapshots, supports face detection masked area
- People counting, supports people flow counting and crowd density monitoring, suitable for different statistical scenarios
- 120 dB true WDR technology enables clear image in strong light scene
- Supports 9:16 corridor mode
- Built-in mic
- Smart illuminator, up to 30 m (98.4 ft) white light range
- MicroSD, up to 512 GB
- IP67 protection

## Specifications

| Model                              | IPC3618SE-ADF28KM-WL-I0   | IPC3618SE-ADF40KM-WL-I0 |
|------------------------------------|---|-------------------------|
| <b>Camera</b>                      |   |                         |
| Max Resolution                     | 8 MP  |                         |
| Sensor                             | 1/2.8" CMOS   |                         |
| Min. Illumination                  | Color: 0.0005 Lux (F1.0, AGC ON)  |                         |
| Shutter                            | Auto/Manual, 1 to 1/100000 s  |                         |
| Adjustment Angle                   | Pan: 3° to 360°, Tilt: 0° to 80°, Rotate: 3° to 360°  |                         |
| S/N                                | >56 dB  |                         |
| WDR                                | 120 dB  |                         |
| <b>Lens</b>                        |   |                         |
| Focal Length                       | 2.8 mm  | 4.0 mm                  |
| Iris Type                          | Fixed   |                         |
| Iris                               | F1.0  |                         |
| Field of View (H)                  | 106.7°  | 87.5°                   |
| Field of View (V)                  | 57.1°   | 46.3°                   |
| Field of View (D)                  | 115.7°  | 92.4°                   |
| Lens Type                          | Fixed   |                         |
| <b>DORI</b>                        |   |                         |
| DORI Distance (Lens)               | 2.8 mm  | 4 mm                    |
| DORI Distance (Detect)             | 86.9 m (285.1 ft.)  | 124.1 m (407.2 ft.)     |
| DORI Distance (Observe)            | 34.8 m (114.2 ft.)  | 49.7 m (163.1 ft.)      |
| DORI Distance (Recognize)          | 17.4 m (57.1 ft.)   | 24.8 m (81.4 ft.)       |
| DORI Distance (Identify)           | 8.7 m (28.5 ft.)  | 12.4 m (40.7 ft.)       |
| <b>Illuminator</b>                 |   |                         |
| Supplemental Light                 | Warm light  |                         |
| Illumination Distance (Warm Light) | 30 m (98.4 ft.)   |                         |
| Light On/Off Control               | Auto/Manual   |                         |
| <b>Video</b>                       |   |                         |
| Video Compression                  | Ultra 265, H.265, H.264, MJPEG  |                         |
| Frame Rate-Third Stream            | D1 (720 × 576), max. 30 fps; 640 × 360, max. 30 fps; 2CIF (704 × 288), max. 30 fps; CIF (352 × 288), max. 30 fps                    |                         |
| H.264 Code Profile                 | Baseline profile, Main profile, High profile  |                         |
| Video Bit Rate                     | 128 Kbps to 16 Mbps   |                         |
| U-code                             | Support   |                         |
| OSD                                | Up to 8 OSDs  |                         |
| Privacy Mask                       | Up to 4 areas   |                         |
| ROI                                | Support   |                         |
| Video Stream                       | Triple streams  |                         |
| Frame Rate-Main Stream             | 8 MP (3840 × 2160), max. 20 fps; 5 MP (3072 × 1728), max. 30 fps; 4 MP (2560 × 1440), max. 30 fps; 1080P (1920 × 1080), max. 30 fps |                         |

|                            |  |
|----------------------------|--|
| Frame Rate-Sub Stream      | 1080P (1920 × 1080), max. 30 fps; 720P (1280 × 720), max. 30 fps; D1 (720 × 576), max. 30 fps; 640 × 360, max. 30 fps; 2CIF (704 × 288), max. 30 fps; CIF (352 × 288), max. 30 fps                         |
| <b>Image</b>               |  |
| Smart Illumination         | Support  |
| White Balance              | Auto, Outdoor, Fine Tune, Sodium Lamp, Locked, Auto2   |
| Digital Noise Reduction    | 2D/3D DNR  |
| Flip                       | Normal, Flip Vertical, Flip Horizontal, 180°, 90°Clockwise, 90°Anti-clockwise  |
| Dewarping                  | Support  |
| HLC                        | Support  |
| BLC                        | Support  |
| Defog                      | Digital defog  |
| <b>Intelligent</b>         |  |
| Smart Intrusion Prevention | Cross line detection, intrusion detection, enter area detection, leave area detection (support false alarm filtering and the classification of human, non-motor vehicle and vehicle)                       |
| Statistical Analysis       | N/A  |
| People Counting            | Support people flow counting and crowd density detection   |
| <b>Events</b>              |  |
| Basic Detection            | Motion detection, Ultra motion detection, Tampering alarm, Audio detection   |
| General Function           | Watermark, IP address filtering, Access policy, ARP protection, RTSP authentication, User authentication, HTTP authentication  |
| <b>Audio</b>               |  |
| Audio Compression          | G.711U, G.711A, AAC-LC   |
| Audio Bitrate              | G.711U/G.711A: 64 kbps, AAC-LC: 128 kbps   |
| Two-way Audio              | N/A  |
| Suppression                | Support  |
| Sampling Rate              | G.711U/G.711A: 8 kHz, AAC-LC: 8 kHz, 16 kHz, 48 kHz  |
| <b>Storage</b>             |  |
| Edge Storage               | MicroSD, up to 512 GB  |
| Network Storage            | ANR, NAS (NFS)   |
| <b>Network</b>             |  |
| Protocols                  | IPv4, IPv6, IGMP, ICMP, ARP, TCP, UDP, DHCP, PPPoE, RTP, RTSP, RTCP, RTMP, DNS, DDNS, NTP, FTP, UPnP, HTTP, HTTPS, SMTP, 802.1x, SNMP, QoS, SSL/TLS, SSH   |
| Compatible Integration     | ONVIF (Profile S, Profile G, Profile T, Profile M), API, SDK   |
| User/Host                  | Up to 32 users, 2 user levels: administrator and common user   |
| Security                   | Password Protection, Strong Password, HTTPS Encryption, Export Operation Logs, Basic and Digest Authentication for RTSP, Digest Authentication for HTTP, TLS 1.2, WSSE and Digest Authentication for ONVIF |
| Client                     | EZStation, APP   |
| Web Browser                | Plug-in required live view: IE 10+, Chrome 45+, Firefox 52+, Edge 79+, Plug-in free live view: Chrome 57+, Firefox 58+, Edge 16+   |
| <b>Interface</b>           |  |
| Audio I/O                  | N/A  |
| Alarm I/O                  | N/A  |





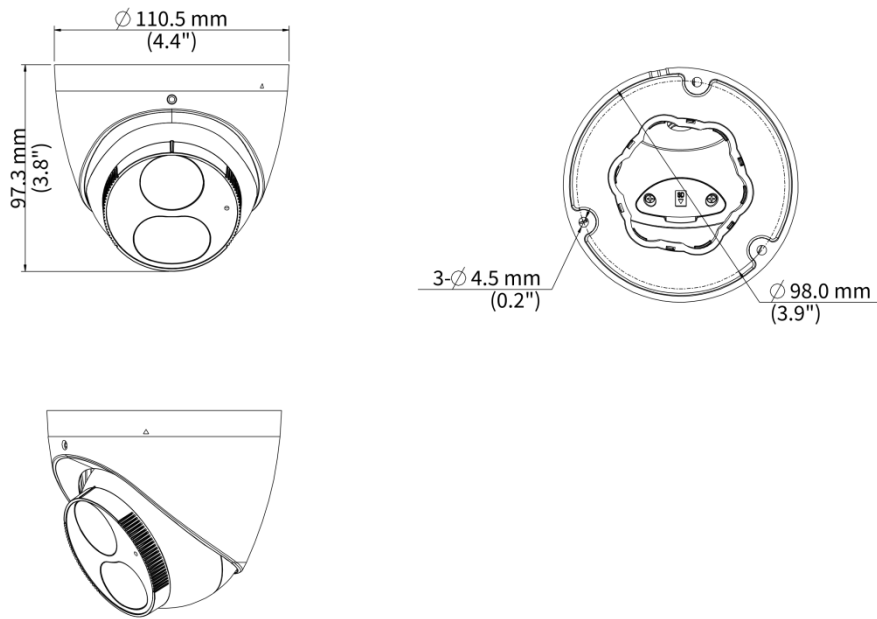

|                      |   |
|----------------------|---|
| Serial Port          | N/A   |
| Built-in Mic         | Support   |
| Built-in Speaker     | N/A   |
| WIFI                 | N/A   |
| Network              | 1 × RJ45 10 M/100 M Base-TX Ethernet  |
| Video Output         | N/A   |
| <b>Certification</b> |   |
| EMC                  | CE-EMC (EN 55032: 2015+A1:2020,EN 61000-3-3: 2013+A1: 2019,EN IEC 61000-3-2: 2019+A1: 2021,EN 55035: 2017+A11:2020)<br>FCC (FCC CFR 47 part15 B, ANSI C63.4-2014)   |
| Safety               | CE LVD (EN 62368-1:2014+A11:2017)<br>CB (IEC 62368-1:2014)<br>UL (UL 62368-1, 2nd Ed., Issue Date: 2014-12-01)  |
| Environment          | CE-RoHS (2011/65/EU;(EU)2015/863); WEEE (2012/19/EU); Reach (Regulation (EC) No 1907/2006)  |
| Protection           | IP67 (IEC 60529:1989+AMD1:1999+AMD2:2013)   |
| <b>General</b>       |   |
| Power                | DC 12 V±25%, PoE (IEEE 802.3af)   |
| Power Consumption    | Max. 8.0 W  |
| Power Interface      | Ø5.5 mm coaxial power plug  |
| Dimensions           | Ø111 mm × 95 mm (Ø4.4" × 3.7") (Ø × H)  |
| Weight               | 0.44 kg (0.97 lb.)  |
| Material             | Metal   |
| Working Environment  | -30 °C to 60 °C (-22 °F to 140 °F), Humidity: ≤ 95% RH (non-condensing)   |
| Storage Environment  | -30 °C to 60 °C (-22 °F to 140 °F), Humidity: ≤ 95% RH (non-condensing)   |
| Surge Protection     | 4 KV  |
| Reset Button         | N/A   |
| Web Client Language  | 20 Languages: Traditional Chinese, English, Simplified Chinese, Polish, German, Russian, French, Korean, Dutch, Czech, Portuguese (Europe), Portuguese (Brazil), Japanese, Thai, Turkish, Spanish (Latin America), Spanish (Europe), Hungarian, Italian, Vietnamese |

## Dimensions

Aggregate product size diagram using IPC3618SE-ADF28KM-WL-I0 as an example



## Accessories

|   |   |   |
|---|---|---|
| <p><b>TR-JB03-G-IN</b><br/>Junction Box for Mini Fix-dome(Support wiring from behind)</p> | <p><b>TR-A01-IN</b><br/>NPT 3/4" Waterproof Cable Gland</p>                         | <p><b>TR-SE24-IN</b><br/>Dome Pendent Mounting Pole 200mm</p>   |
|        |  |    |
| <p><b>TR-SE24-A-IN</b><br/>Dome Pendent Mounting Pole 500mm</p>                           | <p><b>TR-CM24-IN</b><br/>Dome Pendent Mounting Bracket(Indoor)</p>                  | <p><b>TR-JB07/WM03-G-IN-V2</b><br/>Wall Mounting Assembling Bracket For 32 Fix-dome&amp;Mini Fix-dome&amp;Plastic Turret Camera</p> |
|        |  |    |

| <b>TR-WM03-D-IN-V2</b><br>Wall Mounting Bracket for 32<br>Fix-dome&Mini Fix-dome&Plastic Turret<br>Camera | <b>TR-UC08-C-V2</b><br>Bullet&Dome Corner Mounting Bracket                        | <b>TR-UP06-C-IN-V2</b><br>Pole Mounting Bracket for Bullet Junction<br>Box Only     |
|---|---|---|
|                          |  |  |

# Unlimited New View

## Zhejiang Uniview Technologies Co., Ltd.



<http://www.uniview.com>



[overseasbusiness@uniview.com](mailto:overseasbusiness@uniview.com); [globalsupport@uniview.com](mailto:globalsupport@uniview.com)



No. 369, Xietong Road, Xixing Sub-district, Binjiang District, Hangzhou City, 310051, Zhejiang Province, China



©2023-2025 Zhejiang Uniview Technologies Co., Ltd. All rights reserved.

\*Product specifications and availability are subject to change without notice.

Despite our best efforts, technical or typographical errors may exist in this document. Uniview cannot be held responsible for any such errors and reserves the right to change the contents of this document without prior notice.