

12MP Ultra HD Infrared Vandal-resistant Fisheye Fixed Dome Camera

IPC86CEB-AF18KC-I0

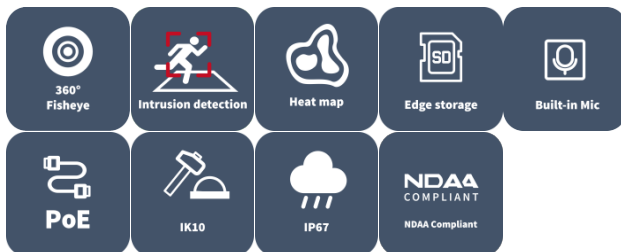

Features

- High quality image with 12 MP, 1/1.7" CMOS sensor
- Max. 4000 × 3000 resolution
- Ultra 265, H.265, H.264, MJPEG
- Ultra wide-angle lens, 360° panoramic image
- Embedded infrared light, 360° fill-in light, up to 15 m (49.2 ft.) IR distance
- Multiple decoding modes, supports software and hardware modes, provides interactive dynamic view
- Heatmap: working with management platform, the data of moving objects is counted in real time on an intuitive color map
- Built-in mic and speaker, supports two-way audio
- MicroSD, up to 512 GB
- IK10 vandal resistant
- IP67 protection

Specifications

Model	IPC86CEB-AF18KC-I0
Camera	
Max Resolution	12 MP
Sensor	1/1.7" CMOS
Min. Illumination	Color: 0.03 Lux (F2.0, AGC ON), 0 Lux with IR
Day/Night	IR-cut filter with auto switch (ICR)
Shutter	Auto/Manual, 1 ~ 1/100000s
S/N	>52 dB
WDR	DWDR
Lens	
Focal Length	1.8 mm
Iris Type	Fixed
Field of View (H)	180°
Field of View (V)	180°
Field of View (D)	180°
Iris	F2.0
Lens Type	Fixed
DORI	
DORI Distance (Lens)	1.8 mm
DORI Distance (Detect)	43.8 m (143.7 ft.)
DORI Distance (Observe)	17.5 m (57.4 ft.)
DORI Distance (Recognize)	8.8 m (28.9 ft.)
DORI Distance (Identify)	4.4 m (14.4 ft.)
Illuminator	
Illumination Distance (IR)	15 m (49.3 ft)
Supplemental Light	IR
IR On/Off Control	Auto/Manual
Wavelength	850 nm
Video	
Main Stream	Fisheye View: 12 MP (4000 × 3000)@20 fps; 3000 × 3000@20 fps; 2560 × 2560@25 fps; Panorama View: 12 MP (4000 × 3000)@20 fps; 3000 × 2000@20/25 fps; 3000 × 1500@20/25 fps; PTZ View: 1920 × 1080@20/25 fps;
Sub Stream	Fisheye View: 2000 × 1500@20 fps; 2000 × 2000@25 fps;
Video Compression	Ultra 265, H.265, H.264, MJPEG
Third Stream	Fisheye View: D1 (720 × 576)@20/25 fps; CIF (352 × 288)@20/25 fps;
H.264 Code Profile	Baseline profile, Main profile, High profile
Video Bit Rate	128 Kbps to 16 Mbps
U-code	Support
OSD	Up to 8 OSDs
Privacy Mask	Up to 4 areas
ROI	Support



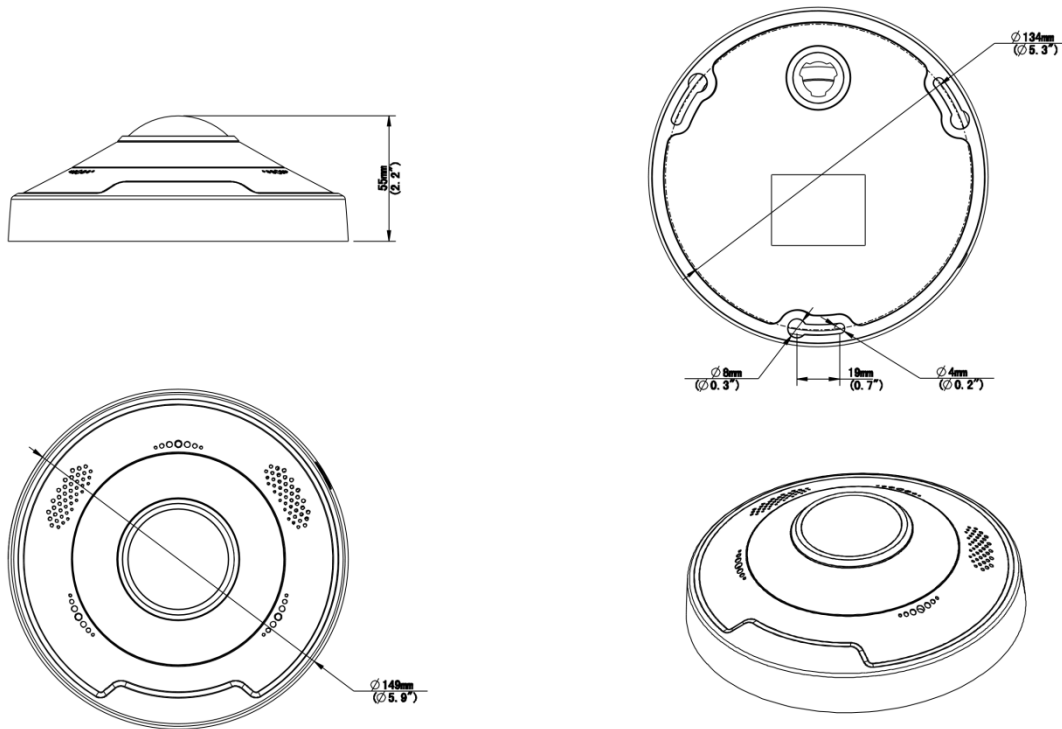

Video Stream	Triple streams
Live View Display	
Hardware Decoding	Ceiling mount: fisheye view, fisheye + 4PTZ, horizontal panorama view, vertical panorama view Table mount: fisheye view, fisheye + 4PTZ, horizontal panorama view, vertical panorama view Wall mount: fisheye view, fisheye + 4PTZ, panorama view
Software Decoding	Ceiling mount: fisheye view, 360° panorama + 1PTZ, 180° panorama view, fisheye + 3PTZ, fisheye + 4PTZ, fisheye + 8PTZ, 360° panorama + 6PTZ Table mount: fisheye view, 360° panorama + 1PTZ, 180° panorama view, fisheye + 3PTZ, fisheye + 4PTZ, fisheye + 8PTZ, 360° panorama + 6PTZ Wall mount: fisheye view, 180° panorama view, 180° panorama view + 3PTZ, 180° panorama view + 4PTZ, 180° panorama view + 8PTZ
Image	
White Balance	Auto, Outdoor, Fine tune, Sodium lamp, Locked, Auto2
Digital Noise Reduction	2D/3D DNR
Smart IR	Support
Flip	Normal, Flip vertical, Flip horizontal, 180°
Dewarping	N/A
HLC	N/A
BLC	Support
Defog	Digital defog
Intelligent	
Smart Intrusion Prevention	Cross line detection, intrusion detection
Statistical Analysis	Heat map (Working with management platform)
Events	
Basic Detection	Motion detection, Tampering alarm, Audio detection
General Function	Watermark, IP address filtering, Access policy, ARP protection, RTSP authentication, User authentication, HTTP authentication
Audio	
Audio Compression	G.711U, G.711A
Audio Bitrate	64 Kbps
Two-way Audio	Support
Suppression	Support
Sampling Rate	8 kHz
Storage	
Edge Storage	MicroSD, up to 512 GB
Network Storage	ANR, NAS (NFS)
Network	
Protocols	IPv4, IPv6, IGMP, ARP, TCP, UDP, DHCP, PPPoE, RTP, RTSP, RTCP, RTMP, DNS, DDNS, NTP, FTP, HTTP, HTTPS, SMTP, 802.1x, SNMP, QoS
Compatible Integration	ONVIF (Profile S, Profile G, Profile T, Profile M), API, SDK
User/Host	Up to 32 users. 3 user levels: administrator, common user and operator
Security	Password Protection, Strong Password, HTTPS Encryption, Export Operation Logs, Basic and Digest Authentication for RTSP, Digest Authentication for HTTP, TLS 1.2, WSSE and Digest

	Authentication for ONVIF
Client	EZStation, APP
Web Browser	Plug-in required live view: IE 10+, Chrome 45+, Firefox 52+, Edge 79+
Interface	
Audio I/O	1 Input: impedance 35 k Ω , amplitude 2 V [p-p], 1 Output: impedance 600 Ω , amplitude 2 V [p-p]
Alarm I/O	2/1
Serial Port	1 \times RS485
Built-in Mic	Built-in dual-mic
Built-in Speaker	Support
Network	1 \times RJ45 10 M/100 M Base-TX Ethernet
Video Output	1 BNC, impedance 75 Ω , amplitude 1 V [p-p]
Certification	
EMC	CE-EMC (EN 55032, EN 61000-3-3, EN IEC 61000-3-2, EN 55035) FCC (FCC 47 CFR part15 B)
Safety	CE LVD (EN 62368-1) CB (IEC 62368-1) UL/CUL (UL 62368-1, CAN/CSA C22.2 No. 62368-1)
Environment	CE-RoHS (2011/65/EU;(EU)2015/863); WEEE (2012/19/EU);
Protection	IP67 (IEC 60529:1989+AMD1:1999+AMD2:2013) IK10 (IEC 62262:2002)
General	
Power	DC 12 V \pm 25%, PoE (IEEE 802.3af)
Power Consumption	Max. 12.0 W
Power Interface	\varnothing 5.5 mm coaxial power plug
Dimensions	\varnothing 149 mm \times 55 mm (\varnothing 5.9" \times 2.2") (\varnothing \times H)
Weight	0.524 kg (1.16 lb.)
Material	Metal + Plastic
Working Environment	-30 $^{\circ}$ C to 60 $^{\circ}$ C (-22 $^{\circ}$ F to 140 $^{\circ}$ F), Humidity: \leq 95% RH (non-condensing)
Storage Environment	-30 $^{\circ}$ C to 60 $^{\circ}$ C (-22 $^{\circ}$ F to 140 $^{\circ}$ F), Humidity: \leq 95% RH (non-condensing)
Surge Protection	4 KV
Reset Button	Support
Web Client Language	20 Languages: Traditional Chinese, English, Simplified Chinese, Polish, German, Russian, French, Korean, Dutch, Czech, Portuguese (Europe), Portuguese (Brazil), Japanese, Thai, Turkish, Spanish (Latin America), Spanish (Europe), Hungarian, Italian, Vietnamese
RTC	Support
Live View	
Maximum Bitstream	20

Dimensions



Accessories

<p>TR-JB04-D-IN Junction Box for Fisheye Fix-dome(Support wiring from behind)</p>	<p>TR-A01-IN NPT 3/4" Waterproof Cable Gland</p>	<p>TR-SE24-IN Dome Pendant Mounting Pole 200mm</p>
		
<p>TR-SE24-A-IN Dome Pendant Mounting Pole 500mm</p>	<p>TR-CM24-IN Dome Pendant Mounting Bracket(Indoor)</p>	
		

Unlimited New View

Zhejiang Uniview Technologies Co., Ltd.



<http://www.uniview.com>



overseasbusiness@uniview.com; globalsupport@uniview.com



No. 369, Xietong Road, Xixing Sub-district, Binjiang District, Hangzhou City, 310051, Zhejiang Province, China



©2023-2025 Zhejiang Uniview Technologies Co., Ltd. All rights reserved.

*Product specifications and availability are subject to change without notice.

Despite our best efforts, technical or typographical errors may exist in this document. Uniview cannot be held responsible for any such errors and reserves the right to change the contents of this document without prior notice.