

Traffic Recording Terminal Server

Quick Guide

1 Packing List

Contact your local dealer if the package is damaged or incomplete. The package contents may vary with device model.

No.	Name	Qty	Unit
1	Traffic Recording Terminal Server	1	PCS
2	Power adapter	1	PCS
3	External power cable	1	PCS
4	External grounding cable	1	PCS
5	SATA power cable	3	PCS
6	SATA data cable	3	PCS
7	Phoenix terminal	2	PCS
8	Anti-vibration washer	12	PCS
9	Flat head screw	12	PCS
10	Heat conducting pad	6	PCS
11	Product documents	1	Set

2 Product Overview

This guide is intended for multiple device models. The device appearance and interfaces may vary with device model.

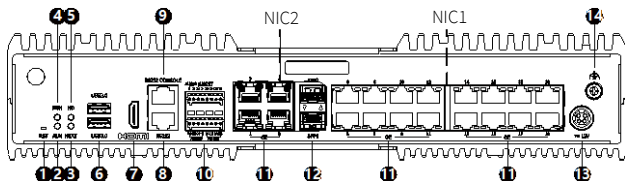

No.	Name	Description
①	RST (reset button)	Press to restart the system. Press and hold for 3 seconds to restore the factory settings and restart.

No.	Name	Description
②	ALM (alarm indicator)	<ul style="list-style-type: none"> ● Steady red: Device alarm occurred (for example, temperature alarm). ● Off: No device alarm.
③	HEAT (heating module indicator)	<ul style="list-style-type: none"> ● Blinking yellow: The heating module is operating. ● Off: The heating module is not started.
④	RUN (operation indicator)	<ul style="list-style-type: none"> ● Steady red: Starting up/abnormal operation. ● Steady green: Normal operation. ● Off: Powered off.
⑤	HD (hard disk indicator)	<ul style="list-style-type: none"> ● Steady green: Normal. ● Blinking green: Reading or writing data. ● Steady red: One abnormal disk. ● Blinking red: Multiple abnormal disks. ● Off: No disk is installed, the disk is not detected, or the disk is not connected to power.
⑥	USB interface	Connects storage devices for files transfer, for example, USB flash drive.
⑦	HDMI output interface	Reserved.
⑧	RS232 interface	Connects RS232 devices for communication.
⑨	RS232 console interface	Connects PC for device test and maintenance.
⑩	Phoenix terminal	<p>Install phoenix terminal connector to connect corresponding cables of external devices.</p> <ul style="list-style-type: none"> ● Alarm input: Connects an alarm input device to receive alarm signal.

No.	Name	Description
		<ul style="list-style-type: none"> ● Alarm output: Connects an alarm output device to send alarm signal. ● 12V power output: Connects external devices to output 12V 1A DC power. ● Grounding terminal: Connects ground with a grounding cable. ● AUDIO: Audio input/output (reserved). ● RS485: Connects RS485 devices for communication.
⑪	Gigabit copper interface	<ul style="list-style-type: none"> ● Connects network with a network cable. ● Connects an IPC to receive data from the IPC. <p>Status:</p> <ul style="list-style-type: none"> ● LINK (network connection indicator): <ul style="list-style-type: none"> ➤ Steady green: Network is connected. ➤ Off: No network connection. ● ACT (data transmission indicator): <ul style="list-style-type: none"> ➤ Blinking yellow: Transmitting data. ➤ Off: No data transmission.
⑫	Gigabit optical interface	<ul style="list-style-type: none"> ● Connects network with a network cable. ● Connects an IPC to receive data from the IPC. <p>Status:</p> <ul style="list-style-type: none"> ● Steady green: Network is connected. ● Off: No network connection.
⑬	Power input interface	Connects the power adapter for 12V DC power input.
⑭	Grounding screw	Connects ground with a grounding cable.

3 Installation



CAUTION!

Before you start, be sure to disconnect power, and wear ESD wrist strap or gloves during the operation; otherwise, it may cause personal injury or device damage.

3.1 Check Before Installation

1 Prepare Tools

- Screwdriver
- ESD wrist strap or gloves

2 Check Environment

- Ensure that the operating temperature is from -30°C to 70°C, and the humidity is from 5% to 95% (noncondensing).
- The power supply meets the requirements indicated on the device, and the power voltage is stable.
- Make sure the device is grounded stably and reliably.

3.2 Install HDDs

Up to four 3.5-inch HDDs are allowed. There is one hard disk at the factory. To install more hard disks for storage expansion, see the following steps.

1 Uninstall Top Cover

Loosen screws on the top of the middle cover, and screws on the sides of L-shape covers, remove the covers, and then place the inside of the L-shape cover facing upward.



CAUTION!

Please be careful to remove the L-shape cover as a hard disk is installed at the factory; otherwise, it may cause the hard disk damage.

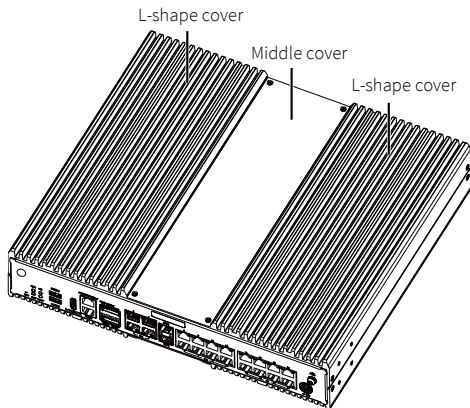

2 Uninstall HDD Mounting Bracket

Loosen screws of the HDD mounting bracket fixed on the inside of the L-shape cover, and then remove the bracket.

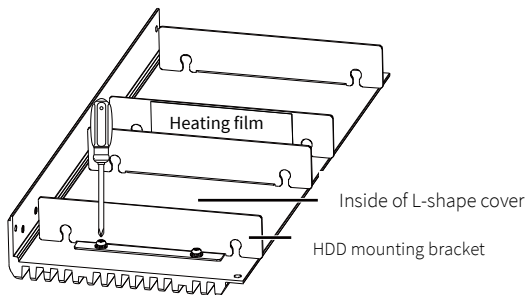

3 Secure HDD

After hard disks re installed, the effect is shown as below. Please check the following items for cables connection and device heat dissipation.

- Divide two HDD mounting brackets into a group, and fix the HDD mounting bracket with heating film to the middle position of the two hard disks.

- Attach the back of the hard disk to the inside of the L-shape cover, and the hard disk interface is facing outward.

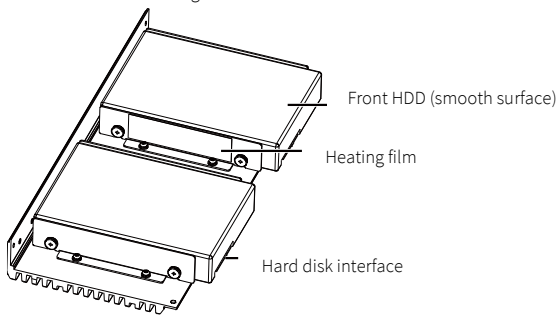

See the following steps for details.

1. Attach the square heat conducting pad to the magnetic head on the back of the HDD, and the rectangular pad to other side of the HDD mounting bracket with the heating film.

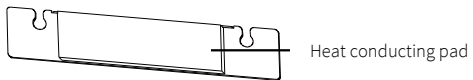
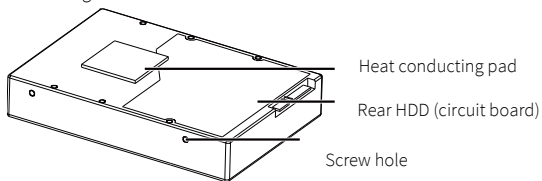

2. Install two anti-vibration washers to grooves of the HDD mounting bracket.

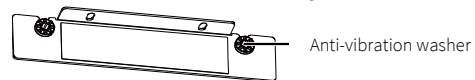

3. Insert flat head screws to the anti-vibration washer holes and tighten them, so as to secure the HDD mounting plate to two sides of HDD (the side with screw holes).

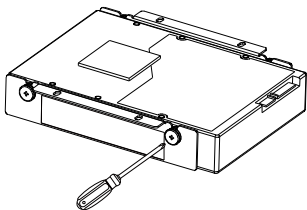

4. Inset the spring washer and flat washer to the screw in sequence, and then secure the HDD mounting bracket to the inside of the L-shape cover with screws.

4 Secure L-Shape Cover

Reinstall the L-shape cover, and tighten the screws on the side panel.

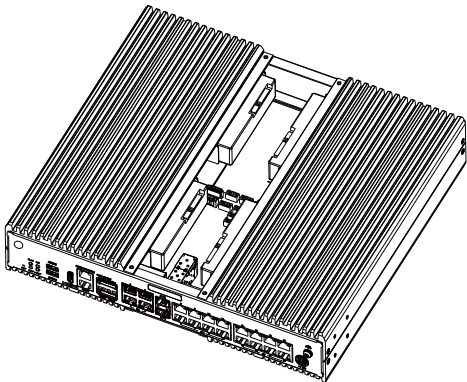

5 Connect HDD Cables

Connect the SATA power cable and SATA data cable to the device, and ensure that the heating film is connected to the heating film power interface.

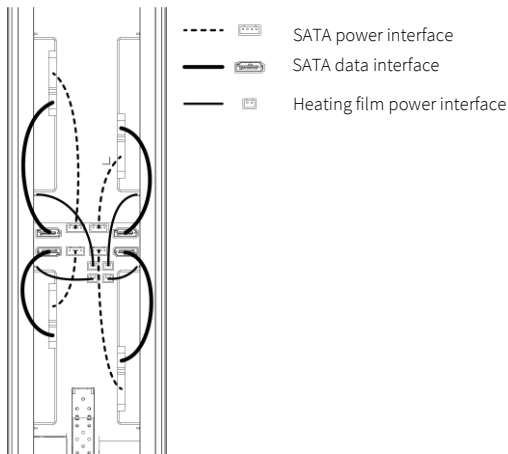

6 Secure Middle Cover

Reinstall the middle cover, and tighten the screws.

3.3 Mount Device

Please place the device in the outdoor electric box or on the indoor workbench, and check the following items:

- The device is firmly and stably placed and far away from vibration sources, such as generators.
- Do not stack devices or put heavy objects on the device.
- When arranging multiple devices in layers, allow more than 10cm space between them for heat dissipation.

3.4 Connect Cables

Connect all cables correctly and related devices, and make sure the device is grounded properly. See [2.2 Interfaces/Indicators](#) for details.

4 Startup/Shutdown

4.1 Startup

Connect one end of the power adapter to the power interface and the other end to the power supply, and then the device will start up.

If the internal temperature detected by the sensor is low, the heating module will automatically operate, and the hard disk indicator is off and the heating indicator is yellow. The device can operate normally after the hard disk indicator is green and the heating indicator is off.

4.2 Shutdown

Disconnect the device from power to shut it down.



CAUTION!

Do not disconnect power when the device is operating or starting up; otherwise, the device may be damaged.

5 Web Login

Log in to the device's Web interface to perform management or maintenance operations.

The default network settings are shown in the table below and may be modified as required.

Item	Defaults
IP address	<ul style="list-style-type: none">● NIC 1: 192.168.1.30● NIC 2: 192.168.2.30 NOTE: DHCP is enabled by default. If a DHCP server is deployed in the network, an IP address may be assigned automatically, and you need to use the assigned IP address to log in.
Username	admin
Password	123456

Item	Defaults
	<p>NOTE:</p> <p>The default password is intended only for your first login. To ensure security, please change the password after your first login. You are strongly recommended to set a strong password of more than eight characters including uppercase and lowercase letters, digits, and special characters. Please note down the new password for next login.</p>

Follow the steps to log in:

1. Open your IE browser (IE10 is recommended), input the device's IP address in the address bar, and then press **Enter** to open the login page.



NOTE:

If you're prompted to install a plug-in, follow the on-screen instructions to complete the installation (close all browsers during installation), and then open the browser again to log in.

2. Enter the username and password, and then click **Login**.

Disclaimer and Safety Warnings

Copyright Statement

©2023-2024 Zhejiang Uniview Technologies Co., Ltd. All rights reserved.

No part of this manual may be copied, reproduced, translated or distributed in any form or by any means without prior consent in writing from Zhejiang Uniview Technologies Co., Ltd (referred to as Uniview or us hereafter).

The product described in this manual may contain proprietary software owned by Uniview and its possible licensors. Unless permitted by Uniview and its licensors, no one is allowed to copy, distribute, modify, abstract, decompile, disassemble, decrypt, reverse engineer, rent, transfer, or sublicense the software in any form by any means.

Trademark Acknowledgements

 are trademarks or registered trademarks of Uniview.



The terms HDMI, HDMI High-Definition Multimedia Interface, HDMI Trade dress and the HDMI Logos are trademarks or registered trademarks of HDMI Licensing Administrator, Inc.

All other trademarks, products, services and companies in this manual or the product described in this manual are the property of their respective owners.

Export Compliance Statement

Uniview complies with applicable export control laws and regulations worldwide, including that of the People's Republic of China and the United States, and abides by relevant regulations relating to the export, re-export and transfer of hardware, software and technology. Regarding the product described in this manual, Uniview asks you to fully understand and strictly abide by the applicable export laws and regulations worldwide.

EU Authorised Representative

UNV Technology EUROPE B.V. Room 2945, 3rd Floor, Randstad 21-05 G, 1314 BD, Almere, Netherlands.

Privacy Protection Reminder

Uniview complies with appropriate privacy protection laws and is committed to protecting user privacy. You may want to read our full privacy policy at our website and get to know the ways we process your personal information. Please be aware, using the product described in this manual may involve the collection of personal information such as face, fingerprint, license plate number, email, phone number, GPS. Please abide by your local laws and regulations while using the product.

About This Manual

- This manual is intended for multiple product models, and the photos, illustrations, descriptions, etc. in this manual may be different from the actual appearances, functions, features, etc. of the product.
- This manual is intended for multiple software versions, and the illustrations and descriptions in this manual may be different from the actual GUI and functions of the software.
- Despite our best efforts, technical or typographical errors may exist in this manual. Uniview cannot be held responsible for any such errors and reserves the right to change the manual without prior notice.
- Users are fully responsible for the damages and losses that arise due to improper operation.
- Uniview reserves the right to change any information in this manual without any prior notice or indication. Due to such reasons as product version upgrade or regulatory requirement of relevant regions, this manual will be periodically updated.

Disclaimer of Liability

- To the extent allowed by applicable law, in no event will Uniview be liable for any special, incidental, indirect, consequential damages, nor for any loss of profits, data, and documents.
- The product described in this manual is provided on an "as is" basis. Unless required by applicable law, this manual is only for informational purpose, and all statements, information, and recommendations in this manual are presented without warranty of any kind, expressed or implied, including, but not limited to, merchantability, satisfaction with quality, fitness for a particular purpose, and noninfringement.
- Users must assume total responsibility and all risks for connecting the product to the Internet, including, but not limited to, network attack, hacking, and virus. Uniview strongly recommends that users take all necessary measures to enhance the protection of network, device, data and personal information. Uniview disclaims any liability related thereto but will readily provide necessary security related support.
- To the extent not prohibited by applicable law, in no event will Uniview and its employees, licensors, subsidiary, affiliates be liable for results arising out of using or inability to use the product or service, including, not limited to, loss of profits and any other commercial damages or losses, loss of data, procurement of substitute goods or services; property damage, personal injury, business interruption, loss of business information, or any special, direct, indirect, incidental, consequential, pecuniary, coverage, exemplary, subsidiary losses, however caused and on any theory of liability, whether in contract, strict liability or tort (including negligence or otherwise) in any way out of the use of the product, even if Uniview has been advised of the possibility of such damages (other than as may be required by applicable law in cases involving personal injury, incidental or subsidiary damage).
- To the extent allowed by applicable law, in no event shall Uniview's total liability to you for all damages for the product described in this manual (other than as may be required by applicable law in cases involving personal injury) exceed the amount of money that you have paid for the product.

Network Security

Please take all necessary measures to enhance network security for your device.

The following are necessary measures for the network security of your device:

- **Change default password and set strong password:** You are strongly recommended to change the default password after your first login and set a strong password of at least nine characters including all three elements: digits, letters and special characters.
- **Keep firmware up to date:** It is recommended that your device is always upgraded to the latest version for the latest functions and better security. Visit Uniview's official website or contact your local dealer for the latest firmware.

The following are recommendations for enhancing network security of your device:

- **Change password regularly:** Change your device password on a regular basis and keep the password safe. Make sure only the authorized user can log in to the device.
- **Enable HTTPS/SSL:** Use SSL certificate to encrypt HTTP communications and ensure data security.
- **Enable IP address filtering:** Allow access only from the specified IP addresses.
- **Minimum port mapping:** Configure your router or firewall to open a minimum set of ports to the WAN and keep only the necessary port mappings. Never set the device as the DMZ host or configure a full cone NAT.
- **Disable the automatic login and save password features:** If multiple users have access to your computer, it is recommended that you disable these features to prevent unauthorized access.
- **Choose username and password discretely:** Avoid using the username and password of your social media, bank, email account, etc, as the username and password of your device, in case your social media, bank and email account information is leaked.
- **Restrict user permissions:** If more than one user needs access to your system, make sure each user is granted only the necessary permissions.
- **Disable UPnP:** When UPnP is enabled, the router will automatically map internal ports, and the system will automatically forward port data, which results in the risks of data leakage. Therefore, it is recommended to disable UPnP if HTTP and TCP port mapping have been enabled manually on your router.
- **SNMP:** Disable SNMP if you do not use it. If you do use it, then SNMPv3 is recommended.
- **Multicast:** Multicast is intended to transmit video to multiple devices. If you do not use this function, it is recommended you disable multicast on your network.
- **Check logs:** Check your device logs regularly to detect unauthorized access or abnormal operations.
- **Physical protection:** Keep the device in a locked room or cabinet to prevent unauthorized physical access.
- **Isolate video surveillance network:** Isolating your video surveillance network with other service networks helps prevent unauthorized access to devices in your security system from other service networks.

Learn More

You may also obtain security information under Security Response Center at Uniview's official website.

Safety Warnings

The device must be installed, serviced and maintained by a trained professional with necessary safety knowledge and skills. Before you start using the device, please read through this guide carefully and make sure all applicable requirements are met to avoid danger and loss of property.

Storage, Transportation, and Use

- Store or use the device in a proper environment that meets environmental requirements, including and not limited to, temperature, humidity, dust, corrosive gases, electromagnetic radiation, etc.
- Make sure the device is securely installed or placed on a flat surface to prevent falling.
- Unless otherwise specified, do not stack devices.
- Ensure good ventilation in the operating environment. Do not cover the vents on the device. Allow adequate space for ventilation.
- Protect the device from liquid of any kind.
- Make sure the power supply provides a stable voltage that meets the power requirements of the device. Make sure the power supply's output power exceeds the total maximum power of all the connected devices.
- Verify that the device is properly installed before connecting it to power.
- Do not remove the seal from the device body without consulting Uniview first. Do not attempt to service the product yourself. Contact a trained professional for maintenance.
- Always disconnect the device from power before attempting to move the device.
- Take proper waterproof measures in accordance with requirements before using the device outdoors.

Power Requirements

- Install and use the device in strict accordance with your local electrical safety regulations.
- Use a UL certified power supply that meets LPS requirements if an adapter is used.
- Use the recommended cordset (power cord) in accordance with the specified ratings.
- Only use the power adapter supplied with your device.
- Use a mains socket outlet with a protective earthing (grounding) connection.
- Ground your device properly if the device is intended to be grounded.

Battery Use Caution

- When battery is used, avoid:
 - Extremely high or low temperature and air pressure during use, storage and transportation.
 - Battery replacement.
- Use the battery properly. Improper use of the battery such as the following may cause risks of fire, explosion or leakage of flammable liquid or gas.
 - Replace battery with an incorrect type.
 - Dispose of a battery into fire or a hot oven, or mechanically crushing or cutting of a battery.
- Dispose of the used battery according to your local regulations or the battery manufacturer's instructions.

Avertissement de l'utilisation de la batterie

- Lorsque utiliser la batterie, évitez:
 - Température et pression d'air extrêmement élevées ou basses pendant l'utilisation, le stockage et le transport.
 - Remplacement de la batterie.
- Utilisez la batterie correctement. Mauvaise utilisation de la batterie comme celles mentionnées ici, peut entraîner des risques d'incendie, d'explosion ou de fuite liquide de gaz inflammables.
 - Remplacer la batterie par un type incorrect.

- Disposer d'une batterie dans le feu ou un four chaud, écraser mécaniquement ou couper la batterie.
- Disposer la batterie utilisée conformément à vos règlements locaux ou aux instructions du fabricant de la batterie.
- **Personal safety warnings:**
 - Chemical Burn Hazard. This product contains a coin cell battery. Do NOT ingest the battery. It can cause severe internal burns and lead to death.
 - Keep new and used batteries away from children.
 - If the battery compartment does not close securely, stop using the product and keep it away from children.
 - If you think batteries might have been swallowed or placed inside any part of the body, seek immediate medical attention.
- **Avertissements de sécurité personnelle:**
 - Risque de brûlure chimique. Ce produit contient une batterie de cellules. N'ingérer pas la batterie. Si la batterie de cellule est avalée, elle peut causer de graves brûlures internes en seulement 2 heures et peut entraîner la mort.
 - Gardez les batteries nouvelles ou utilisées à l'écart des enfants.
 - Si le compartiment de la batterie ne se ferme pas en toute sécurité, cessez d'utiliser le produit et gardez-le à l'écart des enfants.
 - Si vous pensez que des piles ont pu être avalées ou placées à l'intérieur d'une partie du corps, consultez immédiatement un médecin.

Regulatory Compliance

FCC Statements

This device complies with Part 15 of the FCC Rules. Operation is subject to the following two conditions: (1) this device may not cause harmful interference, and (2) this device must accept any interference received, including interference that may cause undesired operation.

Visit http://en.uniview.com/Support/Download_Center/Product_Installation/Declaration/ for SDoC.

Caution: The user is cautioned that changes or modifications not expressly approved by the party responsible for compliance could void the user's authority to operate the equipment.

NOTE: This equipment has been tested and found to comply with the limits for a Class A digital device, pursuant to part 15 of the FCC Rules. These limits are designed to provide reasonable protection against harmful interference when the equipment is operated in a commercial environment. This equipment generates, uses, and can radiate radio frequency energy and, if not installed and used in accordance with the instruction manual, may cause harmful interference to radio communications. Operation of this equipment in a residential area is likely to cause harmful interference in which case the user will be required to correct the interference at his own expense.

LVD/EMC Directive



This product complies with the European Low Voltage Directive 2014/35/EU and EMC Directive 2014/30/EU.

WEEE Directive–2012/19/EU



The product this manual refers to is covered by the Waste Electrical & Electronic Equipment (WEEE) Directive and must be disposed of in a responsible manner.

Battery Directive-2013/56/EU



Battery in the product complies with the European Battery Directive 2013/56/EU. For proper recycling, return the battery to your supplier or to a designated collection point.