

2MP WDR Starlight IR Network MiniPTZ Dome Camera IPC6412LR-X5UPW-VG



Features

- High quality image with 1080P, 1/2.7" CMOS sensor
- 1920 × 1080@30 fps in the main stream
- Ultra 265, H.265, H.264, MJPEG
- 5X optical zoom allows for closer viewing of subjects
- Smart intrusion prevention, supports false alarm filtering, including cross line, intrusion, enter area, leave area detection
- automatic selection of best snapshots
- LightHunter technology ensures ultra-high image quality in low illumination environment
- Up to 120 dB optical WDR (wide dynamic range)
- Wi-Fi connection and easy installation
- Built-in mic and speaker, supports two-way audio
- Alarm I/O: 1/1
- Smart IR, up to 30 m (98.4 ft) IR distance

Specifications

Model	IPC6412LR-X5UPW-VG
Camera	
Sensor	1/2.7" CMOS
Min. Illumination	Color: 0.003 Lux (F1.2, AGC ON), 0 Lux with IR
Day/Night	IR-cut filter with auto switch (ICR)
Shutter	Auto/Manual, 1 to 1/100000 s
WDR	120 dB
S/N	>52dB
Lens	
Focal Length	2.7 to 13.5 mm
Optical Zoom	5X
Iris	F1.2
Field of View (H)	104.9° to 30.6°
Field of View (V)	55.41° to 17.7°
Field of View (D)	136.37° to 36.1°
DORI	
DORI Distance (Lens)	2.7 to 13.5 mm
DORI Distance (Detect)	70.9 m to 247.5 m (232.5 ft. to 812.0 ft.)
DORI Distance (Observe)	28.4 m to 99.0 m (93.2 ft. to 324.8 ft.)
DORI Distance (Recognize)	14.2 m to 49.5 m (46.5 ft. to 162.4 ft.)
DORI Distance (Identify)	7.1 m to 24.8 m (23.3 ft. to 81.4 ft.)
Video	
Privacy Mask	24 areas, up to 4 areas per scene
Video Compression	Ultra 265, H.265, H.264, MJPEG
Frame Rate	Main Stream: 1080P (1920 × 1080), max. 30 fps; Sub Stream: 720P (1280 × 720), max. 30 fps; Third Stream: D1 (720 × 576), max. 30 fps
Video Bit Rate	128 Kbps to 16 Mbps
U-code	Support
ROI	Support
Video Stream	Triple streams
OSD	Up to 8 OSDs
Intelligent	
Smart Intrusion Prevention	Cross line detection, intrusion detection, enter area detection, leave area detection (support false alarm filtering and the classification of human, non-motor vehicle and vehicle)
Exception Detection	Object removed, Object Left Behind, Scene change, Defocus detection
Image	
White Balance	Auto, Outdoor, Fine tune, Sodium lamp, Locked, Auto2
Digital Noise Reduction	2D/3D DNR
Flip	Normal, Flip vertical, Flip horizontal, 180°
HLC	Support





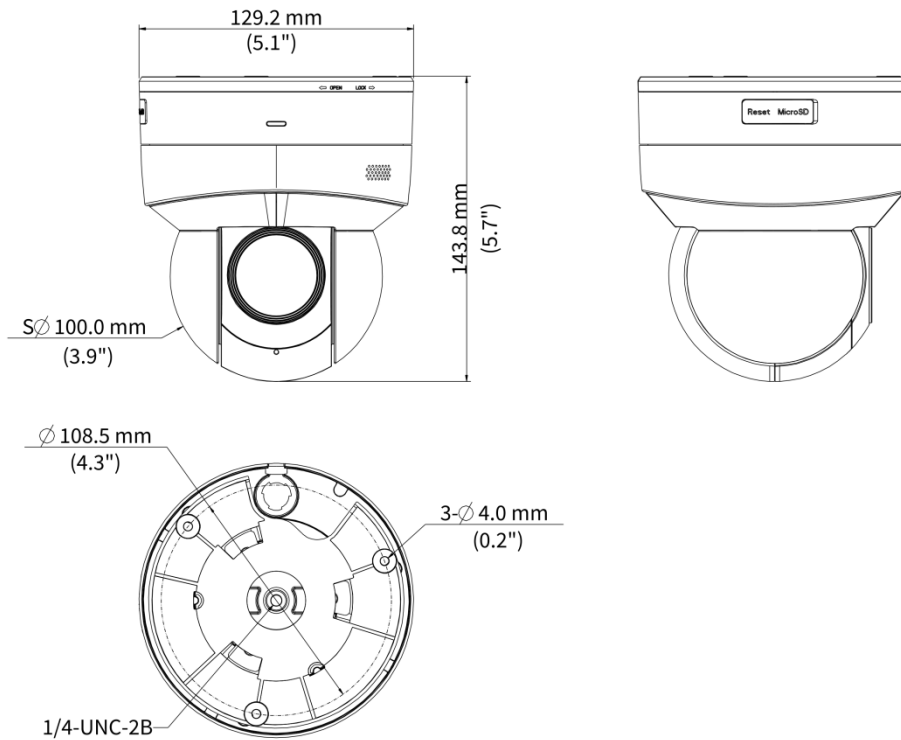

BLC	Support
Smart IR	Support
Defog	Digital defog
Heatwave Reduction	N/A
Illuminator	
Light On/Off Control	Auto/Manual
Wavelength	850 nm
Illumination Distance (IR)	30 m (98.4 ft.)
Events	
Basic Detection	Motion detection, Tampering alarm, Audio detection, Object removed, Object Left Behind, Scene change, Defocus detection
General Function	Watermark, IP address filtering, Alarm input, Alarm output, Access policy, ARP protection, RTSP authentication, User authentication
Audio	
Audio Compression	G.711U, G.711A
Audio Bitrate	128 Kbps
Two-way Audio	Support
Suppression	Support
Sampling Rate	16KHZ
Storage	
Edge Storage	MicroSD, up to 512 GB
Network Storage	ANR, NAS (NFS)
Network	
Protocols	SSH, IGMP, RTP, RTCP, SMTP, IPv4, IPv6, ICMP, ARP, TCP, UDP, DHCP, PPPoE, RTSP, RTMP, DNS, DDNS, NTP, FTP, UPnP, HTTP, HTTPS, 802.1x, SNMP, QoS, SSL/TLS
Compatible Integration	ONVIF (Profile S, Profile G, Profile T), API, SDK
User/Host	Up to 32 users. 3 user levels: administrator, common user and operator
Security	TLS 1.3, Password Protection, Strong Password, HTTPS Encryption, Export Operation Logs, Basic and Digest Authentication for RTSP, Digest Authentication for HTTP, TLS 1.2, WSSE and Digest Authentication for ONVIF
Client	EZStation, UNV-Link, UNV-Link Pro
Web Browser	Plug-in required live view: IE 10+, Chrome 45+, Firefox 52+, Edge 79+
PTZ	
Number of Presets	1024
Preset Patrol	16 patrols, up to 64 presets for each patrol
Patrol Stay Time	1800 s to 3600 s
Preset Image Freeze	N/A
Home Position	Support
Pan Range	350°
Tilt Range	0° to 90°
Pan Speed	0.1°/s to 60°/s
Tilt Speed	0.1°/s to 50°/s
Interface	

Audio I/O	N/A
Alarm I/O	1/1
Serial Port	1 * RS485
Built-in Mic	Support
Built-in Speaker	Support
Network	1 × RJ45 10 M/100 M Base-TX Ethernet
Video Output	N/A
Certification	
EMC	CE-EMC (EN 55032: 2015+A1:2020; EN 61000-3-3: 2013+A1: 2019; EN IEC 61000-3-2: 2019+A1: 2021; EN 55035: 2017+A11:2020) FCC (FCC CFR 47 part15 B, ANSI C63.4-2014)
Safety	CE LVD (EN 62368-1:2014+A11:2017) CB (IEC 62368-1:2014) UL (UL 62368-1, 2nd Ed., Issue Date: 2014-12-01)
Environment	CE-ROHS (2011/65/EU;(EU)2015/863)
General	
Power	DC 12 V (±25%), PoE (IEEE 802.3at)
Power Consumption	Max. 15 W
Power Interface	Ø5.5 mm coaxial power plug
Dimensions	Ø129 mm × 143.6 mm (Ø5.1" × 5.7") (Ø × H)
Weight	0.76 kg (1.67 lb.)
Working Environment	-10 °C to 50 °C (14 °F to 122 °F), Humidity: ≤ 95% RH (non-condensing)
Storage Environment	-40 °C to 70 °C (-40 °F to 158 °F), Humidity: ≤ 95% RH (non-condensing)
Surge Protection	4 KV
Reset Button	Support
Material	Plastic
Web Client Language	22 Languages: Traditional Chinese, English, Simplified Chinese, Polish, German, Russian, French, Korean, Dutch, Czech, Portuguese (Europe), Portuguese (Brazil), Japanese, Thai, Turkish, Spanish (Latin America), Spanish (Europe), Hungarian, Italian, Vietnamese, Arabic, Slovak
Configurable	
P/N	Support

Dimensions



Accessories

<p>TR-JB03-H-IN Junction Box for Metal Turret Camera(Support wiring from behind)</p>	<p>TR-JB07/WM03-F-IN Wall Mounting Assembling Bracket with Back Hole for 3 Inch Hemisphere</p>	<p>TR-WM03-B-IN Wall Mounting Assembling Bracket for 3 Inch Hemisphere</p>
		
<p>TR-A01-IN NPT 3/4" Waterproof Cable Gland</p>	<p>TR-UP06-IN Universal Pole Mounting Bracket</p>	<p>TR-UC08-C Bullet&Dome Corner Mounting Bracket</p>
		

Unlimited New View

Zhejiang Uniview Technologies Co., Ltd.



<http://www.uniview.com>



overseasbusiness@uniview.com; globalsupport@uniview.com



No. 369, Xietong Road, Xixing Sub-district, Binjiang District, Hangzhou City, 310051, Zhejiang Province, China



©2023-2025 Zhejiang Uniview Technologies Co., Ltd. All rights reserved.

*Product specifications and availability are subject to change without notice.

Despite our best efforts, technical or typographical errors may exist in this document. Uniview cannot be held responsible for any such errors and reserves the right to change the contents of this document without prior notice.