

8MP Tri Guard VF Dual light Turret Network Camera IPC3638SE-ADZKMC-WP-I1

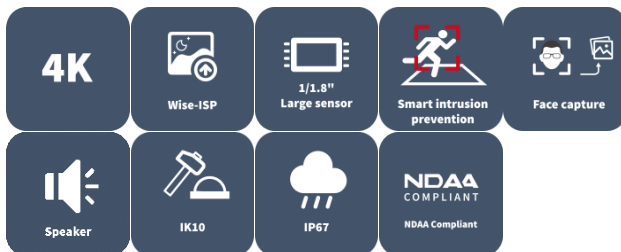

Features

- High quality image with 8 MP, 1/1.8" CMOS sensor
- Features an F1.2 large-aperture lens
- 8 MP (3840 × 2160)@30/25 (default) fps; 5 MP (3072 × 1728)@30/25 fps; 4 MP (2560 × 1440)@30/25 fps; 1080P (1920 × 1080)@30/25 fps
- Ultra 265, H.265, H.264, MJPEG
- ColorHunter with Wise-ISP technology ensures 24-hour full-color images
- Intelligent perimeter protection, including cross line, intrusion, enter area, leave area detection
- Based on target classification, smart intrusion prevention significantly reduces false alarm caused by leaves, birds and lights, accurately focusing on human, motor vehicle and non motor vehicle
- Intelligent people flow counting and crowd density monitoring
- Smart intrusion prevention with color retrieval
- ASM (auto scene match)
- 130 dB true WDR technology enables clear image in strong light scene
- Supports 9:16 corridor mode
- Alarm I/O: 1/1, audio I/O: 1/1, built-in mic and speaker
- Smart IR, up to 30 m (98.4 ft) IR distance
- White light, up to 30 m (98.4 ft) warm light distance
- MicroSD, up to 512 GB
- IK10 vandal resistant and IP67 protection

Specifications

| Model | IPC3638SE-ADZKMC-WP-I1 |
|------------------------------------|---|
| Camera | |
| Max Resolution | 8 MP |
| Sensor | 1/1.8" CMOS |
| Min. Illumination | Color: 0.0005 Lux (F1.2, AGC ON) |
| Day/Night | IR-cut filter with auto switch (ICR) |
| Shutter | Auto/Manual, 1 to 1/100000 s |
| Adjustment Angle | Pan: 0° to 360°, Tilt: 0° to 75°, Rotate: 0° to 360° |
| S/N | > 56 dB |
| WDR | 130 dB |
| Lens | |
| Focal Length | 2.8 to 12 mm |
| Iris Type | Fixed |
| Iris | F1.2 |
| Field of View (H) | 111.5° to 54.1° |
| Field of View (V) | 60.2° to 30.6° |
| Field of View (D) | 128.7° to 61.9° |
| Lens Type | Motorized |
| DORI | |
| DORI Distance (Lens) | 2.8 to 12 mm |
| DORI Distance (Detect) | 63.0 m to 270.0 m (206.7 ft. to 885.8 ft.) |
| DORI Distance (Observe) | 25.2 m to 108.0 m (82.7 ft. to 354.3 ft.) |
| DORI Distance (Recognize) | 12.6 m to 54.0 m (41.3 ft. to 177.2 ft.) |
| DORI Distance (Identify) | 6.3 m to 27.0 m (20.7 ft. to 88.6 ft.) |
| Illuminator | |
| Supplemental Light | Dual light |
| Illumination Distance (IR) | 30 m (98.4 ft.) |
| Illumination Distance (Warm Light) | 30 m (98.4 ft.) |
| IR On/Off Control | Auto/Manual |
| Wavelength | 850 nm |
| Light On/Off Control | Auto/Manual |
| Video | |
| Video Compression | Ultra 265, H.265, H.264, MJPEG |
| H.264 Code Profile | Baseline profile, Main profile, High profile |
| Frame Rate-Main Stream | 8 MP (3840 × 2160), max. 30 fps; 5 MP (3072 × 1728), max. 30 fps; 4 MP (2560 × 1440), max. 30 fps; 1080P (1920 × 1080), max. 30 fps; 720P (1280 × 720), max. 30 fps; |
| Frame Rate-Sub Stream | 1080P (1920 × 1080), max. 30 fps; 720P (1280 × 720), max. 30 fps; D1 (720 × 576), max. 30 fps; 640 × 360, max. 30 fps; 2CIF (704 × 288), max. 30 fps; CIF (352 × 288), max. 30 fps; |
| Frame Rate-Third Stream | D1 (720 × 576), max. 30 fps; 640 × 360, max. 30 fps; 2CIF (704 × 288), max. 30 fps; CIF (352 × 288), max. 30 fps; |





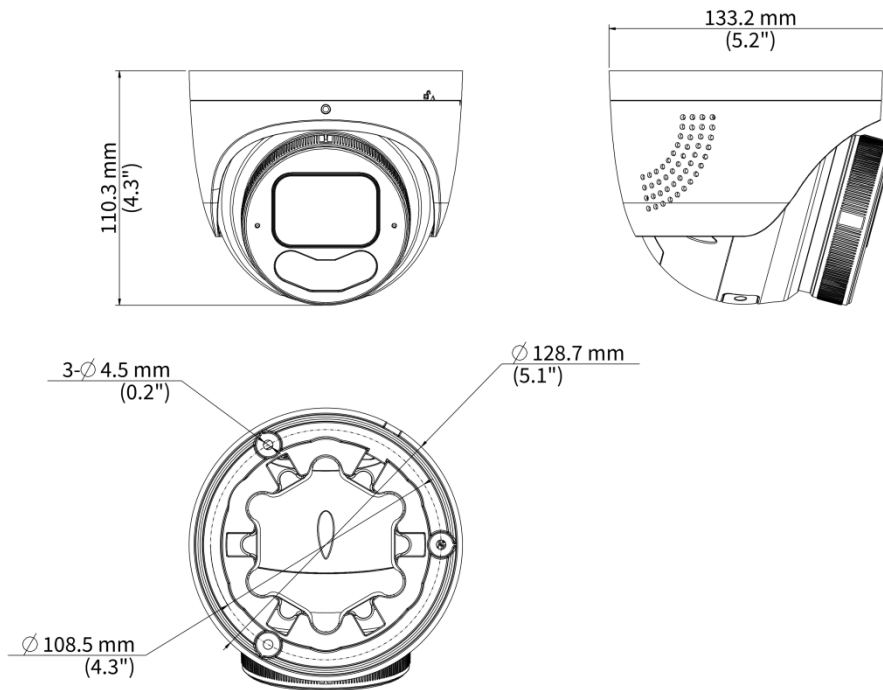

| | |
|----------------------------|--|
| Video Bit Rate | 128 Kbps to 16 Mbps |
| U-code | Support |
| OSD | Up to 8 OSDs |
| Privacy Mask | Up to 4 areas |
| ROI | Support |
| Video Stream | Triple streams |
| Image | |
| White Balance | Auto, Outdoor, Fine tune, Sodium lamp, Locked, Auto2 |
| Digital Noise Reduction | 2D/3D DNR |
| Smart IR | Support |
| Auto Scene Match (ASM) | Support |
| Flip | Normal, Flip vertical, Flip horizontal, 180°, 90° Clockwise, 90° Anti-clockwise |
| Dewarping | N/A |
| HLC | Support |
| BLC | Support |
| Defog | Digital defog |
| Intelligent | |
| Smart Intrusion Prevention | Cross line detection, intrusion detection, enter area detection, leave area detection (support false alarm filtering and the classification of human, non-motor vehicle and vehicle) |
| Statistical Analysis | N/A |
| People Counting | Support people flow counting and crowd density detection |
| Attribute Collection | SIP with color retrieval |
| Events | |
| Basic Detection | Motion detection, Ultra motion detection, Tampering alarm, Audio detection, Object removed, Object Left Behind |
| General Function | Watermark, IP address filtering, Access policy, ARP protection, RTSP authentication, User authentication, HTTP authentication, Alarm input, Alarm output |
| Audio | |
| Audio Compression | G.711U, G.711A |
| Audio Bitrate | 64 Kbps |
| Two-way Audio | Support |
| Suppression | Support |
| Sampling Rate | 8 kHz |
| Storage | |
| Edge Storage | MicroSD, up to 512 GB |
| Network Storage | ANR, NAS (NFS) |
| Network | |
| Protocols | IPv4, IPv6, IGMP, ICMP, ARP, TCP, UDP, DHCP, PPPoE, RTP, RTSP, RTCP, RTMP, DNS, DDNS, NTP, UPnP, HTTP, HTTPS, SMTP, 802.1x, SNMP, QoS, SSL/TLS, SSH |
| Compatible Integration | ONVIF (Profile S, Profile G, Profile T, Profile M), API, SDK |
| User/Host | Up to 32 users. 3 user levels: administrator, common user and operator |
| Client | EZStation, APP |
| Web Browser | Plug-in required live view: IE 10+, Chrome 45+, Firefox 52+, Edge 79+, Plug-in free live view: |

| | |
|----------------------|---|
| | Chrome 57+, Firefox 58+, Edge 16+ |
| Interface | |
| Audio I/O | 1 Input: impedance 35 k Ω , amplitude 2 V [p-p], 1 Output: impedance 600 Ω , amplitude 2 V [p-p] |
| Alarm I/O | 1/1 |
| Serial Port | N/A |
| Built-in Mic | Built-in dual-mic |
| Built-in Speaker | Support |
| WIFI | N/A |
| Network | 1 \times RJ45 10 M/100 M Base-TX Ethernet |
| Video Output | N/A |
| Certification | |
| EMC | CE-EMC (EN 55032, EN 61000-3-3, EN IEC 61000-3-2, EN 50130-4) FCC (FCC 47 CFR part15 B) |
| Safety | CE-LVD (EN 62368-1) UL/CUL (UL 62368-1, CAN/CSA C22.2 No. 62368-1) |
| Environment | CE-RoHS (2011/65/EU ; (EU) 2015/863) ; WEEE (2012/19/EU) |
| Protection | IP67 (IEC 60529) IK10 (IEC 62262) NEMA 4X |
| General | |
| Power | DC 12 V \pm 25%, PoE (IEEE 802.3af) |
| Power Consumption | Max. 7.0 W |
| Power Interface | \varnothing 5.5 mm coaxial power plug |
| Dimensions | \varnothing 129 mm \times 110 mm (\varnothing 5.1" \times 4.3") ($\varnothing \times H$) |
| Weight | 0.99 kg (2.18 lb.) |
| Material | Metal |
| Working Environment | -40 $^{\circ}$ C to 60 $^{\circ}$ C (-40 $^{\circ}$ F to 140 $^{\circ}$ F), Humidity: \leq 95% RH (non-condensing) |
| Storage Environment | -40 $^{\circ}$ C to 60 $^{\circ}$ C (-40 $^{\circ}$ F to 140 $^{\circ}$ F), Humidity: \leq 95% RH (non-condensing) |
| Surge Protection | 4 KV |
| Reset Button | Support |
| Web Client Language | 20 Languages: Traditional Chinese, English, Simplified Chinese, Polish, German, Russian, French, Korean, Dutch, Czech, Portuguese (Europe), Portuguese (Brazil), Japanese, Thai, Turkish, Spanish (Latin America), Spanish (Europe), Hungarian, Italian, Vietnamese |

Dimensions



Accessories

| | | |
|--|--|--|
| <p>TR-JB03-H-IN-V2 Junction Box for Metal Turret Camera(Support wiring from behind)</p> | <p>TR-JB07/WM03-F-IN-V2 Wall Mounting Assembling Bracket with Back Hole for 3 Inch Hemisphere</p> | <p>TR-WM03-B-IN-V2 Wall Mounting Assembling Bracket for 3 Inch Hemisphere</p> |
|  |  |  |
| <p>TR-A01-IN NPT 3/4" Waterproof Cable Gland</p> | <p>TR-UC08-C-V2 Bullet&Dome Corner Mounting Bracket</p> | <p>TR-SE24-IN Dome Pendent Mounting Pole 200mm</p> |
|  |  |  |

| <p>TR-CM24-IN Dome Pendent Mounting Bracket(Indoor)</p> | <p>TR-SE24-A-IN Dome Pendent Mounting Pole 500mm</p> | <p>TR-JB03-J-IN Junction Box for Metal Turret Camera(Support wiring from behind)</p> |
|--|---|---|
| | | |
| <p>TR-UP06-C-IN-V2 Pole Mounting Bracket for Bullet Junction Box Only</p> | | |
| | | |

Unlimited New View

Zhejiang Uniview Technologies Co., Ltd.



<http://www.uniview.com>



overseasbusiness@uniview.com; globalsupport@uniview.com



No. 369, Xietong Road, Xixing Sub-district, Binjiang District, Hangzhou City, 310051, Zhejiang Province, China



©2023-2025 Zhejiang Uniview Technologies Co., Ltd. All rights reserved.

*Product specifications and availability are subject to change without notice.

Despite our best efforts, technical or typographical errors may exist in this document. Uniview cannot be held responsible for any such errors and reserves the right to change the contents of this document without prior notice.