

4MP HD IR VF Dome Network Camera IPC3534LP-ADEZK-DI

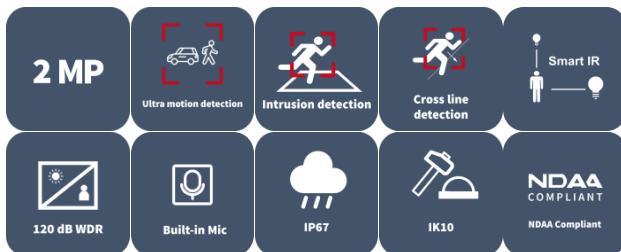

Features

- High quality image with 4 MP, 1/3.0" CMOS sensor
- 4 MP (2688 × 1520)@25/20 fps; 4 MP (2560 × 1440)@25/20 fps; 3 MP (2304 × 1296)@30/25 fps; 1080P (1920 × 1080)@30/25 fps
- Ultra 265, H.265, H.264, MJPEG (Sub Stream Only)
- Smart intrusion prevention, including cross line, intrusion detection (based on human body detection)
- Support ultra motion detection (human/ vehicle detection)
- 120 dB true WDR technology enables clear image in strong light scene
- Built in mic
- Supports 9:16 corridor mode
- Smart IR, up to 40 m (131.2 ft.) IR distance
- MicroSD, up to 512 GB
- IK10 vandal resistant
- IP67 protection

Specifications

| Model | IPC3534LP-ADEZK-DI |
|----------------------------|--|
| Camera | |
| Max Resolution | 4 MP |
| Sensor | 1/3.0" CMOS |
| Min. Illumination | Color: 0.002 Lux (F1.6, AGC ON), 0 Lux with IR on |
| Day/Night | IR-cut filter with auto switch (ICR) |
| Shutter | Auto/Manual, 1 to 1/100000 s |
| Adjustment Angle | Pan: 3° to 360°, Tilt: 0° to 70°, Rotate: 3° to 360° |
| S/N | > 52 dB |
| WDR | 120 dB |
| Lens | |
| Focal Length | 2.8 to 12 mm |
| Iris | F1.6 |
| Field of View (H) | 95.6° to 30.9° |
| Field of View (V) | 52.0° to 17.6° |
| Field of View (D) | 112.2° to 33.7° |
| Lens Type | Motorized |
| Iris Type | DC-iris |
| DORI | |
| DORI Distance (Lens) | 2.8 to 12 mm |
| DORI Distance (Detect) | 42.0 m to 180.0 m (137.8 ft. to 590.6 ft.) |
| DORI Distance (Observe) | 21.0 m to 90.0 m (68.9 ft. to 295.3 ft.) |
| DORI Distance (Recognize) | 10.1 m to 43.2 m (33.1 ft. to 141.7 ft.) |
| DORI Distance (Identify) | 6.3 m to 27.0 m (20.7 ft. to 88.6 ft.) |
| Illuminator | |
| Illumination Distance (IR) | 40 m (131.2 ft.) |
| Wavelength | 850 nm |
| IR On/Off Control | Auto/Manual |
| Video | |
| Video Compression | Ultra 265, H.265, H.264, MJPEG (Sub Stream Only) |
| H.264 Code Profile | Baseline profile, Main profile, High profile |
| Frame Rate | Main Stream: 4 MP (2688 × 1520), max. 25 fps; 4 MP (2560 × 1440), max. 25 fps; 3 MP (2304 × 1296), max. 30 fps; 1080P (1920 × 1080), max. 30 fps; 720P (1280 × 720), max. 30 fps; Sub Stream: 720P (1280 × 720), max. 30 fps; D1 (720 × 576), max. 30 fps; 640 × 360, max. 30 fps; 2CIF (704 × 288), max. 30 fps; CIF (352 × 288), max. 30 fps; |
| Video Bit Rate | 128 Kbps to 6144 Kbps |
| U-code | Support |
| OSD | Up to 4 OSDs |
| Privacy Mask | Up to 4 areas |
| ROI | Support |
| Video Stream | Dual streams |





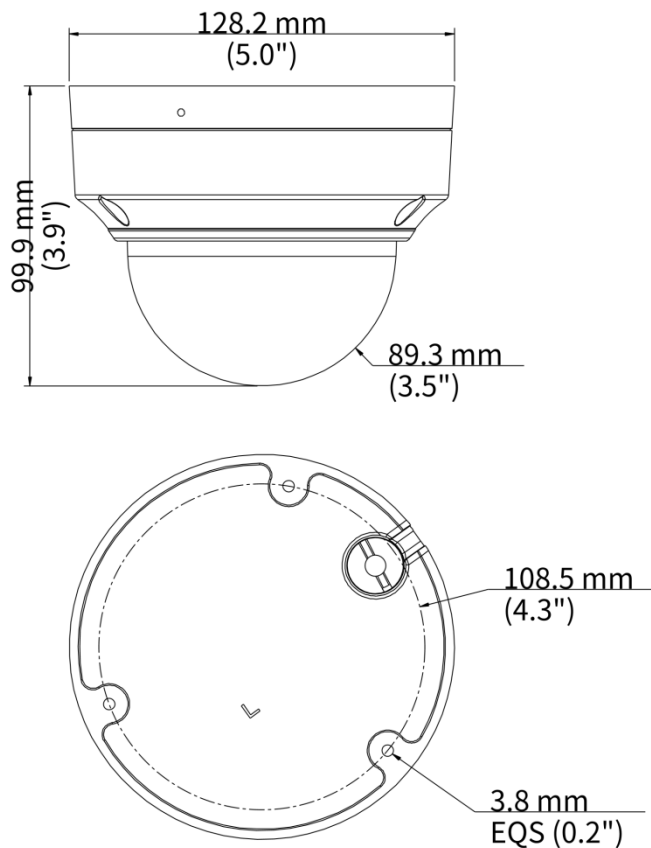

| Image | |
|-------------------------|--|
| White Balance | Auto, Outdoor, Fine tune, Sodium lamp, Locked, Auto2, Area white balance |
| Digital Noise Reduction | 2D/3D DNR |
| Smart IR | Support |
| Flip | Normal, Flip vertical, Flip horizontal, 180°, 90° Clockwise, 90° Anti-clockwise |
| Dewarping | N/A |
| HLC | Support |
| BLC | Support |
| Defog | Digital defog |
| Events | |
| Basic Detection | Motion detection, Ultra motion detection (human/ vehicle detection) , Tampering alarm, Audio detection, Cross line (based on human body detection), Intrusion (based on human body detection) |
| General Function | Watermark, IP address filtering, Access policy, ARP protection, RTSP authentication, User authentication, HTTP authentication |
| Audio | |
| Audio Compression | G.711U, G.711A, AAC-LC |
| Audio Bitrate | G.711U/G.711A: 64 kbps, AAC-LC: 128 kbps |
| Two-way Audio | N/A |
| Suppression | Support |
| Sampling Rate | G.711U/G.711A: 8 kHz, AAC-LC: 8 kHz, 16 kHz, 48 kHz |
| Storage | |
| Edge Storage | MicroSD, up to 512 GB |
| Network Storage | ANR, NAS (NFS) |
| Network | |
| Protocols | IPv4, IPv6, IGMP, ICMP, ARP, TCP, UDP, DHCP, RTP, RTSP, DNS, DDNS, NTP, FTP, UPnP, HTTP, HTTPS, SMTP, SSL/TLS, QoS, SNMP, PPPoE, RTCP, RTMP, 802.1x, SSH |
| Compatible Integration | ONVIF (Profile S, Profile G, Profile T), API, SDK |
| User/Host | Up to 32 users. 3 user levels: administrator, common user and operator |
| Security | Password protection, Strong Password, HTTPS encryption, Export operation logs, Basic and Digest Authentication for RTSP, Digest Authentication for HTTP, TLS 1.2, WSSE and Digest Authentication for ONVIF |
| Client | EZStation, APP |
| Web Browser | Plug-in required live view: IE 10+, Chrome 45+, Firefox 52+, Edge 79+, Plug-in free live view: Chrome 57+, Firefox 58+, Edge 16+ |
| Interface | |
| Audio I/O | 1 Input: impedance 35 k Ω , amplitude 2 V [p-p], 1 Output: impedance 600 Ω , amplitude 2 V [p-p] |
| Alarm I/O | 1/1 |
| Serial Port | N/A |
| Built-in Mic | Support |
| Built-in Speaker | N/A |
| WIFI | N/A |
| Network | 1 \times RJ45 10 M/100 M Base-TX Ethernet |

| | |
|----------------------|---|
| Video Output | N/A |
| Certification | |
| EMC | CE-EMC (EN 55032, EN 61000-3-3, EN IEC 61000-3-2, EN 50130-4) FCC (FCC 47 CFR part15 B) |
| Safety | CE-LVD (EN 62368-1) UL/CUL (UL 62368-1, CAN/CSA C22.2 No. 62368-1) |
| Environment | CE-RoHS (2011/65/EU ; (EU) 2015/863) ; WEEE (2012/19/EU) |
| Protection | IP67 (IEC 60529) IK10 (IEC 62262) |
| General | |
| Power | DC 12 V±25%, PoE (IEEE 802.3af) |
| Power Consumption | Max. 6.5 W |
| Power Interface | Ø5.5 mm coaxial power plug |
| Dimensions | Ø128.2 mm × 99.9 mm (Ø5.0" × 3.9") (Ø × H) |
| Weight | 0.66 kg (1.46 lb.) |
| Material | Metal |
| Working Environment | -30 °C to 60 °C (-22 °F to 140 °F), Humidity: ≤ 95% RH (non-condensing) |
| Storage Environment | -30 °C to 60 °C (-22 °F to 140 °F), Humidity: ≤ 95% RH (non-condensing) |
| Surge Protection | 4 KV |
| Reset Button | Support |
| RTC | Support |
| Web Client Language | 14 Languages: English, Simplified Chinese, Polish, German, Russian, French, Korean, Dutch, Czech, Portuguese, Spanish, Spanish (Europe), Italian, Turkish |

Dimensions



Accessories

| | | |
|--|---|---|
| <p>TR-JB03-H-IN-V2 Junction Box for Metal Turret Camera(Support wiring from behind)</p> | <p>TR-A01-IN NPT 3/4" Waterproof Cable Gland</p> | <p>TR-SE24-IN Dome Pendant Mounting Pole 200mm</p> |
|  |  |  |
| <p>TR-SE24-A-IN Dome Pendant Mounting Pole 500mm</p> | <p>TR-CM24-IN Dome Pendant Mounting Bracket(Indoor)</p> | <p>TR-UC08-C-V2 Bullet&Dome Corner Mounting Bracket</p> |
|  |  |  |

| | | |
|--|--|---|
| <p>TR-JB07/WM03-F-IN-V2 Wall Mounting Assembling Bracket with Back Hole for 3 Inch Hemisphere</p> | <p>TR-WM03-B-IN-V2 Wall Mounting Assembling Bracket for 3 Inch Hemisphere</p> | <p>HS-207S Sunshade Shell for Zoom Dome</p> |
|  |  |  |
| <p>TR-UP06-C-IN-V2 Pole Mounting Bracket for Bullet Junction Box Only</p> | | |
|  | | |

Unlimited New View

Zhejiang Uniview Technologies Co., Ltd.



<http://www.uniview.com>



overseasbusiness@uniview.com; globalsupport@uniview.com



No. 369, Xietong Road, Xixing Sub-district, Binjiang District, Hangzhou City, 310051, Zhejiang Province, China



©2023-2025 Zhejiang Uniview Technologies Co., Ltd. All rights reserved.

*Product specifications and availability are subject to change without notice.

Despite our best efforts, technical or typographical errors may exist in this document. Uniview cannot be held responsible for any such errors and reserves the right to change the contents of this document without prior notice.