

## 2MP Fixed Two-way Audio & Active Deterrence Dual-light Bullet Analog Camera

### UAC-B142-ACF28(40)LM-DL



## Overview

UAC-B142-ACF28(40)LM-DL is a 2MP ColorHunter with smart dual light bullet analog camera with a high-performance 1/3-inch CMOS sensor and 3D noise reduction technology. It supports TVI/AHD/CVI/CVBS, which effectively enhances product adaptability and diversity of networking solutions. With SYV-75-3 or other coaxial cable types, the camera can achieve low-cost, long-distance, and anti-interference mega-pixel HD video transmission without time delay. The ColorHunter camera is equipped with two-way audio communication and strobe light alarm capabilities. Pairing with the Q4-series XVR, the camera allows for real-time communication while actively deterring intruders with lights and alarms when unattended. The system provides real-time alerts to users through coaxial cables, offering a safer living environment.

## Features

Note: To use the two-way audio & active deterrence dual-light analog camera, make sure it is used with our XVR301-04Q4/XVR301-08Q4/XVR301-16Q4, and the XVR must be upgraded to the latest version.

- High quality imaging with 2MP resolution
- TVI/AHD/CVI/CVBS
- Supports IR-cut filter with auto-switch (ICR)
- Two-way audio (Only TVI 1080P)
- Dual-light active deterrence (only TVI)
- Active defense with visual and auditory warnings (Only TVI 1080P)
- High-quality audio through coaxial cables, built-in microphone, and built-in speaker
- 3D noise reduction technology delivers clean and sharp images

- Supports 180° horizontal flip, 180° vertical flip
- OSD configuration menu, easy to operate
- IP67 waterproof and dustproof design, high reliability
- OSD configuration menu in 11 languages

## Specifications





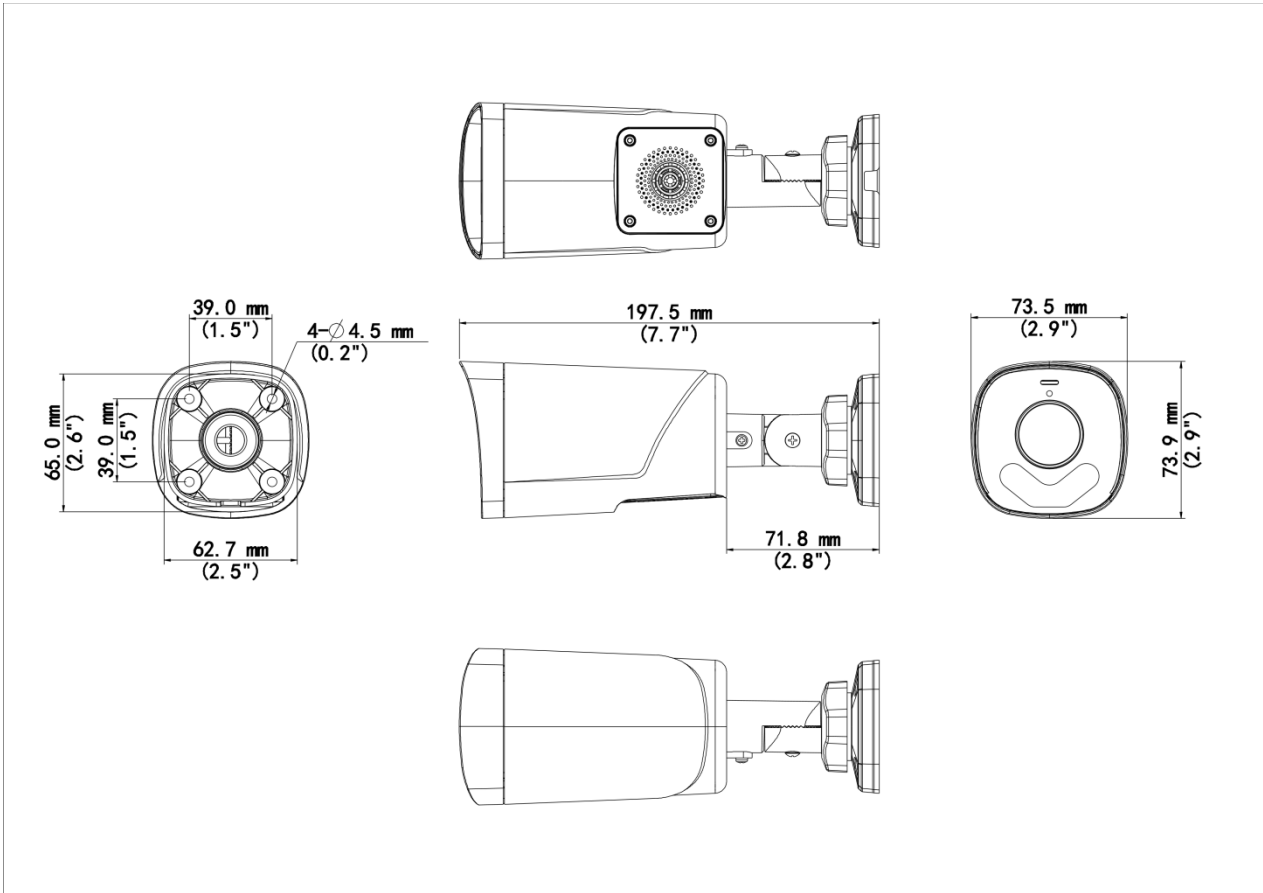

| Model                   | UAC-B142-ACF28LM-DL  | UAC-B142-ACF40LM-DL |
|-------------------------|--|---------------------|
| <b>Camera</b>           |  |                     |
| Max Resolution          | 2 MP   |                     |
| Sensor Size             | 1/3.0" CMOS  |                     |
| Min. Illumination       | 0.003 lux (F1.6, AGC ON)<br>0 lux (Illuminator ON)   |                     |
| <b>Lens</b>             |  |                     |
| Focus                   | 2.8 mm   | 4.0 mm              |
| Lens Mount              | M12  |                     |
| Angle of View (H)       | 96.5°  | 52.0°               |
| Angle of View (V)       | 54.5°  | 31.0°               |
| Angle of View (D)       | 109.5°   | 59.0°               |
| <b>Illuminator</b>      |  |                     |
| Illuminator Number      | Two IR illuminators; Two white-light illuminators  |                     |
| Illumination Distance   | IR: 40m (131.23 ft)<br>White light: 40m (131.23ft)   |                     |
| Lifetime                | ≥ 60000 hours  |                     |
| <b>Video</b>            |  |                     |
| Resolution              | 1080P: 1920(H)×1080(V)<br>720P: 1280(H) ×720(V)  |                     |
| Frame Rate              | TVI: 1080P@25fps (default), 1080P@30fps; 720P@25fps, 720P@30fps<br>AHD: 1080P@25fps, 1080P@30fps; 720P@25fps, 720P@30fps<br>CVI: 1080P@25fps, 1080P@30fps; 720P@25fps, 720P@30fps<br>CVBS: PAL, NTSC |                     |
| Shutter Time            | PAL: 1/25 s-1/50000 s, NTSC: 1/30 s-1/50000 s  |                     |
| <b>Image</b>            |  |                     |
| Exposure Mode           | Four modes: Global (default), BLC, HLC, DWDR   |                     |
| Day/Night               | Three modes: Auto (default), Day, Night  |                     |
| Digital Noise Reduction | 2D/3D  |                     |
| White Balance           | Two modes: Auto (default), Manual  |                     |
| WDR                     | DWDR   |                     |
| Light Mode              | Dual light (default) , Infrared, White light   |                     |
| Flip                    | Supports 180°horizontal flip, 180°vertical flip  |                     |
| Digital Defog           | N/A  |                     |
| <b>Audio</b>            |  |                     |
| Built-in Mic            | Support  |                     |
| Camera Audio            | TVI: 1080P@25fps, 1080P@30fps  |                     |







|                              |  |
|------------------------------|--|
|                              | CVI: 1080P@25fps, 1080P@30fps  |
| Two-way Audio                | Support  |
| <b>Interface</b>             |  |
| Power Interface              | 5.5 mm Power Interface   |
| Video Output                 | BNC, supports TVI/AHD/CVI/CVBS   |
| <b>Operating Environment</b> |  |
| Temperature                  | -30 °C to 60 °C (-22 °F to 140 °F)   |
| Humidity                     | ≤ 95% RH (non-condensing)  |
| Surge Protection             | 4 KV for power, 4 KV for video output interfaces   |
| <b>General</b>               |  |
| Power                        | DC 12 V±25%  |
| Power Consumption            | MAX 5.8W   |
| Mount                        | Corner Mount, Pole Mount   |
| Dimensions                   | 198mm*74mm*74mm (L*W*H)  |
| Material                     | Metal + Plastic  |
| Weight                       | 247g(0.54lb)   |
| OSD Menu Language            | 11 Languages: English, German, Spanish (Latin America), French, Italian, Japanese, Korean, Polish, Portuguese (Brazil), Russian, Turkish |
| <b>Certification</b>         |  |
| EMC                          | CE-EMC (EN 55032, EN 61000-3-3, EN IEC 61000-3-2, EN 50130-4), FCC (FCC 47 CFR part15 B)   |
| Safety                       | CE-LVD (EN IEC 62368-1)  |
| Environment                  | CE-RoHS (2011/65/EU; (EU) 2015/863); WEEE (2012/19/EU)   |
| Protection                   | IP67 (IEC 60529)   |

## Dimensions



## Accessories

|   |   |   |
|---|---|---|
| <p><b>TR-JB05-A-IN</b><br/>Small Bullet Junction Box(Support wiring from behind,Square)</p> | <p><b>TR-UP06-B-IN</b><br/>Bullet Pole Mounting Bracket</p>                         | <p><b>TR-A01-IN</b><br/>NPT 3/4" Waterproof Cable Gland</p>                           |
|          |  |  |
| <p><b>TR-UP06-C-IN-V2</b><br/>Pole Mounting Bracket for Bullet Junction Box Only</p>        | <p><b>TR-UC08-C-V2</b><br/>Bullet&amp;Dome Corner Mounting Bracket</p>              | <p><b>PWR-DC1201A-UK</b><br/>DC12V/1A Wall Plug British Standard Power Adapter</p>    |
|          |  |  |

|  |   |   |
|--|---|---|
| <p><b>PWR-DC1201B-UK</b><br/>UNV DC12V/1A Wall Plug British Standard<br/>Power Adapter(Colorful Bag)</p> | <p><b>PWR-DC1201A-US</b><br/>DC12V/1A Wall Plug American Standard<br/>Power Adapter</p>                   | <p><b>PWR-DC1201B-US</b><br/>UNV DC12V/1A Wall Plug American<br/>Standard Power Adapter(Colorful Bag)</p> |
|                         |                          |                        |
| <p><b>PWR-DC1201A-EU</b><br/>DC12V/1A Wall Plug European Standard<br/>Power Adapter</p>                  | <p><b>PWR-DC1201B-EU</b><br/>UNV DC12V/1A Wall Plug European<br/>Standard Power Adapter(Colorful Bag)</p> | <p><b>PWR-DC1201A-IND</b><br/>UNV DC12V/1A Wall Plug Indian<br/>Standard Power Adapter-Colorful Bag</p>   |
|                         |                          |                        |

# Unlimited New View

## Zhejiang Uniview Technologies Co., Ltd.

 <http://www.uniview.com>

 [overseasbusiness@uniview.com](mailto:overseasbusiness@uniview.com); [globalsupport@uniview.com](mailto:globalsupport@uniview.com)

 No. 369, Xietong Road, Xixing Sub-district, Binjiang District, Hangzhou City, 310051, Zhejiang Province, China



©2023-2025 Zhejiang Uniview Technologies Co., Ltd. All rights reserved.

\*Product specifications and availability are subject to change without notice.

Despite our best efforts, technical or typographical errors may exist in this document. Uniview cannot be held responsible for any such errors and reserves the right to change the contents of this document without prior notice.