

Fixed Dome Network Cameras

Quick Guide



V2.01

Waterproof Requirements

Please waterproof cables in accordance with the following instructions. User shall assume all responsibility for device damage caused by water due to improper waterproof measures.



NOTE!

- Before you start, connect all the needed cables and cut off the copper wires for the cables that you don't use.
- Use waterproof components to protect the network cable. Waterproof the power cable separately if you don't use it. The video cable does not need waterproof treatment.

1. Use insulation tape (not included in the package) to insulate the connection part of each cable.

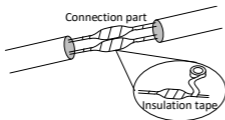

2. Waterproof the cables with self-adhesive waterproof tape.

- (1) Fully stretch the waterproof tape at both ends.
- (2) Wrap the connection part and the cable ends tightly with waterproof tape. Make sure the tape is fully stretched during the process.
- (3) Tighten the tape at both ends to prevent water leakage.

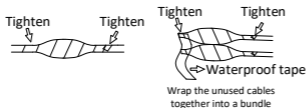

3. Install the supplied waterproof components to the network cable in sequence.

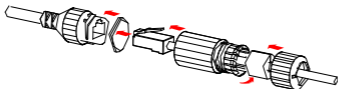

CAUTION!

You need to mount the rubber ring onto the network cable interface first.

4. (Optional) After the waterproof treatment is completed, put the cables into a waterproof junction box (purchased separately).

**CAUTION!**

- The cable connector must not be exposed and must be kept away from water.
- Restore and fasten the device after dismounting.
- Place the power adapter in a power distribution box.

1 Packing List

Contact your local dealer if the package is damaged or incomplete. The package contents may vary with device model.

No.	Name	Qty	Unit
1	Camera	1	PCS
2	Mounting plate	1	PCS
3*	Waterproof components ⁽¹⁾	1	Set
4*	Screws components ⁽²⁾	1	Set
5*	Mount accessories ⁽³⁾	1	Set
6	POE Power adapter	1	PCS
7	Product documents	1	Set

Remarks:

* means optional and supplied with certain models only.

(1) Including one or more waterproof components such as tape and plug.

(2) Including one or more items from screws, hex key, etc.

(3) Including one or more items from drill template, bracket adapter, antistatic gloves, etc.

2 Safety Instructions

2.1 Precautions

- When installing and using the camera, avoid extreme environments such as high temperature, humidity, vibrations, and electromagnetic radiation. Keep it away from heaters, stoves, and bridge undersides.
- Select proper lightning protection devices for the power supply, audio and video cables, and RS485 cables.
- Do not aim the lens to any strong light source such as the sun or an incandescent lamp. It may cause permanent damage to the lens.
- During installation and transportation, special attention is required to protect the transparent dome cover from friction, scratch and stain, etc. Do not remove the protective film from the cover until mounting is finished. Remove the protective film and wipe the dome cover with anti-static gloves before powering on the device.
- If the device is installed on a wall or ceiling, make sure the mounting position is strong enough to withstand the device.

- Do not overbend or drag cables during installation; otherwise, poor cable contact may cause malfunction.
- When connecting to an external interface, use an existing connection terminal, and ensure that the cable terminal (latch or clamp) is in good condition and properly fastened.
- When connecting the alarm input interface, make sure the high level signal of the alarm input does not exceed 5V DC.
- Make sure the length of the power cable between the power adapter and the camera is not too long, otherwise the voltage of the camera is lowered, causing the camera to work abnormally. If it is required to lengthen the power cable, lengthen the cable between the power adapter and the mains.
- Make sure that the power has been disconnected before you maintain or move the device.

2.2 Maintenance

- If there is dust on the front glass surface, remove the dust gently using an oil-free brush or a rubber dust blowing ball.
- If there is grease or a dust stain on the front glass surface, clean the glass surface gently from the center outward using anti-static gloves or an oil-free cloth. If the grease or the stain still remains, use anti-static gloves or an oil-free cloth dipped with detergent and clean the glass surface gently until it is clean.
- Do not use organic solvents (benzene, alcohol, etc.) to clean the transparent dome cover.

3 Appearance

3.1 Dimensions

The appearance and dimensions may vary with device model.

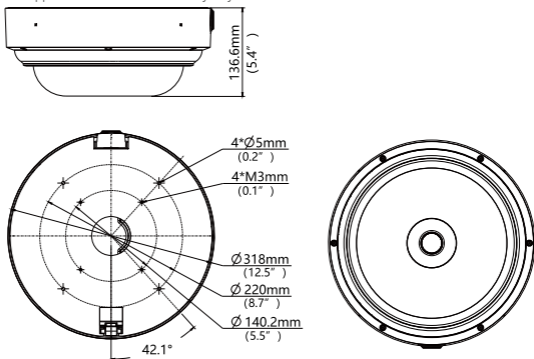

3.2 Tail Cables

The figure below is for illustrative purpose only. The actual tail cables may vary with the camera model.

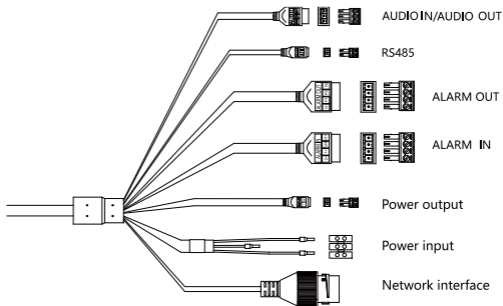

No.	Interface	Description
1	AUDIO IN / AUDIO OUT	<ul style="list-style-type: none"> • Audio input interface, inputs audio signals or starts two-way audio • Audio output interface, output audio signals <p>Note:</p> <p>Audio input and two-way audio share the interface but cannot be used simultaneously.</p>
2	RS485	Serial port, connects external devices for communication, for example, to control third-party devices
3	ALARM OUT	Outputs alarm signals
4	ALARM IN	Receives alarm signals
5	Power output	Power output interface, provides power for other devices
6	Power input	Power input interface, connects the power adapter
7	Network interface	RJ45, 10M/100M /1000M Base-TX self-adaptive Ethernet electrical interface

4 Mount Your Camera

4.1 Tools

- Antistatic gloves or wrist strap.
- (Optional) Marker
- Electric drill
- Philips/Slotted/Torx screwdriver

4.2 (Optional) Insert Micro SD Card

You need to install a Micro SD card first if you want to use the edge storage function.



NOTE!

For recommended SD card specifications, please contact your dealer or technical support.

The figure below is for illustrative purpose only. The actual card slot position may vary.



CAUTION!

Before you insert or remove the Micro SD card, be sure to disconnect power and wait till the camera stops operation; otherwise, the camera and the Micro SD card may be damaged.

1. Loosen the 6 screws on the cover with the supplied hex key or a self-prepared Torx screwdriver, and remove the cover.

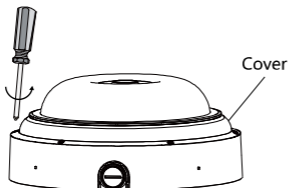

2. Insert a Micro SD card into the card slot.

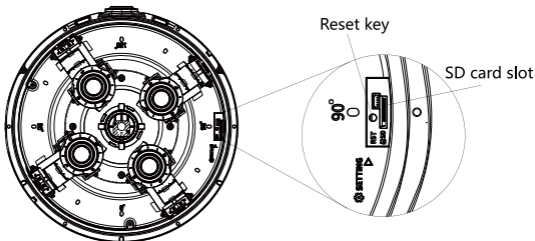

3. Make sure the waterproof ring in the base is in position.
4. Reinstall the cover and tighten the screws until they reach the limit.

**NOTE!**

- The reset operation works only within 10 minutes after the camera is connected to power.
- To restore factory defaults, remove the cover to find the reset button (see the steps above), press and hold the reset button for at least 10 seconds and wait for the device to restart.

4.3 Mount the Camera

The camera supports ceiling mount, wall mount, and pendant mount. The following part takes ceiling mount and wall mount as examples. Pendant mount is similar to wall mount and therefore is omitted here.

4.3.1 Ceiling Mount

1. Locate the positions of the holes and drill holes on the ceiling.

(1) Paste the drill template on the ceiling and lead the cables through the hole.

(2) Use a $\varnothing 6\text{mm}$ drill bit to drill 45mm-depth guide holes according to the template.

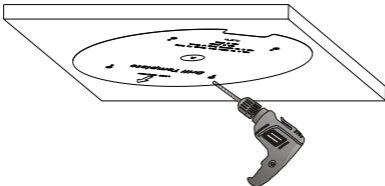

2. Align the guide hole on the ceiling with the hole on the mounting plate, and lead the external cables through the center hole of the mounting plate. Fasten the mounting plate to the ceiling with 4 self-tapping screws using a slotted screwdriver.

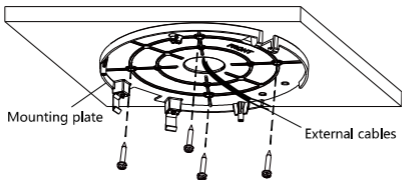
**Note:**

The mounting plate with the **FRONT** logo should face the ground during installation.

3. Loose the 6 screws on the cover with the hex key or a Torx screwdriver, and remove the cover.

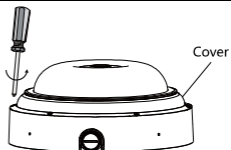

4. Remove the protective foam inside the device and the protective film on the inside of the transparent dome cover.

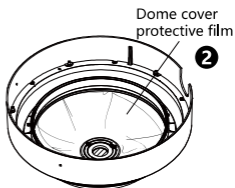
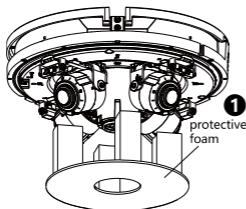

5. Connect all cables.

- (1) Hang the anti-drop cord on the buckle of the mounting plate.
- (2) Hang the base on the end of the mounting plate with a hook.
- (3) Connect external cables and camera tail cables, and hide them in the cavity of the base (waterproof is required).

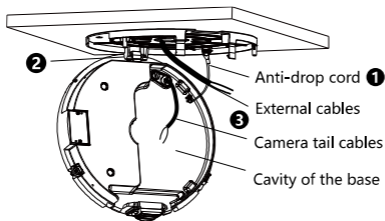

Caution:

- Do not pull hard when leading the tail cables; otherwise, the tail cables may be loose or disconnected.
- The external cables can be led through the side of the base. Please remove the waterproof plug with a slotted screwdriver and install a waterproof connector (self-prepared).

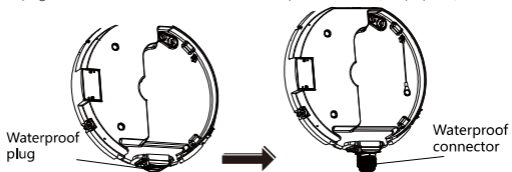

6. Secure the base.

- (1) Adjust the angle of the base until it fully fits the mounting plate, and the quick mount snap will be automatically locked.
- (2) Tighten the screws on both sides of the base with the hex key or a Torx screwdriver (screw holes are shown in ② of the figure below).

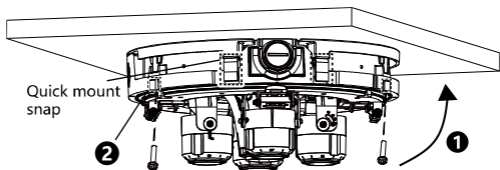

7. Adjust the shooting angle.

- (1) Adjust the horizontal angle by holding the 2 screws at both ends of the light panel and moving the panel left or right to adjust the lens module.

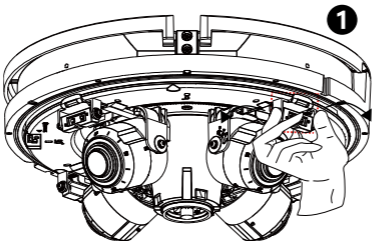

- (2) Adjust the vertical angle by adjusting the vertical bracket.
- (3) Adjust the rotation direction by rotating the lens cover.

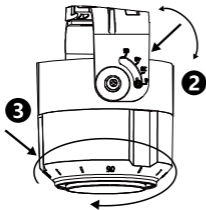

Note:

- The lens angle adjustment supports 0°-65° tilt angle and 0°-90° pan angle. Stop adjusting the lens when it reaches the limit; otherwise, the internal structure will be damaged.
- The SD card slot may be obscured after adjusting the lens. It is recommended to install a Micro SD card before adjusting the lens. See [\(Optional\) Insert Micro SD Card](#) for details.

8. Reinstall the cover, and tighten the 6 screws on the cover with the hex key or a Torx screwdriver until they reach the limit.

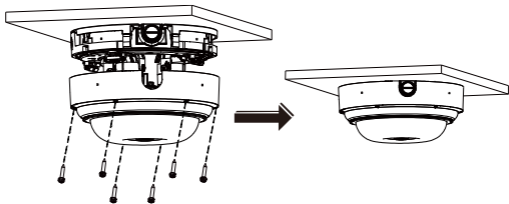

9. Remove the protective films from the outside of the transparent dome cover and the illuminator ring.

Note:

There are 2 pieces of protective films on the illuminator ring. Please remove them from the seam one by one.

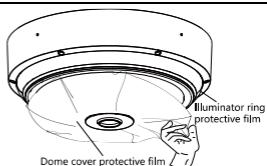

4.3.2 Wall Mount



CAUTION!

- If used outdoors in special circumstances, be sure to apply waterproof treatments. Please note that the user shall assume full responsibility for any damage caused by improper waterproofing measures.
- Make sure all the screws are tightened in place.
- Make sure to perform waterproof treatment on the connection part between the wall vanner gaps, cable outlet on the wall, and tail cable area.

1. Secure the wall mount bracket.

- (1) Locate the positions of the holes according to the 4 screw holes on the bracket. Drill 4 expansion screw holes on the wall and insert the expansion screws.
- (2) Lead cables through the bracket hole.
- (3) Align the bracket holes with the expansion screws, and insert the expansion screws into the bracket holes. Insert the flat washer and hex nuts into the screws, and tighten the hex nuts to secure the bracket on the wall with the hex key.

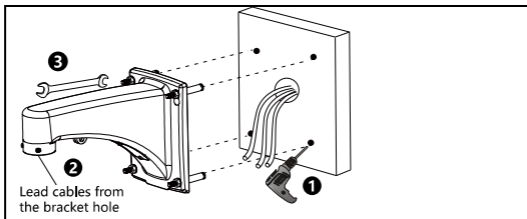

2. Align the holes of the adapter plate (self-prepared) with those of the mounting plate, and secure them with four screws using the hex key or a Torx screwdriver.

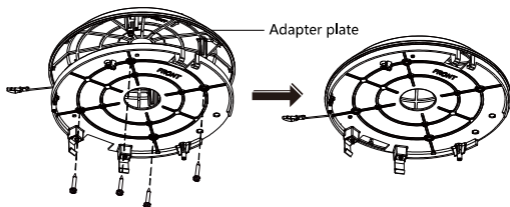

Note:

The adapter plate with the **FRONT** logo should face the ground during installation.

3. Mount the adapter plate.
- (1) Hang the safety rope on the lock nut.
 - (2) Align the locknut on the adapter plate with the wall mount bracket, tighten the locknut in reverse direction (relative to the installation direction of the adapter plate), and tighten the screws on the bracket and the hex nuts on the locknut with the hex key and a Philips screwdriver.

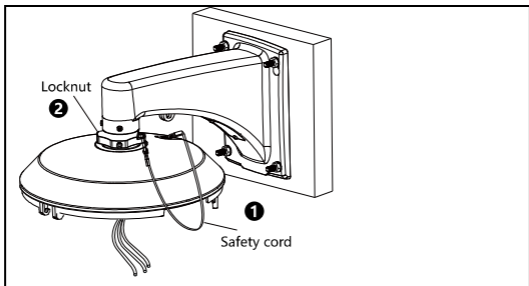

4. Mount the base and cover by referring to the steps 3 to 9 in [Ceiling Mount](#).

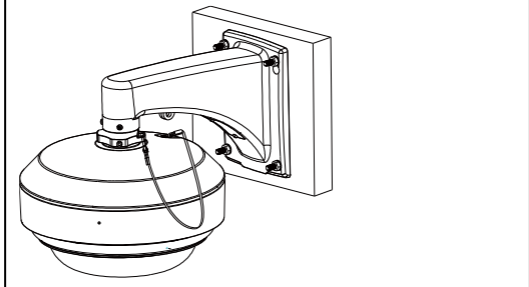

5 Startup

Check that the device is properly installed, and then connect power to start up the device.

6 Web Login

Default IP address:

192.168.1.13

Default
username/password:

admin/123456

Note:

To ensure security, please change the password after your first login. You are strongly recommended to set a strong password of at least nine characters including all three elements: digits, letters and special characters. Change your device password on a regular basis and keep the password safe to ensure that only the authorized user can log in to the device.

Copyright Statement

©2024 Zhejiang Uniview Technologies Co., Ltd. All rights reserved.

No part of this manual may be copied, reproduced, translated or distributed in any form or by any means without prior consent in writing from Zhejiang Uniview Technologies Co., Ltd (referred to as Uniview or us hereafter).

The product described in this manual may contain proprietary software owned by Uniview and its possible licensors. Unless permitted by Uniview and its licensors, no one is allowed to copy, distribute, modify, abstract, decompile, disassemble, decrypt, reverse engineer, rent, transfer, or sublicense the software in any form or by any means.

Trademark Acknowledgements

 are trademarks or registered trademarks of Uniview.

All other trademarks, products, services and companies in this manual or the product described in this manual are the property of their respective owners.

Export Compliance Statement

Uniview complies with applicable export control laws and regulations worldwide, including that of the People's Republic of China and the United States, and abides by relevant regulations relating to the export, re-export and transfer of hardware, software and technology. Regarding the product described in this manual, Uniview asks you to fully understand and strictly abide by the applicable export laws and regulations worldwide.

EU Authorised Representative

UNV Technology EUROPE B.V. Room 2945,3rd Floor,Randstad 21-05 G,1314 BD,Almere,Netherlands.

Privacy Protection Reminder

Uniview complies with appropriate privacy protection laws and is committed to protecting user privacy. You may want to read our full privacy policy at our website and get to know the ways we process your personal information. Please be aware, using the product described in this manual may involve the collection of personal information such as face, fingerprint, license plate number, email, phone number, GPS. Please abide by your local laws and regulations while using the product.

About This Manual

- This manual is intended for multiple product models, and the photos, illustrations, descriptions, etc, in this manual may be different from the actual appearances, functions, features, etc, of the product.
- This manual is intended for multiple software versions, and the illustrations and descriptions in this manual may be different from the actual GUI and functions of the software.
- Despite our best efforts, technical or typographical errors may exist in this manual. Uniview cannot be held responsible for any such errors and reserves the right to change the manual without prior notice.
- Users are fully responsible for the damages and losses that arise due to improper operation.
- Uniview reserves the right to change any information in this manual without any prior notice or indication. Due to such reasons as product version upgrade or regulatory requirement of relevant regions, this manual will be periodically updated.

Disclaimer of Liability

- The product described in this manual is provided on an "as is" basis. Unless required by applicable law, this manual is only for informational purpose, and all statements, information, and recommendations in this manual are presented without warranty of any kind, expressed or implied, including, but not limited to, merchantability, satisfaction with quality, fitness for a particular purpose, and noninfringement.

- To the extent allowed by applicable law, in no event shall Uniview's total liability to you for all damages for the product described in this manual (other than as may be required by applicable law in cases involving personal injury) exceed the amount of money that you have paid for the product.
- Users must assume total responsibility and all risks for connecting the product to the Internet, including, but not limited to, network attack, hacking, and virus. Uniview strongly recommends that users take all necessary measures to enhance the protection of network, device, data and personal information. Uniview disclaims any liability related thereto but will readily provide necessary security related support.
- To the extent not prohibited by applicable law, in no event will Uniview and its employees, licensors, subsidiary, affiliates be liable for results arising out of using or inability to use the product or service, including, not limited to, loss of profits and any other commercial damages or losses, loss of data, procurement of substitute goods or services; property damage, personal injury, business interruption, loss of business information, or any special, direct, indirect, incidental, consequential, pecuniary, coverage, exemplary, subsidiary losses, however caused and on any theory of liability, whether in contract, strict liability or tort (including negligence or otherwise) in any way out of the use of the product, even if Uniview has been advised of the possibility of such damages (other than as may be required by applicable law in cases involving personal injury, incidental or subsidiary damage).

Network Security

Please take all necessary measures to enhance network security for your device.

The following are necessary measures for the network security of your device:

- **Change default password and set strong password:** You are strongly recommended to change the default password after your first login and set a strong password of at least nine characters including all three elements: digits, letters and special characters.
- **Keep firmware up to date:** It is recommended that your device is always upgraded to the latest version for the latest functions and better security. Visit Uniview's official website or contact your local dealer for the latest firmware.
- **The following are recommendations for enhancing network security of your device:**
- **Change password regularly:** Change your device password on a regular basis and keep the password safe. Make sure only the authorized user can log in to the device.
- **Enable HTTPS/SSL:** Use SSL certificate to encrypt HTTP communications and ensure data security.
- **Enable IP address filtering:** Allow access only from the specified IP addresses.
- **Minimum port mapping:** Configure your router or firewall to open a minimum set of ports to the WAN and keep only the necessary port mappings. Never set the device as the DMZ host or configure a full cone NAT.
- **Disable the automatic login and save password features:** If multiple users have access to your computer, it is recommended that you disable these features to prevent unauthorized access.
- **Choose username and password discretely:** Avoid using the username and password of your social media, bank, email account, etc, as the username and password of your device, in case your social media, bank and email account information is leaked.
- **Restrict user permissions:** If more than one user needs access to your system, make sure each user is granted only the necessary permissions.
- **Disable UPnP:** When UPnP is enabled, the router will automatically map internal ports, and the system will automatically forward port data, which results in the risks of data leakage. Therefore, it is recommended to disable UPnP if HTTP and TCP port mapping have been enabled manually on your router.
- **Multicast:** Multicast is intended to transmit video to multiple devices. If you do not use this function, it is recommended you disable multicast on your network.
- **Check logs:** Check your device logs regularly to detect unauthorized access or abnormal operations.
- **Isolate video surveillance network:** Isolating your video surveillance network with other service networks helps prevent unauthorized access to devices in your security system from other service networks.

- **Physical protection:** Keep the device in a locked room or cabinet to prevent unauthorized physical access.
- **SNMP:** Disable SNMP if you do not use it. If you do use it, then SNMPv3 is recommended.

Learn More

You may also obtain security information under Security Response Center at Uniview's official website.

Safety Warnings

The device must be installed, serviced and maintained by a trained professional with necessary safety knowledge and skills. Before you start using the device, please read through this guide carefully and make sure all applicable requirements are met to avoid danger and loss of property.

Storage, Transportation, and Use

- Store or use the device in a proper environment that meets environmental requirements, including and not limited to, temperature, humidity, dust, corrosive gases, electromagnetic radiation, etc.
- Make sure the device is securely installed or placed on a flat surface to prevent falling.
- Unless otherwise specified, do not stack devices.
- Ensure good ventilation in the operating environment. Do not cover the vents on the device. Allow adequate space for ventilation.
- Protect the device from liquid of any kind.
- Make sure the power supply provides a stable voltage that meets the power requirements of the device. Make sure the power supply's output power exceeds the total maximum power of all the connected devices.
- Verify that the device is properly installed before connecting it to power.
- Do not remove the seal from the device body without consulting Uniview first. Do not attempt to service the product yourself. Contact a trained professional for maintenance.
- Always disconnect the device from power before attempting to move the device.
- Take proper waterproof measures in accordance with requirements before using the device outdoors.

Power Requirements

- Install and use the device in strict accordance with your local electrical safety regulations.
- Use a UL certified power supply that meets LPS requirements if an adapter is used.
- Use the recommended cordset (power cord) in accordance with the specified ratings.
- Only use the power adapter supplied with your device.
- Use a mains socket outlet with a protective earthing (grounding) connection.
- Ground your device properly if the device is intended to be grounded.

Battery Use Caution

- When battery is used, avoid:
 - Extremely high or low temperature and air pressure during use, storage and transportation.
 - Battery replacement.
- Use the battery properly. Improper use of the battery such as the following may cause risks of fire, explosion or leakage of flammable liquid or gas.
 - Replace battery with an incorrect type;
 - Dispose of a battery into fire or a hot oven, or mechanically crushing or cutting of a battery;
- Dispose of the used battery according to your local regulations or the battery manufacturer's instructions.

Avertissement de l'utilisation de la batterie

- Lorsque utiliser la batterie, évitez:
 - Température et pression d'air extrêmement élevées ou basses pendant l'utilisation, le stockage et le transport.
 - Remplacement de la batterie.
- Utilisez la batterie correctement. Mauvaise utilisation de la batterie comme celles mentionnées ici, peut entraîner des risques d'incendie, d'explosion ou de fuite liquide de gaz inflammables.
 - Remplacer la batterie par un type incorrect;
 - Disposer d'une batterie dans le feu ou un four chaud, écraser mécaniquement ou couper la batterie;

- Disposer la batterie utilisée conformément à vos règlements locaux ou aux instructions du fabricant de la batterie.

Regulatory Compliance

FCC Statements

This device complies with Part 15 of the FCC Rules. Operation is subject to the following two conditions: (1) this device may not cause harmful interference, and (2) this device must accept any interference received, including interference that may cause undesired operation.

Visit http://en.uniview.com/Support/Download_Center/Product_Installation/Declaration/ for SDoC.

Caution: The user is cautioned that changes or modifications not expressly approved by the party responsible for compliance could void the user's authority to operate the equipment.

NOTE: This equipment has been tested and found to comply with the limits for a Class A digital device, pursuant to part 15 of the FCC Rules. These limits are designed to provide reasonable protection against harmful interference when the equipment is operated in a commercial environment. This equipment generates, uses, and can radiate radio frequency energy and, if not installed and used in accordance with the instruction manual, may cause harmful interference to radio communications. Operation of this equipment in a residential area is likely to cause harmful interference in which case the user will be required to correct the interference at his own expense.

LVD/EMC Directive



This product complies with the European Low Voltage Directive 2014/35/EU and EMC Directive 2014/30/EU.

WEEE Directive–2012/19/EU



The product this manual refers to is covered by the Waste Electrical & Electronic Equipment (WEEE) Directive and must be disposed of in a responsible manner.

Battery Regulation- (EU) 2023/1542



Battery in the product complies with the European Battery Regulation (EU) 2023/1542. For proper recycling, return the battery to your supplier or to a designated collection point.