

Bullet Wall Mount
TR-WM06-C-IN

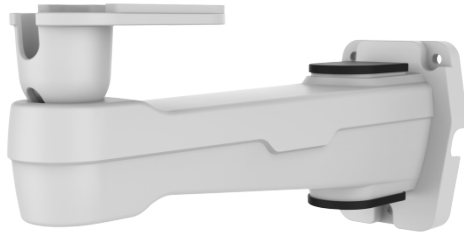

Specifications



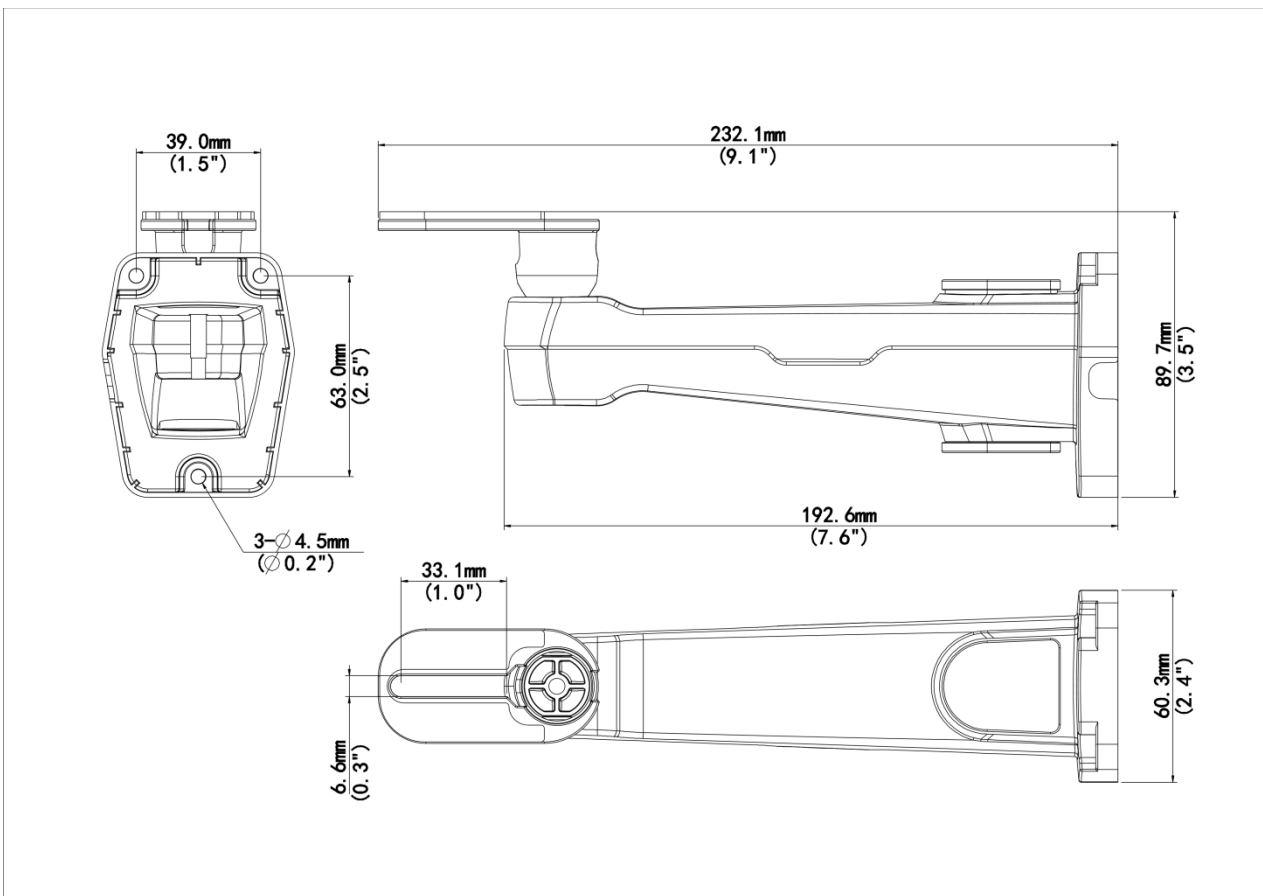

Model	TR-WM06-C-IN
Bracket	
Application	wall installation for Bullet
Bracket Material	Aluminum alloy
Bracket Dimensions	232.1 mm × 60.3 mm × 89.7 mm (9.1" × 2.4" × 3.5")
Bracket Weight	0.2 kg (0.44 lb)

Dimensions

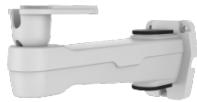

Accessories

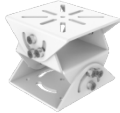
HS-217S-B-NB	HS-217SHB-B-NB	HS-217SHB-IR-B-NB
17" Outdoor Box Camera Housing(Standard Edition)	Outdoor Enhanced Integrated Housing(17 Inch,Plastic Sunshade)	Outdoor Enhanced IR Integrated Housing(17 Inch,Plastic Sunshade,IR)

<p>TR-WM06-C-IN Wall Mounting Bracket for 6-inch Bullet Camera</p>	<p>TR-UM06-A-IN Bullet Camera Desktop Bracket</p>	<p>TR-WM06-I-IN Wall Mounting Bracket for 28&29Housing</p>
		
<p>TR-UV06-A-IN 3D Adjustable Mounting Bracket</p>	<p>TR-UP06-IN Universal Pole Mounting Bracket</p>	
		

Unlimited New View

Zhejiang Uniview Technologies Co., Ltd.



<http://www.uniview.com>



overseasbusiness@uniview.com; globalsupport@uniview.com



No. 369, Xietong Road, Xixing Sub-district, Binjiang District, Hangzhou City, 310051, Zhejiang Province, China



©2023-2025 Zhejiang Uniview Technologies Co., Ltd. All rights reserved.

*Product specifications and availability are subject to change without notice.

Despite our best efforts, technical or typographical errors may exist in this document. Uniview cannot be held responsible for any such errors and reserves the right to change the contents of this document without prior notice.