

## 2MP WDR VF IR Dome Network Camera

### IPC-D312-ADZK



## Features

- High quality image with 1080P, 1/2.7" CMOS sensor
- 1080P (1920 × 1080)@30/25 fps; 720P (1280 × 720)@30/25 fps
- Ultra 265, H.265, H.264,MJPEG
- 2D/3D DNR (digital noise reduction)
- Support ultra motion detection(human/ vehicle detection)
- ROI (region of interest) ensures image quality in areas of interest with low bandwidth
- Smart IR, up to 30 m (98.4 ft.) IR distance
- 120 dB true WDR technology enables clear image in strong light scene
- Built-in mic
- Wide temperature range: -30 °C to 60 °C (-22 °F to 140 °F)
- DC 12 V, PoE (IEEE 802.3af) power supply
- IP67

## Specifications

| Model                      | IPC-D312-ADZK   |
|----------------------------|---|
| <b>Camera</b>              |   |
| Max Resolution             | 2 MP  |
| Sensor                     | 1/2.7" CMOS   |
| Min. Illumination          | Color: 0.005 Lux (F1.6, AGC ON), 0 Lux with IR on   |
| Day/Night                  | IR-cut filter with auto switch (ICR)  |
| Shutter                    | Auto/Manual, 1 ~ 1/100000s  |
| Adjustment Angle           | Pan: 3° to 360°, Tilt: 0° to 70°, Rotate: 3° to 360°  |
| S/N                        | >52 dB  |
| WDR                        | 120 dB  |
| <b>Lens</b>                |   |
| Focal Length               | 2.8 to 12 mm  |
| Iris                       | F1.6  |
| Field of View (H)          | 111.0° to 36.6°   |
| Field of View (V)          | 59.4° to 20.6°  |
| Field of View (D)          | 130.0° to 42.0°   |
| <b>DORI</b>                |   |
| DORI Distance (Lens)       | 2.8 to 12 mm  |
| DORI Distance (Detect)     | 42.0 m to 180 m (137.8 ft. to 590.6 ft.)  |
| DORI Distance (Observe)    | 16.8 m to 72.0 m (55.1 ft. to 236.2 ft.)  |
| DORI Distance (Recognize)  | 8.4 m to 36 m (27.6 ft. to 118.1 ft.)   |
| DORI Distance (Identify)   | 4.2 m to 18 m (13.8 ft. to 59.1 ft.)  |
| <b>Illuminator</b>         |   |
| Supplemental Light         | IR  |
| Illumination Distance (IR) | 30 m (98.4 ft.)   |
| Wavelength                 | 850 nm  |
| IR On/Off Control          | Auto/Manual   |
| <b>Video</b>               |   |
| Video Compression          | H.265, H.264, MJPEG, Ultra 265  |
| H.264 Code Profile         | Baseline profile, Main profile, High profile  |
| Frame Rate                 | Main Stream: 1080P (1920 × 1080), max. 30 fps; 720P (1280 × 720), max. 30 fps<br>Sub Stream: 720P (1280 × 720), max. 30 fps; D1 (720 × 576), max. 30 fps; 640 × 360, max. 30 fps;<br>2CIF (704 × 288), max. 30 fps; CIF (352 × 288), max. 30 fps; |
| Video Bit Rate             | 128 Kbps to 6144 Kbps   |
| U-code                     | Support   |
| OSD                        | Up to 4 OSDs  |
| Privacy Mask               | Up to 4 areas   |
| ROI                        | Up to 8 areas   |
| Video Stream               | Dual streams  |
| <b>Image</b>               |   |







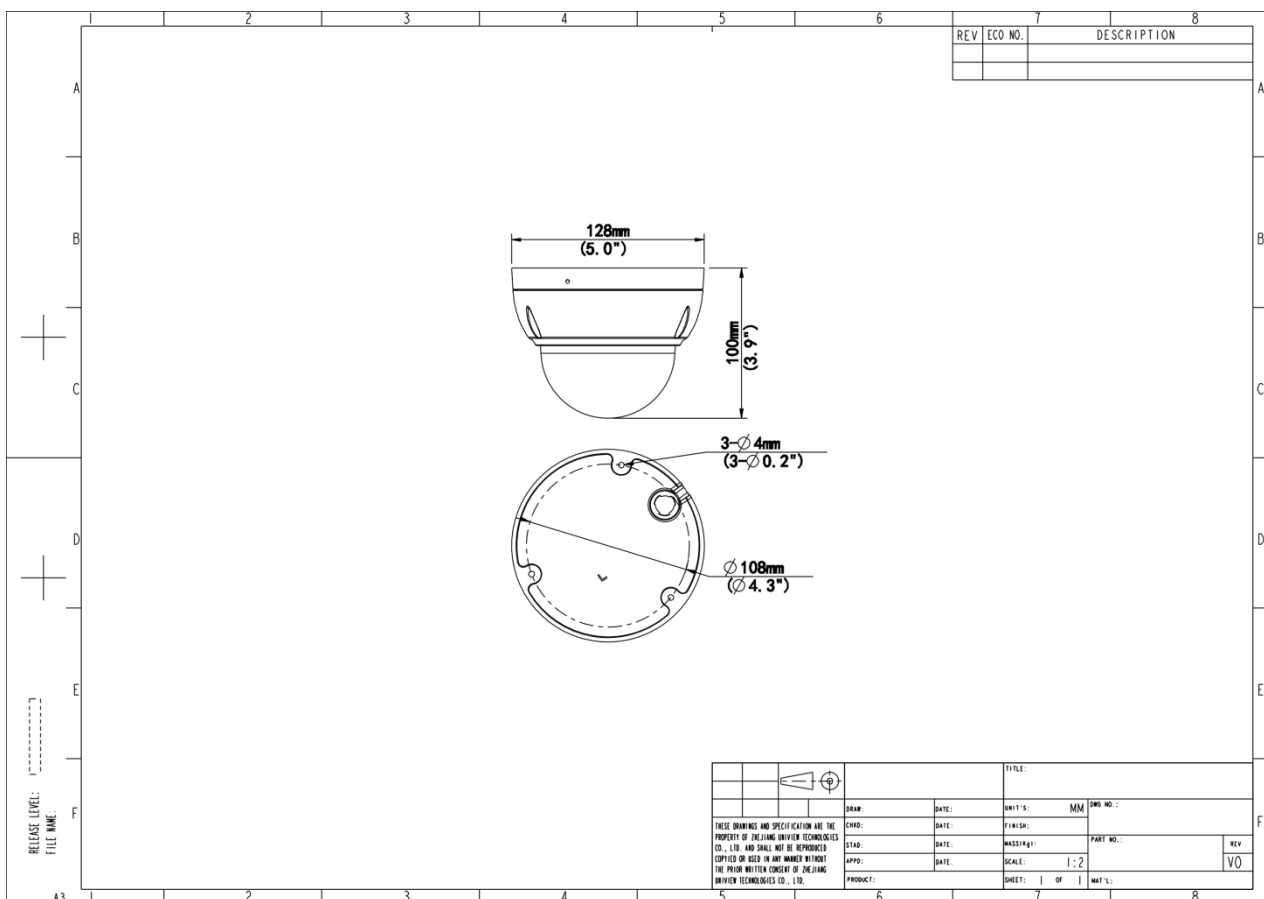



|                         |   |
|-------------------------|---|
| White Balance           | Auto, Outdoor, Fine tune, Sodium lamp, Locked, Auto2  |
| Smart IR                | Support   |
| Digital Noise Reduction | 2D/3D DNR   |
| Flip                    | Normal, Flip vertical, Flip horizontal, 180°, 90° Clockwise, 90° Anti-clockwise   |
| Dewarping               | N/A   |
| HLC                     | Support   |
| BLC                     | Support   |
| Defog                   | Digital defog   |
| <b>Events</b>           |   |
| Basic Detection         | Motion detection, Tampering alarm, Audio detection, Cross line, Intrusion (based on human body detection), Ultra motion detection (human/ vehicle detection)    |
| General Function        | Watermark, IP address filtering, Access policy, ARP protection, RTSP authentication, User authentication, HTTP authentication                                   |
| <b>Audio</b>            |   |
| Audio Compression       | G.711U, G.711A  |
| Audio Bitrate           | 64 Kbps   |
| Two-way Audio           | N/A   |
| Suppression             | Support   |
| Sampling Rate           | 8 kHz   |
| <b>Storage</b>          |   |
| Edge Storage            | MicroSD, up to 512 GB   |
| Network Storage         | ANR, NAS (NFS)  |
| <b>Network</b>          |   |
| Protocols               | IPv4, IGMP, ICMP, ARP, TCP, UDP, DHCP, RTP, RTSP, RTCP, RTMP, DNS, DDNS, NTP, FTP, UPnP, HTTP, HTTPS, SMTP, SSL/TLS, QoS, SNMP, IPv6                            |
| Compatible Integration  | ONVIF (Profile S, Profile G, Profile T), API, SDK   |
| User/Host               | Up to 32 users. 3 user levels: administrator, common user and operator  |
| Client                  | Uniarch client, Uniarch Care  |
| Web Browser             | Plug-in required live view: IE 10+, Chrome 45+, Firefox 52+, Edge 79+, Plug-in free live view: Chrome 57.0 and above, Firefox 58.0 and above, Edge 16 and above |
| <b>Interface</b>        |   |
| Audio I/O               | N/A   |
| Alarm I/O               | N/A   |
| Built-in Mic            | Support   |
| Built-in Speaker        | N/A   |
| WIFI                    | N/A   |
| Network                 | 1 × RJ45 10 M/100 M Base-TX Ethernet  |
| Video Output            | N/A   |
| <b>Certification</b>    |   |
| EMC                     | CE-EMC (EN 55032, EN 61000-3-3, EN IEC 61000-3-2, EN 55035)<br>FCC (FCC 47 CFR part15 B)  |
| Safety                  | CE-LVD (EN 62368-1)   |
| Environment             | CE-RoHS (2011/65/EU ; (EU) 2015/863) ; WEEE (2012/19/EU)  |

|                     |   |
|---------------------|---|
| Protection          | IP67 (IEC 60529)<br>IK10 (IEC 62262)                                    |
| <b>General</b>      |   |
| Power               | DC 12 V±25%, PoE (IEEE 802.3af)<br>Power consumption: Max. 8.0 W        |
| Power Interface     | Ø5.5 mm coaxial power plug  |
| Dimensions          | Ø128 mm × 100 mm (Ø5.0" × 3.9") (Ø × H)                                 |
| Weight              | 0.66 kg (1.46 lb.)  |
| Material            | Metal + Plastic   |
| Storage Environment | -30 °C to 60 °C (-22 °F to 140 °F), Humidity: ≤ 95% RH (non-condensing) |
| Working Environment | -30 °C to 60 °C (-22 °F to 140 °F), Humidity: ≤ 95% RH (non-condensing) |
| Surge Protection    | 4 KV  |
| Reset Button        | Support   |

## Dimensions



## Accessories

|  |  |  |
|--|--|--|
| <p><b>TR-JB03-H-IN-V2</b><br/>Junction Box for Metal Turret Camera(Support wiring from behind)</p>                 | <p><b>TR-JB07/WM03-F-IN-V2</b><br/>Wall Mounting Assembling Bracket with Back Hole for 3 Inch Hemisphere</p> | <p><b>TR-WM03-B-IN-V2</b><br/>Wall Mounting Assembling Bracket for 3 Inch Hemisphere</p> |
|                                   |                             |       |
| <p><b>TR-A01-IN</b><br/>NPT 3/4" Waterproof Cable Gland</p>  | <p><b>HS-207S</b><br/>Sunshade Shell for Zoom Dome</p>   | <p><b>TR-UP06-C-IN-V2</b><br/>Pole Mounting Bracket for Bullet Junction Box Only</p>     |
|  |                             |       |
| <p><b>TR-UC08-C-V2</b><br/>Bullet&amp;Dome Corner Mounting Bracket</p>   | <p><b>TR-CM24-IN</b><br/>Dome Pendant Mounting Bracket(Indoor)</p>   | <p><b>TR-SE24-A-IN</b><br/>Dome Pendant Mounting Pole 500mm</p>                          |
|                                 |                           |     |
| <p><b>TR-SE24-IN</b><br/>Dome Pendant Mounting Pole 200mm</p>  |  |  |
|                                 |  |  |

### Zhejiang Uniview Technologies Co., Ltd.



<http://www.uniview.com>



[overseasbusiness@uniview.com](mailto:overseasbusiness@uniview.com); [globalsupport@uniview.com](mailto:globalsupport@uniview.com)



No. 369, Xietong Road, Xixing Sub-district, Binjiang District, Hangzhou City, 310051, Zhejiang Province, China



©2023-2025 Zhejiang Uniview Technologies Co., Ltd. All rights reserved.

\*Product specifications and availability are subject to change without notice.

\*Despite our best efforts, technical or typographical errors may exist in this document.

Uniview cannot be held responsible for any such errors and reserves the right to change the contents of this document without prior notice.