

5MP HD IR VF Dome Network Camera IPC3635SR4-ADZK-H

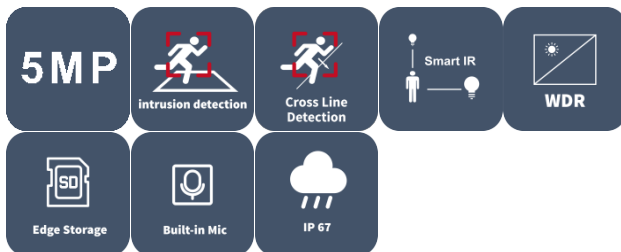

Features

- High quality image with 5 MP, 1/2.7" CMOS sensor
- 5 MP (2880 × 1620)@25/20 fps; 4 MP (2560 × 1440)@25/20 fps; 3 MP (2304 × 1296)@30/25 fps; 1080P (1920 × 1080)@30/25 fps
- Ultra 265, H.265, H.264, MJPEG
- 120 dB true WDR technology enables clear image in strong light scene
- Supports 9:16 corridor mode
- Smart IR, up to 40 m (131.2 ft.) IR distance
- MicroSD, up to 256 GB
- IP67 protection
- Supports PoE power supply
- 3-axis

Specifications

Model	IPC3635SR4-ADZK-H
BOM	
BOM	0235U69L
Camera	
Max Resolution	5 MP
Sensor	1/2.7" CMOS
Min. Illumination	Color: 0.001 Lux (F1.6, AGC ON), 0 Lux with IR
Day/Night	IR-cut filter with auto switch (ICR)
Shutter	Auto/Manual, 1 ~ 1/100000s
Adjustment Angle	Pan: 0° to 360°, Tilt: 0° to 75°, Rotate: 0° to 360°
S/N	>52 dB
WDR	120 dB
Lens	
Focal Length	2.8 to 12 mm
Iris Type	Fixed
Iris	F1.6
Field of View (H)	96.4° to 32.7°
Field of View (V)	51.3° to 18.6°
Field of View (D)	101.2° to 37.2°
DORI	
DORI Distance (Lens)	2.8 to 12 mm
DORI Distance (Detect)	63.0 m to 270.0 m (206.7 ft. to 885.8 ft.)
DORI Distance (Observe)	25.2 m to 108.0 m (82.7 ft. to 354.3 ft.)
DORI Distance (Recognize)	12.6 m to 54.0 m (41.3 ft. to 177.2 ft.)
DORI Distance (Identify)	6.3 m to 27.0 m (20.7 ft. to 88.6 ft.)
Illuminator	
Supplemental Light	IR
Illumination Distance (IR)	40 m (131.2 ft.)
Wavelength	850 nm
IR On/Off Control	Auto/Manual
Video	
Video Compression	Ultra 265, H.265, H.264, MJPEG
H.264 Code Profile	Baseline profile, Main profile, High profile
Frame Rate	Main Stream: 5 MP (2880 × 1620), max. 25 fps; 4 MP (2560 × 1440), max. 25 fps; 3 MP (2304 × 1296), max. 30 fps; 1080P (1920 × 1080), max. 30 fps; Sub Stream: 720P (1280 × 720), max. 30 fps; D1 (720 × 576), max. 30 fps; 640 × 360, max. 30 fps;
Video Bit Rate	128 Kbps to 6144 Kbps
U-code	Support
OSD	Up to 4 OSDs
Privacy Mask	Up to 4 areas
ROI	Support

Video Stream	Dual streams
Image	
White Balance	Auto, Outdoor, Fine tune, Sodium lamp, Locked, Auto2
Digital Noise Reduction	2D/3D DNR
Smart IR	Support
Flip	Normal, Flip vertical, Flip horizontal, 180°, 90° Clockwise, 90° Anti-clockwise
Dewarping	N/A
HLC	Support
BLC	Support
Defog	Digital defog
Events	
Basic Detection	Motion detection, Ultra motion detection, Tampering alarm, Audio detection, Cross line (based on human body detection), Intrusion (based on human body detection)
General Function	Watermark, IP address filtering, Access policy, ARP protection, RTSP authentication, User authentication, HTTP authentication
Audio	
Audio Compression	G.711U, G.711A
Audio Bitrate	64 Kbps
Two-way Audio	N/A
Suppression	Support
Sampling Rate	8 kHz
Storage	
Edge Storage	MicroSD, up to 512 GB
Network Storage	ANR, NAS (NFS)
Network	
Protocols	IPv4, IGMP, ICMP, ARP, TCP, UDP, DHCP, RTP, RTSP, RTCP, RTMP, DNS, DDNS, NTP, FTP, UPnP, HTTP, HTTPS, SMTP, SSL/TLS, QoS, SNMP
Compatible Integration	ONVIF (Profile S, Profile G, Profile T), API, SDK
User/Host	Up to 32 users, 2 user levels: administrator and common user
Security	Password Protection, Strong Password, HTTPS Encryption, Export Operation Logs, Basic and Digest Authentication for RTSP, Digest Authentication for HTTP, TLS 1.2, WSSE and Digest Authentication for ONVIF
Client	UNV-Link, UNV-Link Pro, EZStation
Web Browser	Plug-in required live view: IE 10+, Chrome 45+, Firefox 52+, Edge 79+, Plug-in free live view: Chrome 57+, Firefox 58+, Edge 16+
Interface	
Audio I/O	N/A
Alarm I/O	N/A
Serial Port	N/A
Built-in Mic	Support
Built-in Speaker	N/A
WIFI	N/A
Network	1 × RJ45 10 M/100 M Base-TX Ethernet





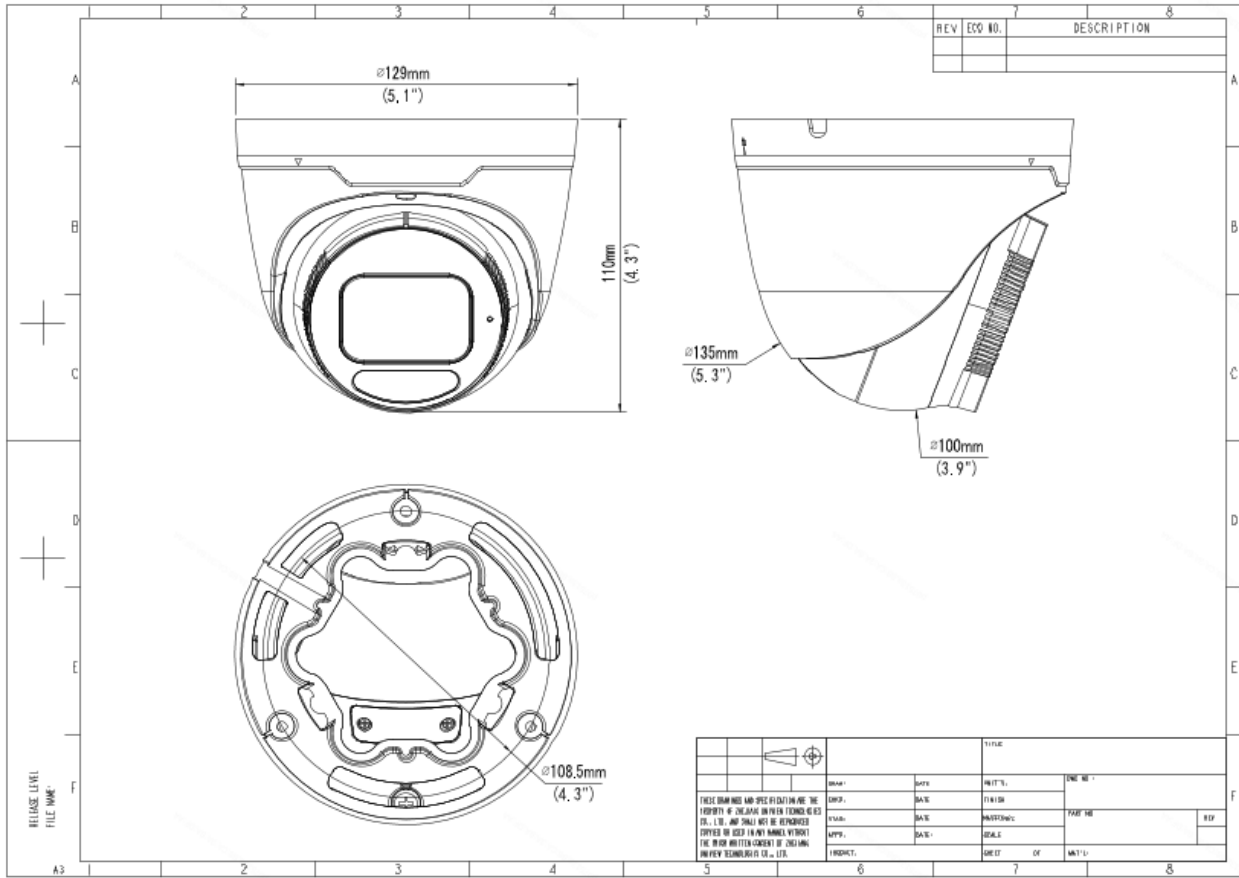



Video Output	N/A
Certification	
EMC	CE-EMC (EN 55032, EN 61000-3-3, EN IEC 61000-3-2, EN 55035) FCC (FCC 47 CFR part15 B)
Safety	CE LVD (EN 62368-1) CB (IEC 62368-1) UL/CUL (UL 62368-1, CAN/CSA C22.2 No. 62368-1)
Environment	CE-RoHS (2011/65/EU;(EU)2015/863); WEEE (2012/19/EU);
Protection	IP67 (IEC 60529)
General	
Power	DC 12 V±25%, PoE (IEEE 802.3af)
Power Consumption	Max. 7.5 W
Power Interface	Ø5.5 mm coaxial power plug
Dimensions	Ø129 mm × 110 mm (Ø5.1" × 4.3") (Ø × H)
Weight	0.66 kg (1.46 lb.)
Material	Metal
Working Environment	-30 °C to 60 °C (-22 °F to 140 °F), Humidity: ≤ 95% RH (non-condensing)
Storage Environment	-30 °C to 60 °C (-22 °F to 140 °F), Humidity: ≤ 95% RH (non-condensing)
Surge Protection	6 KV
Reset Button	Support
Web Client Language	4 Languages: English, Russian, Spanish, Vietnamese

Dimensions



Accessories

TR-JB03-H-IN Junction Box for Metal Turret Camera(Support wiring from behind)	TR-JB03-H-IN-V2 Junction Box for Metal Turret Camera(Support wiring from behind)	TR-JB07/WM03-F-IN Wall Mounting Assembling Bracket with Back Hole for 3 Inch Hemisphere
TR-WM03-B-IN Wall Mounting Assembling Bracket for 3 Inch Hemisphere	TR-A01-IN NPT 3/4" Waterproof Cable Gland	TR-UP06-IN Universal Pole Mounting Bracket

<p>TR-UC08-C Bullet&Dome Corner Mounting Bracket</p> 	<p>TR-SE24-IN Dome Pendent Mounting Pole 200mm</p> 	<p>TR-SE24-A-IN Dome Pendent Mounting Pole 500mm</p> 
<p>TR-CM24-IN Dome Pendent Mounting Bracket(Indoor)</p> 	<p>TR-JB07/WM03-F-IN-V2 Wall Mounting Assembling Bracket with Back Hole for 3 Inch Hemisphere</p> 	<p>TR-WM03-B-IN-V2 Wall Mounting Assembling Bracket for 3 Inch Hemisphere</p> 
<p>TR-UP06-C-IN-V2 Pole Mounting Bracket for Bullet Junction Box Only</p> 	<p>TR-UC08-C-V2 Bullet&Dome Corner Mounting Bracket</p> 	

Unlimited New View

Zhejiang Uniview Technologies Co., Ltd.



<http://www.uniview.com>



overseasbusiness@uniview.com; globalsupport@uniview.com



No. 369, Xietong Road, Xixing Sub-district, Binjiang District, Hangzhou City, 310051, Zhejiang Province, China



©2023-2025 Zhejiang Uniview Technologies Co., Ltd. All rights reserved.

*Product specifications and availability are subject to change without notice.

Despite our best efforts, technical or typographical errors may exist in this document. Uniview cannot be held responsible for any such errors and reserves the right to change the contents of this document without prior notice.