

Intelligent Integrated Management BOX Quick Guide

V2.01

Preface

The content of this section is designed to ensure that users use the product correctly to prevent dangers or property loss caused by improper operation. Before using this product, be sure to read this manual carefully. Please keep this manual properly for future reference.

About This Manual

- We recommend that you use this manual under the guidance of a professional.
- This manual is designed for use with multiple product models, and it is not possible to list the appearance and functions of each product individually. Please refer to the actual product for use.
- This manual is intended for multiple software versions, and the illustrations and descriptions in this manual may be different from the actual GUI and functions of the software.
- Despite our best efforts, technical or typographical errors may exist in this manual. Uniview cannot be held responsible for any such errors and reserves the right to change the manual without prior notice.
- Users are fully responsible for the damages and losses that arise due to improper operation.
- Uniview reserves the right to change any information in this manual without any prior notice or indication. Due to such reasons as product version upgrade or regulatory requirement of relevant regions, this manual will be periodically updated.
- This manual will be updated in real time according to the laws and regulations of the relevant regions. For specific details, please refer to the product's paper copy, QR code, or official website. In case of any discrepancy between the paper copy and the electronic version, the electronic version shall prevail.

About This Product

If the product you have chosen is a video product, please strictly adhere to the applicable laws and regulations. You can visit our official website to inquire about the relevant content.

Instructions for Use

- This document serves as a guide for use only. All statements, information, and suggestions contained in this document do not constitute any express or implied warranty.
- We assume no responsibility for any special, incidental, consequential, or indirect damages resulting from the use of this manual or the use of our products, including but not limited to losses due to loss of business profits, data or document loss, and product malfunction or information leakage caused by cyber-attack, hacker attack, and virus infections.
- Due to uncertain factors such as the physical environment, there may be discrepancies between the actual values of some data and the reference values provided in the manual. In case of any questions or disputes, the company's final interpretation shall prevail.



Formatting Conventions

The UI formatting conventions used in this document are as follows:

Format	Meaning
Bold	Bold means UI elements (button names, menu names, window names, etc.), e.g., Click Save .
>	Indicate a sequence of actions, e.g., click Device Management > Add Device, which means first click Device Management, and then click Add Device.

Symbol Conventions

This document uses various distinctive symbols to highlight areas that require special attention during the operation process. The meanings of these symbols are as follows:

Symbol	Meaning
	NOTE: Provides tips and additional information related to the operation and use of the product.
	CAUTION: Alerts to matters that requires attention during operation, as improper handling may lead to product damage, data loss, or functional abnormalities.
	WARNING: The annotations following this symbol demand extra attention, as improper handling could potentially cause personal injury.

Legal Statement

Copyright Statement

©2025-2026 Zhejiang Uniview Technologies., Co., Ltd. All rights reserved.

All parts of this document, including but not limited to text, images, and graphics, are copyrighted and belong to Zhejiang Uniview Technologies Co., Ltd (hereinafter referred to as "Uniview" "we" "us"). Without our written permission, no organization or individual may excerpt, copy, translate, modify, or disseminate any part or all of the content of this manual in any form. The products described in this manual may contain software copyrighted by us and any potential licensors. Without the permission of the relevant rights holders, no one may copy, distribute, modify, excerpt, decompile, disassemble, decrypt, reverse engineer, rent, transfer, sublicense, or engage in any other actions that infringe upon the software copyright in any form.

Trademark Acknowledgements

 are trademarks or registered trademarks of Uniview.



The terms HDMI, HDMI High-Definition Multimedia Interface, HDMI Trade dress and the HDMI Logos are trademarks or registered trademarks of HDMI Licensing Administrator, Inc.

All other trademarks, products, services and companies in this manual or the product described in this manual are the property of their respective owners.

Export Compliance Statement

Uniview complies with applicable export control laws and regulations worldwide, including that of the People's Republic of China and the United States, and abides by relevant regulations relating to the export, re-export and transfer of hardware, software and technology. Regarding the product described in this manual, Uniview asks you to fully understand and strictly abide by the applicable export laws and regulations worldwide.

EU Authorised Representative

UNV Technology EUROPE B.V. Treubstraat 1, 2288 EG, Rijswijk, Netherlands.
If you have any feedback, please contact us at service@uniview.com.

Disclaimer of Liability

- We assume no responsibility and offer no compensation for any special, incidental, consequential, or indirect damages resulting from the use of this manual or our products, including but not limited to losses related to lost business profits, data, or document loss.
- The product described in this manual is provided on an "as is" basis. Unless required by applicable law, this manual is only for informational purpose, and all statements, information, and recommendations in this manual are presented without warranty of any kind, expressed or implied, including, but not limited to, merchantability, satisfaction with quality, fitness for a particular purpose, and noninfringement.
- Users must assume total responsibility and all risks for connecting the product to the Internet, including, but not limited to, network attack, hacking, and virus. Uniview strongly recommends that users take all necessary measures to enhance the protection of network, device, data and personal information. Uniview disclaims any liability related thereto but will readily provide necessary security related support.
- To the extent not prohibited by applicable law, in no event will Uniview and its employees, licensors, subsidiary, affiliates be liable for results arising out of using or inability to use the product or service, including, not limited to, loss of profits and any other commercial damages or losses, loss of data, procurement of substitute goods or services; property damage, personal injury, business interruption, loss of business information, or any special, direct, indirect, incidental, consequential, pecuniary, coverage, exemplary, subsidiary losses, however caused and on any theory of liability, whether in contract, strict liability or tort (including negligence or otherwise) in any way out of the use of the product, even if Uniview has been advised of the possibility of such damages (other than as may be required by applicable law in cases involving personal injury, incidental or subsidiary damage).
- To the extent allowed by applicable law, in no event shall Uniview's total liability to you for all damages for the product described in this manual (other than as may be required by applicable law in cases involving personal injury) exceed the amount of money that you have paid for the product.

- When using this product, please strictly adhere to the applicable laws and regulations to avoid infringing upon the rights of third parties, including but not limited to intellectual property rights, data rights, or other privacy rights. You must also not use this product for the purposes of developing or facilitating the use of weapons of mass destruction, biological or chemical weapons, nuclear weapons, or for any other purposes that violate international norms and regulations.

Privacy Protection Reminder

Uniview complies with appropriate privacy protection laws and is committed to protecting user privacy. You may want to read our full privacy policy at our website and get to know the ways we process your personal information. Please be aware, using the product described in this manual may involve the collection of personal information such as face, fingerprint, license plate number, email, phone number, GPS. Please abide by your local laws and regulations while using the product.

Safety Precautions

The device must be installed, serviced and maintained by a trained professional with necessary safety knowledge and skills. Before you start using the device, please read through this guide carefully and make sure all applicable requirements are met to avoid danger and loss of property.

Storage, Transportation, and Use

- Store or use the device in a proper environment that meets environmental requirements, including and not limited to, temperature, humidity, dust, corrosive gases, electromagnetic radiation, etc.
- Make sure the device is securely installed or placed on a flat surface to prevent falling.
- Unless otherwise specified, do not stack devices.
- Ensure good ventilation in the operating environment. Do not cover the vents on the device. Allow adequate space for ventilation.
- Protect the device from liquid of any kind.
- Make sure the power supply provides a stable voltage that meets the power requirements of the device. Make sure the power supply's output power exceeds the total maximum power of all the connected devices.
- Verify that the device is properly installed before connecting it to power.
- Do not remove the seal from the device body without consulting Uniview first. Do not attempt to service the product yourself. Contact a trained professional for maintenance.
- Always disconnect the device from power before attempting to move the device.
- Take proper waterproof measures in accordance with requirements before using the device outdoors.

Power Requirements

- Install and use the device in strict accordance with your local electrical safety regulations.
- Use a UL certified power supply that meets LPS requirements if an adapter is used.

- Use the recommended cordset (power cord) in accordance with the specified ratings.
- Only use the power adapter supplied with your device.
- Use a mains socket outlet with a protective earthing (grounding) connection.
- Ground your device properly if the device is intended to be grounded.

Battery Safety

Please use batteries properly; otherwise, there is a risk of fire or explosion.

- **Warning:** Using incorrect battery models can lead to explosion.
- If you need to replace the battery, it is recommended that you go to an authorized service center or have it replaced under professional supervision. We shall not be held responsible for any issues arising from unauthorized battery replacement.
- When replacing the battery, be sure to use a battery of the same type as the original! Using the wrong model for replacement (such as certain types of lithium batteries) may cause safety protection to fail.
- Batteries must not be exposed to overheat environments such as sunlight, fire, as this may lead to fire, explosion, or combustion.
- Do not dispose of batteries in fire or heating appliances. Do not squeeze, bend, or cut batteries, as it may cause explosion.
- Do not expose batteries to extremely high or low temperatures, or to very low-pressure environments, as this may cause explosion or leakage of flammable liquid/gas.
- Dispose of the used battery according to your local regulations or the battery manufacturer's instructions.
- For products or the included remote control containing a button cell battery: Do not ingest the battery - chemical burn hazard! If swallowed, a button cell battery can cause severe internal burns within 2 hours and may be fatal. Precautions (including but not limited to):
 - Keep new and used batteries away from children.
 - Stop using the product and keep it away from children if the battery compartment is not securely closed.
 - If you suspect that a battery may have been swallowed or inserted inside any part of the body, seek immediate medical attention.

Network Security

Please take all necessary measures to enhance network security for your device.

The following are necessary measures for the network security of your device:

- **Change default password and set strong password:** You are strongly recommended to change the default password after your first login and set a strong password of at least nine characters including all three elements: digits, letters and special characters.
 - Do not include the account name or the reverse of the account name.
 - Avoid using consecutive characters, such as 123, abc, etc.
 - Do not use overlapping characters, such as 111, aaa, etc.
- **Keep firmware up to date:** It is recommended that your device is always upgraded to the latest version for the latest functions and better security. Visit Uniview's official website or contact your local dealer for the latest firmware.

The following are recommendations for enhancing network security of your device:

- **Change password regularly:** Change your device password on a regular basis and keep the password safe. Make sure only the authorized user can log in to the device.
- **Enable HTTPS/SSL:** Use SSL certificate to encrypt HTTP communications and ensure data security.
- **Enable IP address filtering:** Allow access only from the specified IP addresses.
- **Minimum port mapping:** Configure your router or firewall to open a minimum set of ports to the WAN and keep only the necessary port mappings. Never set the device as the DMZ host or configure a full cone NAT.
- **Disable the automatic login and save password features:** If multiple users have access to your computer, it is recommended that you disable these features to prevent unauthorized access.
- **Choose username and password discretely:** Avoid using the username and password of your social media, bank, email account, etc, as the username and password of your device, in case your social media, bank and email account information is leaked.
- **Restrict user permissions:** If more than one user needs access to your system, make sure each user is granted only the necessary permissions.
- **Disable UPnP:** When UPnP is enabled, the router will automatically map internal ports, and the system will automatically forward port data, which results in the risks of data leakage. Therefore, it is recommended to disable UPnP if HTTP and TCP port mapping have been enabled manually on your router.
- **SNMP:** Disable SNMP if you do not use it. If you do use it, then SNMPv3 is recommended.
- **Multicast:** Multicast is intended to transmit video to multiple devices. If you do not use this function, it is recommended you disable multicast on your network.
- **Check logs:** Check your device logs regularly to detect unauthorized access or abnormal operations.
- **Physical protection:** Keep the device in a locked room or cabinet to prevent unauthorized physical access.
- **Isolate video surveillance network:** Isolating your video surveillance network with other service networks helps prevent unauthorized access to devices in your security system from other service networks.

Learn More

You may also obtain security information under Security Response Center at Uniview's official website.

Avertissement de l'utilisation de la batterie

- Lorsque utiliser la batterie, évitez:
 - Température et pression d'air extrêmement élevées ou basses pendant l'utilisation, le stockage et le transport.
 - Remplacement de la batterie.
- Utilisez la batterie correctement. Mauvaise utilisation de la batterie comme celles mentionnées ici, peut entraîner des risques d'incendie, d'explosion ou de fuite liquide de gaz inflammables.
 - Remplacer la batterie par un type incorrect.
 - Disposer d'une batterie dans le feu ou un four chaud, écraser mécaniquement ou couper la batterie.

- Disposer la batterie utilisée conformément à vos règlements locaux ou aux instructions du fabricant de la batterie.

Regulatory Compliance

FCC Statements

This device complies with Part 15 of the FCC Rules. Operation is subject to the following two conditions: (1) this device may not cause harmful interference, and (2) this device must accept any interference received, including interference that may cause undesired operation.

Visit https://global.uniview.com/Support/Download_Center/Product_Installation/Declaration/ for SDoC.

Caution: The user is cautioned that changes or modifications not expressly approved by the party responsible for compliance could void the user's authority to operate the equipment.

NOTE: This equipment has been tested and found to comply with the limits for a Class A digital device, pursuant to part 15 of the FCC Rules. These limits are designed to provide reasonable protection against harmful interference when the equipment is operated in a commercial environment. This equipment generates, uses, and can radiate radio frequency energy and, if not installed and used in accordance with the instruction manual, may cause harmful interference to radio communications. Operation of this equipment in a residential area is likely to cause harmful interference in which case the user will be required to correct the interference at his own expense.

LVD/EMC Directive



This product complies with the European Low Voltage Directive 2014/35/EU and EMC Directive 2014/30/EU.

WEEE Directive-2012/19/EU



The product this manual refers to is covered by the Waste Electrical & Electronic Equipment (WEEE) Directive and must be disposed of in a responsible manner.

Battery Regulation- (EU) 2023/1542



Battery in the product complies with the European Battery Regulation (EU) 2023/1542. For proper recycling, return the battery to your supplier or to a designated collection point.

1 Packing List

The package contents may vary with box model and version.

No.	Name	Qty	Unit
1	Intelligent Integrated Management BOX (referred to as box hereafter)	1	PCS
2	Box door key	2	PCS
3	Box prefixing bracket (with 2 clamps)	1	Set
4	Clamp	2	PCS
5	Waterproof components	5	Set
6	Warning light	1	PCS
7	M4-10mm cross screw	16	PCS
8	M4-20mm cross screw	16	PCS
9	M3-8mm Phillips screwdriver	4	PCS
10	Hex key	1	PCS
11	M8-10mm hex socket screw	4	PCS
12	M8-20mm hex socket screw	4	PCS
13	Intelligent cloud management server mechanical hard disk drive installation accessories	1	Set
14	Intelligent cloud management server SSD installation accessories	1	Set
15	Product documents	1	Set

2 Product Overview

The box is an all-in-one solution that integrates power supply, networking, device management, remote maintenance, smart video management, and more. It features high integration, high reliability, ease of maintenance, and simple installation, suitable for construction sites, highways, farms, cities, industrial parks, etc. The box offers AC and DC models for scenarios with or without access to power, installing a 4G router (user-provided) can enable use in wireless network environments.

2.1 Dimensions

The figures below are for illustrative purposes only.

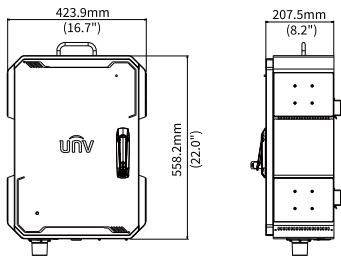

2.2 Structure

Normally, you only need to operate the first layer of the box. See [Door Lock Operation](#) for the steps to open the box door. The second layer is accessible for maintenance by opening the sheet metal. The actual structure may vary depending on the model.



NOTE!

- The internal wiring is completed before delivery
 - Do not attempt to open the device. If the product has any issues, please return it to the factory for repair
 - A rated 20A circuit breaker which complied with UL489 shall be provided during final installation
-

2.2.1 AC Model

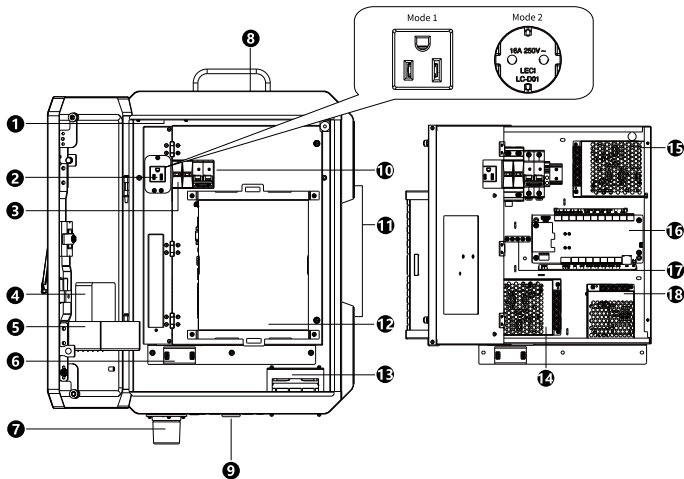

No.	Name	No.	Name
1	Fan	2	Socket <ul style="list-style-type: none"> ● Model 1 Output voltage: AC120V Rated current: 6A ● Model 2 Output voltage: AC230V Rated current: 6A <p>Note: Different regions require different models. Please choose the intelligent integrated management box according to your local electrical standards.</p>

No.	Name	No.	Name
3	Circuit breaker	4	4G router (with at least 2 LAN ports reserved) Note: The 4G router is user-provided. Please place it here when the installation is completed.
5	Network device slot	6	Mains wiring terminal
7	Warning light	8	IP speaker installation hole
9	Dome camera mounting plate/IP speaker installation hole	10	Surge protector
11	Camera junction box mounting hole	12	Intelligent cloud management server (referred to as server hereafter)
13	Heater	14	Power supply for the server
15	Heater power supply	16	Power management module
17	Grounding terminal	18	Power management module, 12V input

2.2.2 DC Model

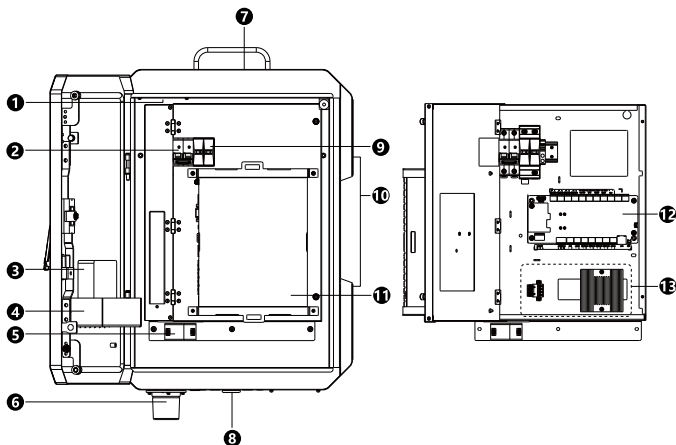

No.	Name	No.	Name
①	Fan	②	Circuit breaker
③	4G router (with at least 3 LAN ports reserved) Note: The 4G router is user-provided. Please place it here when the installation is completed.	④	Network device slot
⑤	DC input wiring terminal	⑥	Warning light
⑦	IP speaker installation hole	⑧	Dome camera mounting plate/IP speaker installation hole
⑨	Surge protector	⑩	Camera junction box mounting hole
⑪	Intelligent cloud management server (referred to as server hereafter)	⑫	Power management module
⑬	Power supply for the server	-	-

2.2.3 Intelligent Cloud Management Server

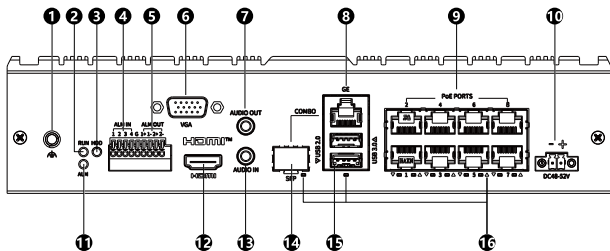

No.	Name	No.	Name
①	Grounding terminal	②	Operation indicator
③	Hard disk indicator	④	Alarm input interface
⑤	Alarm output interface	⑥	VGA interface
⑦	Audio output interface	⑧	Server network interface
⑨	PoE ports	⑩	Power interface
⑪	Alarm indicator	⑫	HDMI interface
⑬	Audio input interface	⑭	Optical interface
⑮	USB interface	⑯	Network interface indicator

Indicator	Status	Description
RUN	Blinking	The device is starting up
	On	The device runs normally
	Off	The device is powered off
HDD	Blinking	Reading or writing data
	On	No hard disk; or disk is abnormal
	Off	The device is powered off
ALM	On	Device alarm occurred
	Off	No alarm
Network interface	On	Connected to network
	Blinking	Data communication is ongoing
	Off	Disconnected from network

3 Device Installation

3.1 Installation Tools

The following tools will be required during the installation.

- ESD gloves
- Screwdriver

3.2 Lightning Protection

Lightning protection measures must be place when the device is installed at a high place.

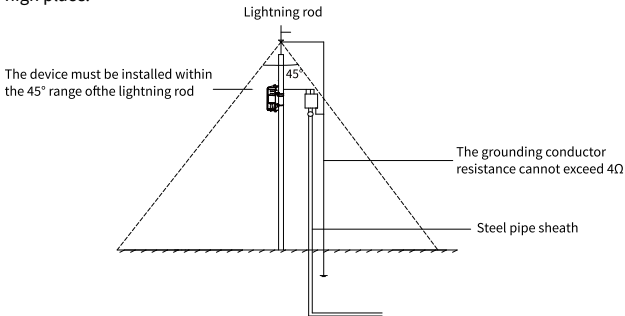

- The device should be installed within the effective range of the lightning rod.
- Outdoor wiring should preferably be routed along the eaves.
- In open areas, sealed steel pipes must be buried for wiring and grounded at a single point. Suspended wiring is strictly prohibited.
- In the case of outdoor installation, please take the necessary protective measures to ensure electrical safety, and install surge protectors as required.
- In areas with severe thunderstorms or high induced voltages (for example, high voltage substations), additional protection devices must be installed, such as high-power lightning protection device, lightning conductor, etc.
- The lightning protection and grounding for outdoor installations and lines must be designed in accordance with the lightning protection requirements of the buildings and must comply with the relevant national and industry standards.
- The system must be connected to a common electrical potential ground. The grounding equipment must meet both the requirements for system interference resistance and electrical safety and must not be short-circuited or mixed with the neutral line of the high-voltage power grid. When the system is grounded separately, the grounding impedance must not exceed 4Ω , and the cross-sectional area of the grounding conductor must be equal to or greater than 25mm^2 .

3.3 Installation



CAUTION!

- To prevent the network device from falling, do not place it inside the box before installation is complete.
- A clamp can hold a maximum weight of 20kg.

3.3.1 Door Lock Operation

1. If the box door is locked, insert the key from the package into the keyhole and rotate it 180° counterclockwise to unlock.

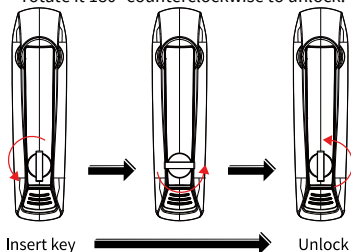

2. After unlocking, be sure to remove the key to prevent it from being accidentally ejected during subsequent operations.

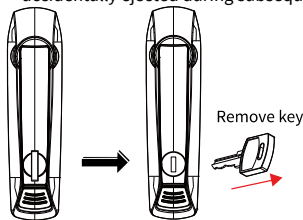

3. Press the switch at the bottom of the lock, then rotate the popped-out door handle 90° clockwise to open the door.

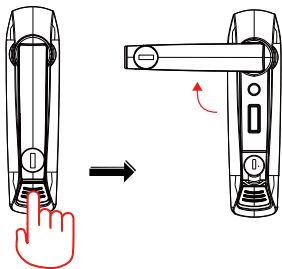
**NOTE!**

To close and lock the door, reverse the steps and keep the key safe.

3.3.2 (Optional) Hard Drive Installation

If the intelligent cloud management server did not come with a hard disk during purchase, you may choose to install a mechanical hard drive or solid-state drive (SSD) as needed. If installation is required, please provide your own hard drive. For detailed installation instructions, refer to the corresponding installation guide included with the hard drive accessories.

**NOTE!**

You can differentiate between hard drive installation accessories by the size of the mounting bracket: the bracket for mechanical hard drives is larger than that for SSDs."

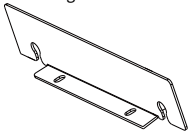

3.3.3 Warning Light Installation

1. Locate the warning light power cable inside the box at the indicated position. Pass the cable through the bottom warning light mounting hole and connect it to the 2-pin interface at the bottom of the warning light.

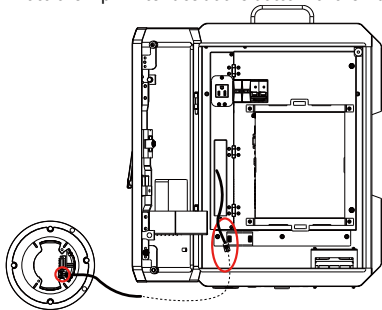

2. Align the silkscreen marks on the warning light with those on the bottom of the box, and secure it using the included M3 8mm cross screws.

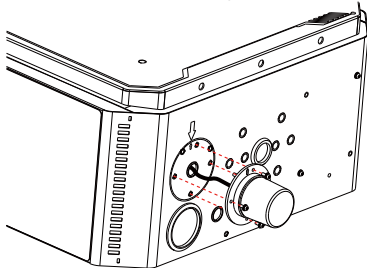

3.3.4 Device Installation

The camera, IP speaker, and junction box need to be purchased separately according to actual needs.



CAUTION!

Please use the (M8-20mm) hex socket screws  from the accessory kit to install the camera, and use the (M8-10mm) hex socket screws  to install the speaker.



NOTE!

- Only PoE-powered cameras are supported.
- It is recommended that the cameras installed on both sides of the box have similar weights.

Side mount

1. Check whether the hole diameter and hole spacing at the bottom of the junction box meet the requirements.

- Model 1 (suitable for fixed dome/turret network camera)

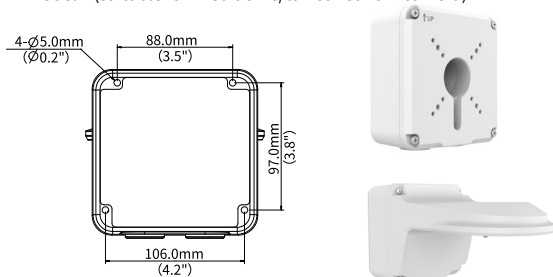

- Model 2 (suitable for bullet/dome network camera)

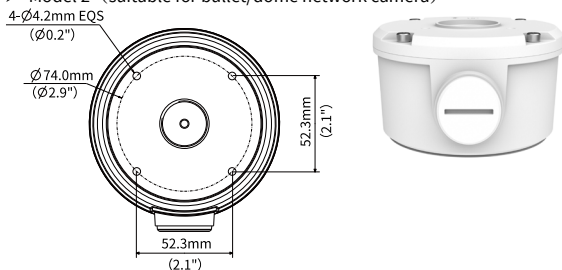

2. Remove the waterproof cover from the side of the box.

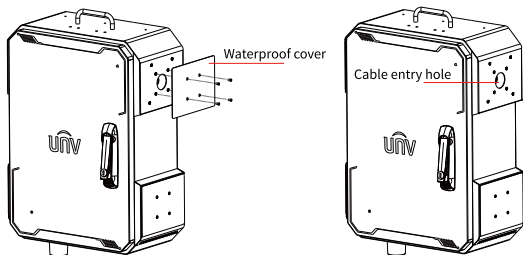

3. Install the camera, pass the network cable connected to the server through the cable entry hole, and connect it to the camera's tail cable. For camera installation details, please refer to the corresponding quick guide.

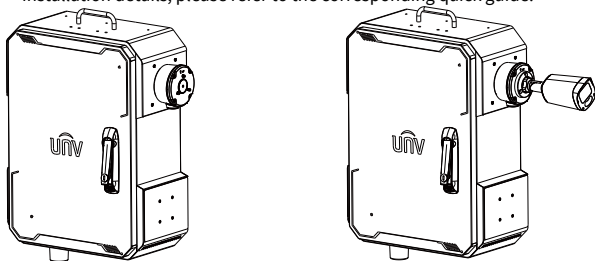

Bottom mount

1. Check whether the hole diameter and hole spacing of the dome camera mounting plate or the IP speaker bracket meets the requirements.

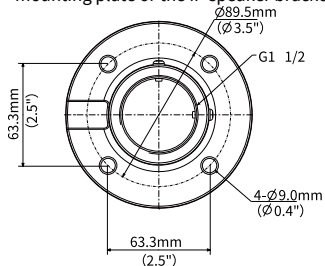

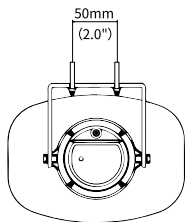

2. Find the installation holes for the cameras/IP speaker.

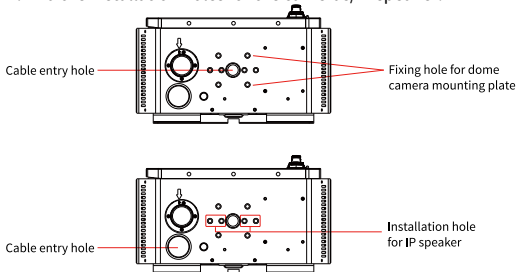

3. Install the camera/IP speaker, pass the network cable connected to the server through the cable entry hole, and connect it to the camera/IP speaker's tail cable. For camera/IP speaker installation details, please refer to the corresponding quick guide.

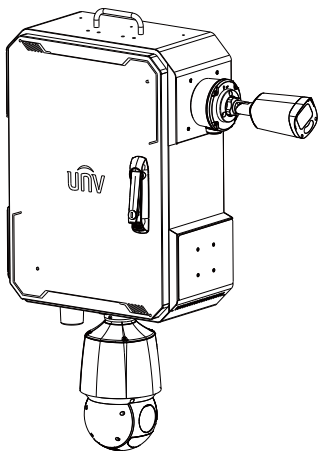

4. Use cable ties to secure the internal cables to the bottom of the box frame to prevent the device's tail cables from touching the heater.

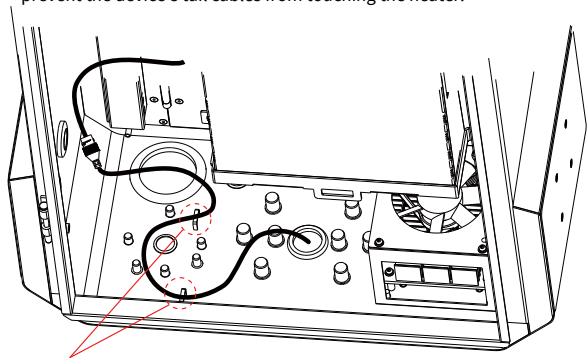

Use cable ties here

Top Installation

1. Only network speakers are supported for top installation, and the mounting bracket requirements are the same as those for bottom installation.
2. Find the corresponding mounting holes for installation. For network speakers installed on top, the tail cables should still enter the box through the wiring hole at the bottom. The internal wiring method is the same as for bottom installation.

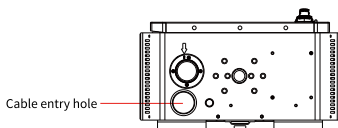
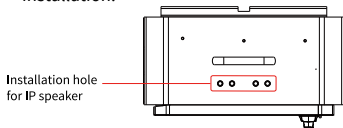

3.3.5 Box Installation

1. Secure the prefixing bracket to the pole using the clamp. The maximum supported pole diameter is 300mm.

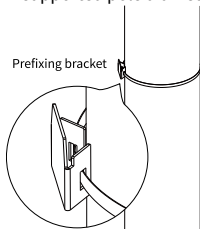

2. Insert the upper reinforcing element on the back of the box into the bracket to complete the prefixing.

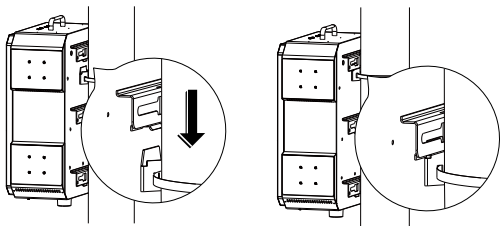

3. Use three clamps to secure the upper and lower reinforcing elements to complete the fixing.

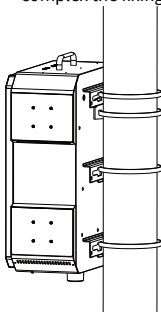

3.4 Network Connection

Choose the appropriate network connection method according to the local network environment.

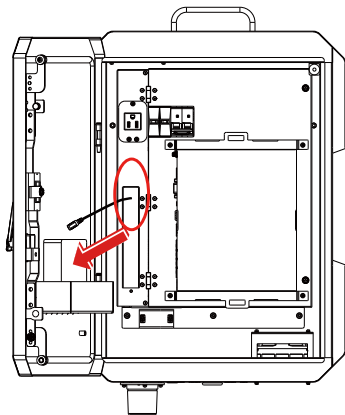
**CAUTION!**

The network devices mentioned in the following chapters must support a DC12V round-head power supply.

3.4.1 Wireless Network

1. Open the box door, place the 4G router (user-provided) in the compartment.
 - AC model: Please prepare a 4G router with at least 2 LAN ports reserved.
 - DC model: Please prepare a 4G router with at least 3 LAN ports reserved.

**CAUTION!**

The selected 4G router must meet the following requirements:

- The box provides 12V/2.5A, with a maximum power not exceeding 30W. The 4G router's power consumption should not exceed this limit.
- The router's bandwidth must meet the combined bandwidth requirements for the IPCs.

2. Connect the network cables from the server and the power management module to the 4G router.
3. Locate the cable tagged with ROUTER POWER, and connect it to the 4G router.

3.4.2 Wired Network

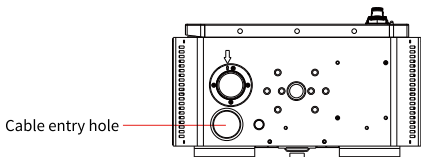

Connect External Fiber Optic Cable

1. Place the optical modem, optical transceiver, or optical-electrical switch into the box's network device slot.
 - AC model: Please prepare a network device with at least 2 electrical ports reserved.
 - DC model: Please prepare a network device with at least 3 electrical ports reserved.
2. Lead the external fiber optic cable through the cable entry hole at the bottom of the box, and connect it to the network device.
3. Connect network cables from the server and the power management module to the network device.
4. Locate the cable tagged with ROUTER POWER, and connect it to the network device.

Connect External Network Cable

1. Place the electrical switch into the box's network device slot.
 - AC model: Please prepare an electrical switch with at least 3 electrical ports reserved.
 - DC model: Please prepare an electrical switch with at least 4 electrical ports reserved.
2. Lead the external network cable through the cable entry hole at the bottom of the box, and connect it to the electrical switch.
3. Connect the network cables from the server and the power management module to the electrical switch.
4. Locate the cable tagged with ROUTER POWER, and connect it to the network device.

3.5 Power On



CAUTION!

- Do not operate with power connected. Before operating, ensure that the circuit breaker is in the OFF position, and all cables are de-energized.
- For the final installation, a UL 489-certified, 20-ampere circuit breaker must be installed at the front end.

3.5.1 AC Model

Connect the box to the mains supply.



CAUTION!

Voltage range for AC model: AC 100V to 240V.

1. Lead the mains supply cables through the cable entry hole. The terminals from left to right on the front panel of the box are Live, Neutral, Ground.
2. After ensuring correct connections, close the circuit breaker. All devices inside the box will be powered.

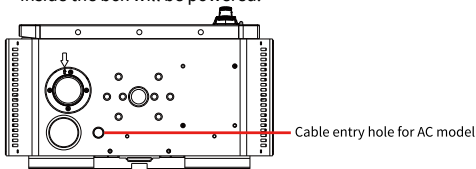

3.5.2 DC Model

Connects to the 12V solar power supply system. The following introduces how to connect the solar power supply system to the box. For precautions regarding the solar power supply system, see the corresponding quick guide.



CAUTION!

Voltage range for DC model: DC 10.8V to 14.4V.

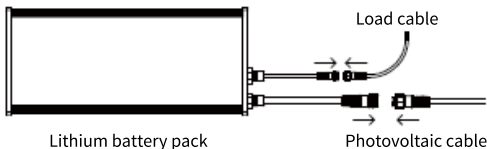

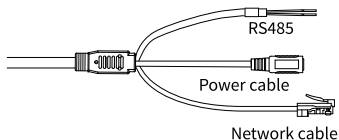

O&M module tail cables

1. Lead the solar cables through the cable entry hole at the bottom of the box.

Load Cable:

- Connect the aviation connector to the lithium battery pack's output port.
- Connect the RS485 terminal to the solar O&M module's RS485 cable.
- Connect the UT terminal to the DC box's input wiring terminal.

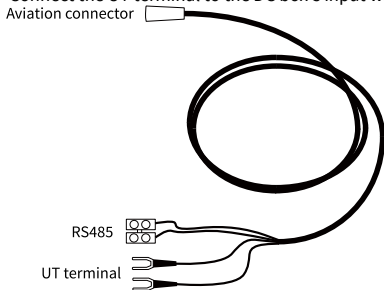

Adapter Cable:

- Connect the DC connector to the O&M module power supply.
- Connect the UT terminal to the DC box's input wiring terminal.

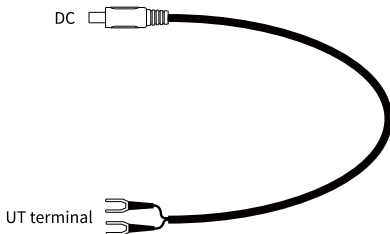

2. Crimp the UT terminal at the DC input wiring terminal, with Live, Neutral, and Ground arranged from left to right on the front panel of the box.
3. After ensuring correct connections, close the circuit breaker. All devices inside the box will be powered.

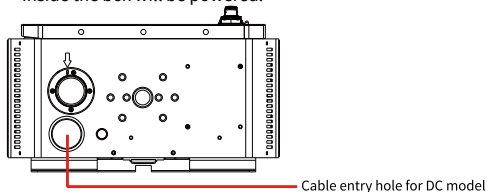

4 Local Web Management

4.1 Intelligent Cloud Management Server

4.1.1 Web Login

Default IP address

192.168.1.30

Default username/password

admin/123456

Note:

For security, please set a strong password (at least 9 characters, including uppercase and lowercase letters, digits, and special characters) after your first login. It is recommended to change the password regularly and store it securely to ensure that only authorized users can log in to the device.

4.1.2 Channel Management

PoE cameras have been added to the Intelligent Cloud Management Server through plug-and-play. To manage the added cameras and check their status ( means online), go to **Setup > Camera > Camera**.

Camera Fisheye Advanced

Auto Switch to H.265 On Off Note: Effective when first connected

Auto Switch to U-Code Off Note: Effective when first connected

Refresh Modify Delete Auto Search Search Segment Batch Edit Pass... Import

<input type="checkbox"/>	No.	Camera ID	Address	Port	Remote Camera ID	Protocol	Status
<input type="checkbox"/>	1	D1 (IP Camera 01)	173.16.0.1	80	1	Private	
<input type="checkbox"/>	2	D2 (IP Camera 02)	173.16.0.2	80	1	Private	
<input type="checkbox"/>	3	D3 (IP Camera 03)	173.16.0.3	80	1	Private	
<input type="checkbox"/>	4	D4 (IP Camera 04)	173.16.0.4	80	1	Private	
<input type="checkbox"/>	5	D5 (IP Camera 05)	173.16.0.5	80	1	Private	
<input type="checkbox"/>	6	D6 (IP Camera 06)	173.16.0.6	80	1	Private	
<input type="checkbox"/>	7	D7 (IP Camera 07)	173.16.0.7	80	1	Private	
<input type="checkbox"/>	8	D8 (IP Camera 08)	173.16.0.8	80	1	Private	

4.1.3 Recording Playback

On the **Playback** page, select the channel and date, and then click to start playback.

Live View
 Playback
 Setup
 Smart



NOTE!

- The system enables 24/7 scheduled recording for all channels by default. To adjust recording times and types, go to **Setup > Storage > Recording Schedule**.
- If you choose the event type of recording, you must first enable the corresponding event alarm and configure alarm-triggered recording.

4.2 Power Management Module

4.2.1 Web Login

Default IP address

192.168.1.13

Default username/password

admin/123456

Note:

For security, please set a strong password (at least 9 characters, including uppercase and lowercase letters, digits, and special characters) after your first login. It is recommended to change the password regularly and store it securely to ensure that only authorized users can log in to the device.

4.2.2 System Configuration

1 Language Configuration

Set the system language for the device. The default language is English.

System

Language Configuration

Threshold Configuration

Box Status and Po...

Network

Maintenance

Language Configuration

Device Language: English

Save

2 Threshold Configuration

Set temperature and humidity alarm thresholds. The following are system default values.

- Low temperature threshold: 41°F / 5°C
- High temperature threshold: 122°F / 50°C
- Humidity threshold: 95%

System

Language Configuration

Threshold Configuration

Box Status and Po...

Network

Maintenance

Threshold Configuration

Temperature Unit: Fahrenheit(°F) Celsius(°C)

Low temperature threshold: 41.0 °F

High temperature threshold: 122.0 °F

Humidity threshold: 95 %

Save

4.2.3 Distribution Box Status and Port Control

Manage the power status of the distribution box ports and perform intelligent control.

System

Box Status and Port Control

Box Status and Po...

Network

Maintenance

Output Port	Voltage Output Value	Voltage Status	Current Output Value	Current Status	On/Off	Intelligent Control	Operate
Socket	228.60V	Normal	0.00A	Normal	<input type="checkbox"/>		
SMSEVSE	228.60V	Normal	0.00A	Normal	<input type="checkbox"/>		
Heater	228.60V	Normal	0.00A	Normal	<input checked="" type="checkbox"/>	Auto Temperat... <input type="checkbox"/>	
Warning Light	0.11V	Normal	0.00A	Normal	<input type="checkbox"/>	Alarm Linkage <input checked="" type="checkbox"/>	
Network Device	0.11V	Normal	0.00A	Normal	<input type="checkbox"/>	Auto Disconnect... <input checked="" type="checkbox"/>	Refresh
Fan	0.11V	Normal	0.00A	Normal	<input type="checkbox"/>	Auto Temperat... <input checked="" type="checkbox"/>	

Box Environment

Temperature: 35.3°C Normal | Humidity: 14.00% Normal | Box Door Status: Closed | Fan: Off | Heater Status: On | Surge Protector Status: Normal | Input Voltage: 228.60V Normal

Total Current: 0.00A Normal | Leakage: No

- On/Off: Controls the enabling/disabling of the port.
- Auto Temperature Control: If enabled, the heater will automatically turn on when the temperature falls below the low temperature threshold, and the





fan will activate automatically when the temperature exceeds the high temperature threshold.

- Alarm Linkage: If enabled, the power management module will receive alarm output signals from the intelligent cloud management server. When the warning light is on, it will flash simultaneously if the intelligent cloud management server triggers an alarm output.
- Auto Disconnect Detection: Once enabled, the box will automatically monitor its connection status with EZCloud. If it fails to ping the server 4 consecutive times, it will restart the port (up to 5 attempts). After 5 failed attempts, it will stop trying to reconnect.
- Restart: Click to restart the router.

4.2.4 Network Configuration





1 Network

Use DHCP (default mode) to automatically assign an IP address.

 System	Network
 Box Status and Po...	Obtain IP Address <input type="text" value="DHCP"/>
 Network	IP Address <input type="text" value="192.168.3.202"/>
Network	IPv4 Subnet Mask <input type="text" value="255.255.255.0"/>
EZCloud	Default Gateway <input type="text" value="192.168.3.1"/>
 Maintenance	IPv6 Address <input type="text"/>
	Prefix Length <input type="text" value="64"/>
	IPv6 Default Gateway <input type="text"/>
	MAC Address <input type="text" value="00:53:26:14:24:58"/>
	<input type="button" value="Save"/>

2 EZCloud

Once the Intelligent Cloud Management Server is added in the app, the power management module is automatically added to cloud.

 System	EZCloud
 Box Status and Po...	EZCloud <input type="text" value="On"/>
 Network	Server IP <input type="text" value="wss-testap2.ezforview.com"/>
Network	Register Code <input type="text"/> <input type="button" value="Copy"/>
EZCloud	Device Status <input type="text" value="Online"/>
 Maintenance	Username <input type="text" value="wyap"/>
	Service Agreement <input type="text" value="http://wss-testap2.ezforview.com/doc/termsofservice.html"/>

4.2.5 System Maintenance

1 Device Status

View the basic information and operation status of the device.

System	Basic Info
Box Status and Po...	Basic Info
Network	Model
Maintenance	Serial No.
Basic Info	Hardware Version
Maintenance	Firmware Version
	Boot Version
	Status
	System Time
	Operation Time
	Refresh

2 System maintenance

Perform maintenance operations to the device.

System	Maintenance
Box Status and Po...	Restart Restart device
Network	Export Export configuration file
Maintenance	Export Export Diagnosis Info
Basic Info	Default <input type="checkbox"/> Restore all settings to defaults without keeping current network and user settings.
Maintenance	Importing <input type="text"/> Browse... Import
	Local Upgrade <input type="text"/> Browse... Upgrade <input type="checkbox"/> Upgrade Boot Program
	Note: The upgrade will take a while. Please do not disconnect power.





- Restart the device: Click **Restart**, then confirm to restart the device. The login page is displayed after the device completes restart.
- Export configurations: Click **Export** next to **Export configuration file** to export the current configuration information of the device.
- Export diagnosis information: Click **Export** next to **Export Diagnosis Info** to export the diagnosis information of the device.
- Restore defaults: Select **Restore all settings to defaults without keeping current network and user settings** (if needed) and then click **Default** to restore default settings.
- Import configurations: Click **Browse** next to the **Importing** field, locate the configuration file to import, and then click **Import** to apply the new configurations.
- Local upgrade: Click **Browse** next to the **Local Upgrade** field, locate the upgrade file, select **UpgradeBoot Program**, click **Upgrade**, and then confirm to start the upgrade. The device will restart and display the login screen after completing the restart.



CAUTION!

- Do not power off the device during upgrade.
- A progress bar will be displayed. Please wait patiently and avoid other operations. After the upgrade is complete, check to ensure that the device has been upgraded to the correct version.







5 IMSPortal Management

1. Open a browser and enter imsportal.ezcloud.uniview.com. Register and login the Portal interface.
2. Click  to create an organization. Click  to add the device using the register code on the intelligent cloud management server.
3. Click  to view the mounted power management module. Click  to perform remote control.

Power Management Module ⊖ * □

- Supports remotely restarting the router, intelligent cloud management server, and outlets (AC models only).
- Enable: Toggles the enabled/disabled status of each functional port on the power management module.
- Auto Temperature Control: If enabled, the heater will automatically turn on when the temperature falls below the low temperature threshold, and the fan will activate automatically when the temperature exceeds the high temperature threshold.
- Alarm Linkage: If enabled, the power management module will receive alarm output signals from the intelligent cloud management server. When the warning light is on, it will flash simultaneously if the intelligent cloud management server triggers an alarm output.

Power Module Port Control ×

 Router Restart <input checked="" type="checkbox"/>	 SMSERVER Restart <input checked="" type="checkbox"/>	 Socket Restart <input checked="" type="checkbox"/> Switch <input checked="" type="checkbox"/>	 Heater Switch <input checked="" type="checkbox"/> Auto Tem... <input type="checkbox"/>	 Fan Switch <input checked="" type="checkbox"/> Auto Tem... <input type="checkbox"/>	 Warning Light Switch <input type="checkbox"/> Alarm Lin... <input type="checkbox"/>
--	--	--	---	--	--



NOTE!

For additional system configuration needs, click  to go to the login page of the corresponding device's web interface.

6 APP Management

Scan the QR code below to download and install the app.

- Type A



- Type B



NOTE!

For detailed instructions, refer to the user manual of the app.

7 FAQ

The power management module of the DC box cannot access the cloud.

Please restart the intelligent cloud management server to access the cloud. During the upgrade or restart process of the power management module, avoid performing any management operations on the app, Portal, or web, including adding, deleting, unbinding, delivering, sharing, etc.