

4MP Fixed Dome Network Camera

IPC3614LB-ADF28(40)K-H



4MP



Ultra Motion Detection



WDR



Built-in Mic



Edge Storage



Corridor Mode



Edge Storage



POE



IP 67

Features

- High quality image with 4MP, 1/3.0"CMOS sensor
- 4MP (2560*1440)@25/20fps; 3MP (2304*1296)@30/25fps; 2MP (1920*1080)@30/25fps; 720P (1280*720)@30/25fps
- Ultra 265, H.265, H.264, MJPEG
- Smart IR, up to 30m (98ft) IR distance
- Support 512 G Micro SD card
- Support PoE power supply
- 3-Axis

Specifications

Model	IPC3614LB-ADF28K-H	IPC3614LB-ADF40K-H
Camera		

Max Resolution	4 MP	
Sensor	1/3.0" CMOS	
Min. Illumination	Colour: 0.01 lux (F2.0, AGC ON) 0 lux with IR	
Day/Night	IR-cut filter with auto switch (ICR)	
Shutter	Auto/Manual, 1 ~ 1/100000s	
Adjustment Angle	Pan: 0° ~ 360°, Tilt: 0° ~ 80°, Rotate: 0° ~ 360°	
S/N	>52 dB	
WDR	120 dB	
Lens		
Focal Length	2.8 mm	4.0 mm
Iris Type	Fixed	
Iris	F2.0	
Field of View (H)	101.5°	84.1°
Field of View (V)	55.6°	45.1°
Field of View (D)	111.6°	89.5°
DORI		
DORI Distance (Lens)	2.8mm	4.0mm
DORI Distance (Detect)	63.0m(206.7t)	90.0m(295.3ft)
DORI Distance (Observe)	25.2m(82.7ft)	36.0m(118.1ft)
DORI Distance (Recognize)	12.6m(41.3ft)	18.0m(59.1ft)
DORI Distance (Identify)	6.3m(20.7ft)	9.0m(29.5ft)
Illuminator		
Supplemental Light	IR	
Illumination Distance (IR)	30 m (98.4 ft)	
Wavelength	850 nm	
IR On/Off Control	Auto/Manual	
Video		
Video Compression	Ultra 265, H.265, H.264, MJPEG	
H.264 Code Profile	Baseline profile, Main profile, High profile	

Frame Rate	Main Stream: 4MP (2560*1440), Max 25fps; 3MP (2304*1296), Max 30fps; 1080P (1920*1080), Max 30fps; 720P (1280*720), Max 30fps Sub Stream: D1 (720*576), Max 30fps; 640*360,Max 30fps; 2CIF(704*288), Max 30fps; CIF(352*288), Max 30fps;
Video Bit Rate	128 Kbps to 6144 Kbps
U-code	Support
OSD	Up to 4 OSDs
Privacy Mask	Up to 4 areas
ROI	Support
Video Stream	Dual Streams
Image	
White Balance	Auto, Outdoor, Fine Tune, Sodium Lamp, Locked, Auto2
Digital Noise Reduction	2D/3D DNR
Smart IR	Support
Flip	Normal, Flip Vertical, Flip Horizontal, 180°, 90° Clockwise, 90° Anti-clockwise
Dewarping	N/A
HLC	Support
BLC	Support
Defog	Digital Defog
Events	
Basic Detection	Motion Detection, Ultra Motion Detection, Tampering Alarm, Audio Detection, Cross line (based on human body detection), Intrusion (based on human body detection)
General Function	Watermark, IP Address Filtering, Access Policy, ARP Protection, RTSP Authentication, User Authentication
Audio	
Audio Compression	G.711U, G.711A
Audio Bitrate	64 Kbps
Two-way Audio	N/A
Suppression	Support
Sampling Rate	8 kHz
Storage	
Edge Storage	Micro SD, up to 512 GB

Network Storage	ANR, NAS (NFS)
Network	
Protocols	IPv4, IGMP, ICMP, ARP, TCP, UDP, DHCP, RTP, RTSP, RTCP, RTMP, DNS, DDNS, NTP, FTP, UPnP, HTTP, HTTPS, SMTP, QoS, SSL/TLS, SNMP
Compatible Integration	ONVIF (Profile S, Profile G, Profile T), API, SDK
User/Host	Up to 32 users, 2 user levels: administrator and common user
Security	Password Protection, Strong Password, HTTPS Encryption, Export Operation Logs, Basic and Digest Authentication for RTSP, Digest Authentication for HTTP, TLS 1.2, WSSE and Digest Authentication for ONVIF
Client	UNV-Link, UNV-Link Pro, EZStation
Web Browser	Plug-in required live view: IE 10+, Chrome 45+, Firefox 52+, Edge 79+, Plug-in free live view: Chrome 57+, Firefox 58+, Edge 16+
Interface	
Audio I/O	N/A
Alarm I/O	N/A
Serial Port	N/A
Built-in Mic	Support
Built-in Speaker	N/A
WIFI	N/A
Network	1 × RJ45 10 M/100 M Base-TX Ethernet
Video Output	N/A
Certification	
EMC	CE-EMC (EN 55032, EN 61000-3-3, EN IEC 61000-3-2, EN 55035) FCC (FCC 47 CFR part15 B)
Safety	CE LVD (EN 62368-1) CB (IEC 62368-1) UL/CUL (UL 62368-1, CAN/CSA C22.2 No. 62368-1)
Environment	CE-RoHS (2011/65/EU;(EU)2015/863); WEEE (2012/19/EU);
Protection	IP67 (IEC 60529)
General	
Power	DC 12V±25%, PoE (IEEE 802.3af)
Power Consumption	Max 7.0W

Power Interface	Ø5.5 mm coaxial power plug
Dimensions	Ø118 x 96mm (Ø4.6" x 3.8") (Ø x H)
Weight	0.30kg (0.66lb)
Material	Metal + Plastic
Working Environment	-30 °C to 60 °C (-22 °F to 140 °F), Humidity: ≤ 95% RH (non-condensing)
Storage Environment	-30 °C to 60 °C (-22 °F to 140 °F), Humidity: ≤ 95% RH (non-condensing)
Surge Protection	4 KV
Reset Button	N/A
Web Client Language	4 Languages: English, Russian, Spanish, Vietnamese

Dimensions

Aggregate product size diagram using "main model" as an example

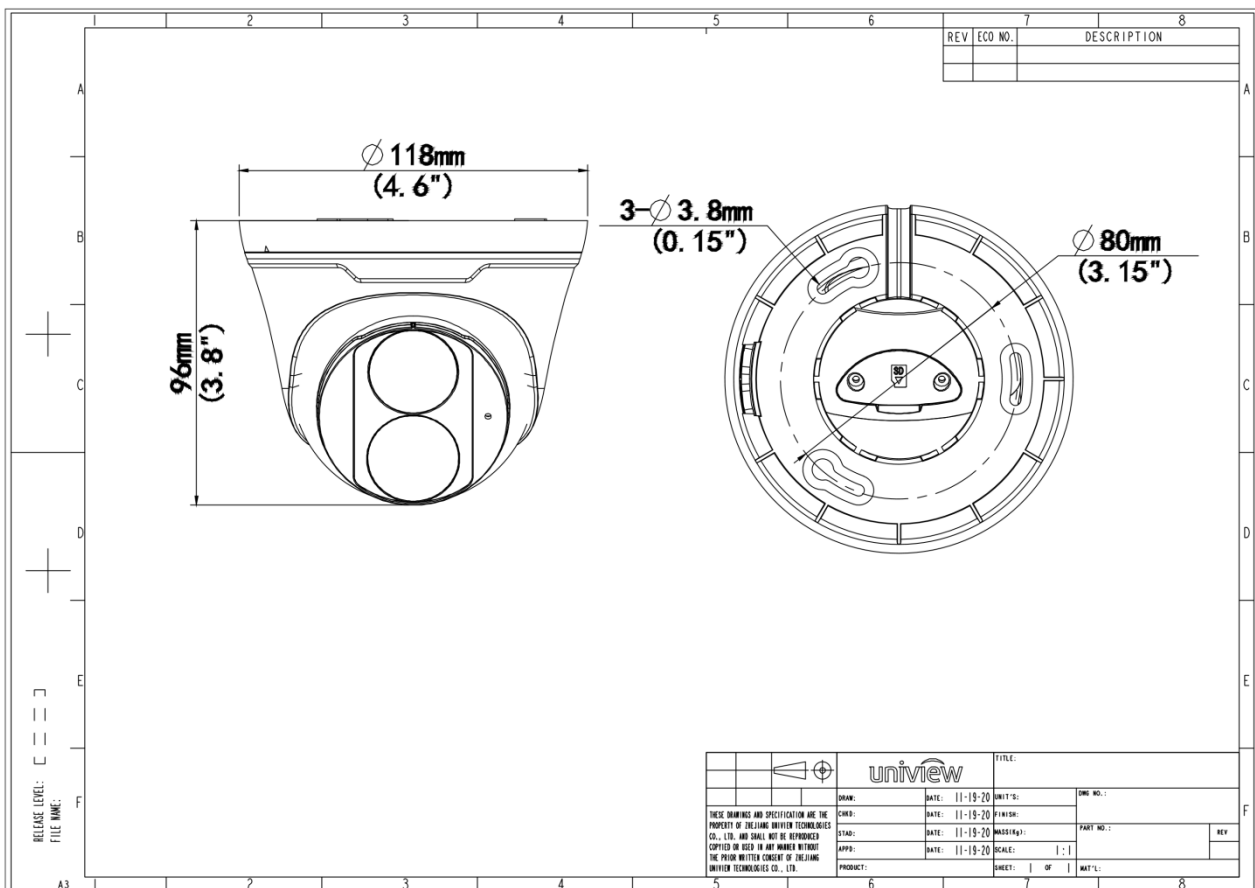

Accessories

TR-JB03-I-IN

Junction Box for Plastic Turret Camera
(Support wiring from behind)



TR-JB07/WM03-G-IN

Wall Mounting Assembling Bracket For
32 Fix-dome&Mini Fix-dome&Plastic Turret Camera



TR-WM03-D-IN

Wall Mounting Bracket for 32 Fix-dome&Mini Fix-dome&Plastic Turret Camera



TR-A01-IN

NPT 3/4" Waterproof Cable Gland



TR-UP06-IN

Universal Pole Mounting Bracket



TR-UC08-C

Bullet&Dome Corner Mounting Bracket

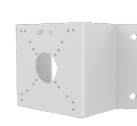

TR-SE24-IN

Dome Pendant Mounting Pole 200m



TR-SE24-A-IN

Dome Pendant Mounting Pole 500m



TR-CM24-IN

Dome Pendant Mounting Bracket(Indoor)



Zhejiang Uniview Technologies Co., Ltd.

No. 369, Xietong Road, Xixing Sub-district, Binjiang District, Hangzhou City, 310051, Zhejiang Province, China

Email: overseasbusiness@uniview.com; globalsupport@uniview.com

<http://www.uniview.com>

©2023-2025 Zhejiang Uniview Technologies Co., Ltd. All rights reserved.

*Product specifications and availability are subject to change without notice.

*Despite our best efforts, technical or typographical errors may exist in this document. Uniview cannot be held responsible for any such errors and reserves the right to change the contents of this document without prior notice.