

## 2MP Fixed IR Turret Network Camera IPC3612LB-AF28K-A2



### Features

- High quality image with 1080P, 1/3.0" CMOS sensor
- 1080P (1920 × 1080)@30/25 fps; 720P (1280 × 720)@30/25 fps
- Supports accurate human body detection 2.0
- Ultra 265, H.265, H.264
- Built-in mic
- Smart IR, up to 30 m (98.4 ft.) IR distance
- Day/night functionality
- 2D/3D DNR (digital noise reduction)
- MicroSD, up to 512 GB
- DC 12 V, PoE (IEEE 802.3af) power supply
- IP67 protection
- 3-axis

## Specifications

Model	IPC3612LB-AF28K-A2
<b>Camera</b>	
Max Resolution	2 MP
Sensor	1/3.0" CMOS
Min. Illumination	Color: 0.01 Lux (F2.0, AGC ON), 0 Lux with IR on
Day/Night	IR-cut filter with auto switch (ICR)
Shutter	Auto/Manual, 1 ~ 1/100000s
Adjustment Angle	Pan: 0° to 360°, Tilt: 0° to 80°, Rotate: 0° to 360°
S/N	>52 dB
WDR	DWDR
<b>Lens</b>	
Focal Length	2.8 mm
Iris Type	Fixed
Iris	F2.0
Field of View (H)	100.0°
Field of View (V)	56.5°
Field of View (D)	114.4°
Lens Type	Fixed
<b>DORI</b>	
DORI Distance (Lens)	2.8 mm
DORI Distance (Detect)	46.7 m (153.1 ft.)
DORI Distance (Observe)	18.7 m (61.4 ft.)
DORI Distance (Recognize)	9.3 m (30.6 ft.)
DORI Distance (Identify)	4.7 m (15.4 ft.)
<b>Illuminator</b>	
Supplemental Light	IR
Illumination Distance (IR)	30 m (98.4 ft.)
Wavelength	850 nm
IR On/Off Control	Auto/Manual
<b>Video</b>	
Video Compression	Ultra 265, H.265, H.264
H.264 Code Profile	Baseline profile, Main profile, High profile
Frame Rate	Main Stream: 1080P (1920 × 1080), max. 30 fps; 720P (1280 × 720), max. 30 fps Sub Stream: 640 × 360, max. 30 fps; 2CIF (704 × 288), max. 30 fps; CIF (352 × 288), max. 30 fps
Video Bit Rate	128 Kbps to 6144 Kbps
U-code	Support
OSD	Up to 4 OSDs
Privacy Mask	Up to 4 areas
ROI	Support
Video Stream	Dual streams
<b>Image</b>	







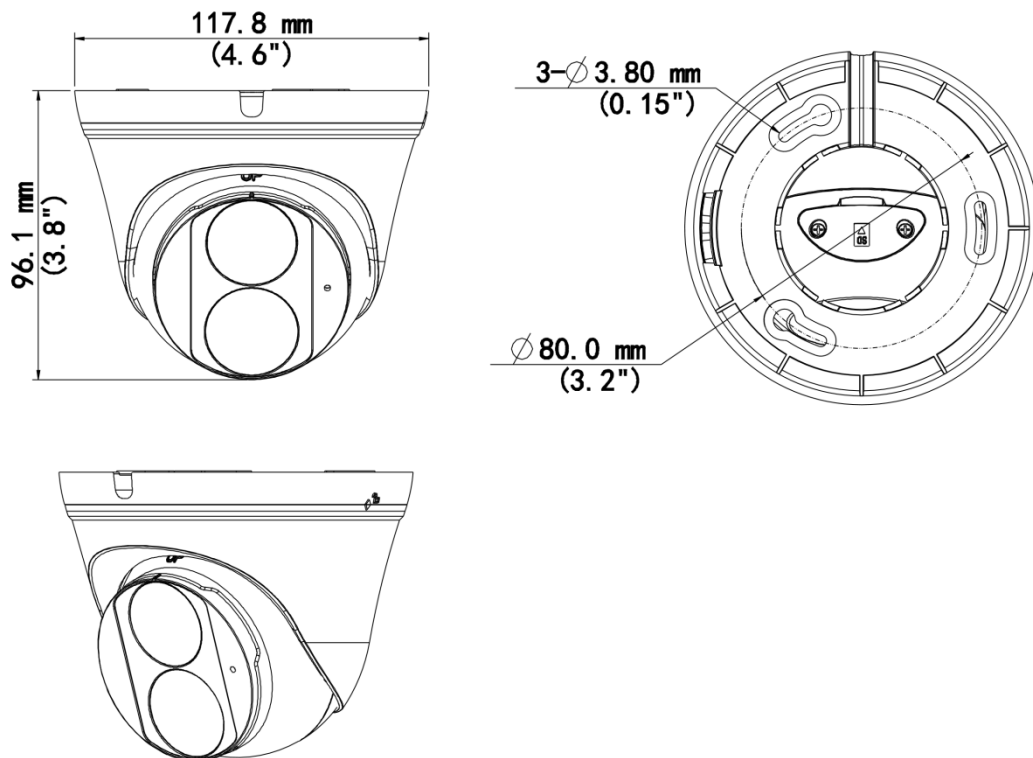

White Balance	Auto, Outdoor, Fine tune, Sodium lamp, Locked, Auto2, Area white balance
Digital Noise Reduction	2D/3D DNR
Smart IR	Support
Flip	Normal, Flip vertical, Flip horizontal, 180°
Dewarping	N/A
HLC	Support
BLC	Support
Defog	Digital defog
Image Stabilization	N/A
<b>Events</b>	
Basic Detection	Human body detection 2.0, Motion detection, Audio detection
General Function	Watermark, IP address filtering, Access policy, ARP protection, RTSP authentication, User authentication, HTTP authentication
<b>Audio</b>	
Audio Compression	G.711U, G.711A
Audio Bitrate	64 Kbps
Two-way Audio	N/A
Suppression	Support
Sampling Rate	8 kHz
<b>Storage</b>	
Edge Storage	MicroSD, up to 512 GB
<b>Network</b>	
Protocols	IPv4, IGMP, ICMP, ARP, TCP, UDP, DHCP, RTP, RTSP, RTCP, RTMP, DNS, DDNS, NTP, UPnP, HTTP, HTTPS, QoS, SSL/TLS
Compatible Integration	API, SDK
User/Host	Up to 32 users, 2 user levels: administrator and common user
Security	Password Protection, Strong Password, HTTPS Encryption, Export Operation Logs, Basic and Digest Authentication for RTSP, Digest Authentication for HTTP, TLS 1.2, WSSE and Digest Authentication for ONVIF
Client	EZStation, APP
Web Browser	Plug-in free live view: Chrome 57+, Firefox 58+, Edge 16+, Plug-in required live view: IE 10+, Chrome 45+, Firefox 52+, Edge 79+
<b>Interface</b>	
Audio I/O	N/A
Alarm I/O	N/A
Serial Port	N/A
Built-in Mic	Support
Built-in Speaker	N/A
WIFI	N/A
Network	1 × RJ45 10 M/100 M Base-TX Ethernet
Video Output	N/A
<b>Certification</b>	
EMC	CE-EMC (EN 55032, EN 61000-3-3, EN IEC 61000-3-2, EN 50130-4)

	FCC (FCC 47 CFR part15 B)
Safety	CE-LVD (EN 62368-1)
Environment	CE-RoHS (2011/65/EU ; (EU) 2015/863) ; WEEE (2012/19/EU)
Protection	IP67 (IEC 60529)
<b>General</b>	
Power	DC 12 V±25%, PoE (IEEE 802.3af)
Power Consumption	Max. 3.9 W
Power Interface	Ø5.5 mm coaxial power plug
Dimensions	Ø118 mm × 95 mm (Ø4.6" × 3.8") (Ø × H)
Weight	0.25 kg (0.55 lb.)
Material	Graphene + Plastic
Storage Environment	-30 °C to 60 °C (-22 °F to 140 °F), Humidity: ≤ 95% RH (non-condensing)
Working Environment	-30 °C to 60 °C (-22 °F to 140 °F), Humidity: ≤ 95% RH (non-condensing)
Surge Protection	4 KV
Reset Button	N/A
Web Client Language	4 Languages: English, Russian, Spanish, Vietnamese

## Dimensions

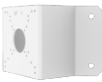

## Accessories

<p><b>TR-JB03-I-IN</b> Junction Box for Turret Camera(Support wiring from behind)</p>	<p><b>TR-CM24-IN</b> Dome Pendant Mounting Bracket(Indoor)</p>	<p><b>TR-SE24-A-IN</b> Dome Pendant Mounting Pole 500mm</p>
		
<p><b>TR-A01-IN</b> NPT 3/4" Waterproof Cable Gland</p>	<p><b>TR-SE24-IN</b> Dome Pendant Mounting Pole 200mm</p>	<p><b>TR-JB07/WM03-G-IN-V2</b> Wall Mounting Assembling Bracket For 32 Fix-dome&amp;Mini Fix-dome&amp;Plastic Turret Camera</p>
		
<p><b>TR-WM03-D-IN-V2</b> Wall Mounting Bracket for 32 Fix-dome&amp;Mini Fix-dome&amp;Plastic Turret Camera</p>	<p><b>TR-UC08-C-V2</b> Bullet&amp;Dome Corner Mounting Bracket</p>	<p><b>TR-UP06-C-IN-V2</b> Pole Mounting Bracket for Bullet Junction Box Only</p>
		
<p><b>TR-WM07P-B</b> Dome Wall Mounting Plastic Bracket</p>		
		

# Unlimited New View

## Zhejiang Uniview Technologies Co., Ltd.

 <http://www.uniview.com>

 [overseasbusiness@uniview.com](mailto:overseasbusiness@uniview.com); [globalsupport@uniview.com](mailto:globalsupport@uniview.com)

 No. 369, Xietong Road, Xixing Sub-district, Binjiang District, Hangzhou City, 310051, Zhejiang Province, China



©2023-2025 Zhejiang Uniview Technologies Co., Ltd. All rights reserved.

\*Product specifications and availability are subject to change without notice.

Despite our best efforts, technical or typographical errors may exist in this document. Uniview cannot be held responsible for any such errors and reserves the right to change the contents of this document without prior notice.