

8MP Lighthunter WDR IR Network Dome Camera IPC3738SE-ADZK-IO

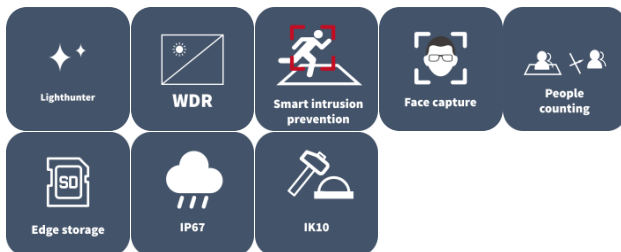

Features

- High quality image with 8 MP, 1/1.8" CMOS sensor
- 3840 × 2160@30 fps in the main stream
- Ultra 265, H.265, H.264, MJPEG
- Smart intrusion prevention, supports false alarm filtering, including cross line, intrusion, enter area, leave area detection
- People counting, supports people flow counting and crowd density monitoring, suitable for different statistical scenarios
- LightHunter technology ensures ultra-high image quality in low illumination environment
- Up to 120 dB optical WDR (wide dynamic range)
- Built-in heater, supports normal start-up at low temperature
- DC 12 V, PoE (IEEE 802.3af) power supply
- Wide voltage range of $\pm 25\%$ in DC
- Alarm I/O: 2/1, audio I/O: 1/1

Specifications

Model	IPC3738SE-ADZK-I0
Camera	
Sensor	1/1.8" CMOS
Min. Illumination	Color: 0.0008 Lux (F1.2, AGC ON), 0 Lux with IR
Day/Night	IR-cut filter with auto switch (ICR)
Shutter	Auto/Manual, 1 to 1/100000 s
WDR	120 dB
S/N	>56 dB
Lens	
Focal Length	2.8 to 12 mm
Digital Zoom	16X
Optical Zoom	5X
Iris	F1.2
Field of View (H)	101.1° to 48.0°
Field of View (V)	57.2° to 23.9°
Field of View (D)	124.3° to 59.0°
Iris Type	Fixed
DORI	
DORI Distance (Lens)	2.8 to 12 mm
DORI Distance (Detect)	98.6 m to 241.0 m (323.3 ft. to 790.6 ft.)
DORI Distance (Observe)	39.4 m to 96.4 m (129.3 ft. to 316.2 ft.)
DORI Distance (Recognize)	19.7 m to 48.2 m (64.7 ft. to 158.1 ft.)
DORI Distance (Identify)	9.9 m to 24.1 m (32.3 ft. to 79.1 ft.)
Video	
Video Compression	Ultra 265, H.265, H.264, MJPEG
Video Bit Rate	128 Kbps to 16 Mbps
U-code	Support
ROI	Support
Video Stream	Triple streams
Privacy Mask	Up to 4 areas
OSD	Up to 10 OSDs
Frame Rate-Main Stream	8 MP (3840 × 2160), max. 30 fps
Frame Rate-Sub Stream	720P (1280 × 720), max. 30 fps
Frame Rate-Third Stream	D1 (720 × 576), max. 30 fps
Intelligent	
Exception Detection	Object removed, Object Left Behind, Scene change, Defocus detection
Smart Intrusion Prevention	Cross line detection, intrusion detection, enter area detection, leave area detection (support false alarm filtering and the classification of human, non-motor vehicle and vehicle)
People Counting	Support people flow counting and crowd density detection
Road Traffic	Support capturing car license picture when the car passes tripwire, Up to 4 lanes can be set, Two types of application mode available: High/Low pole



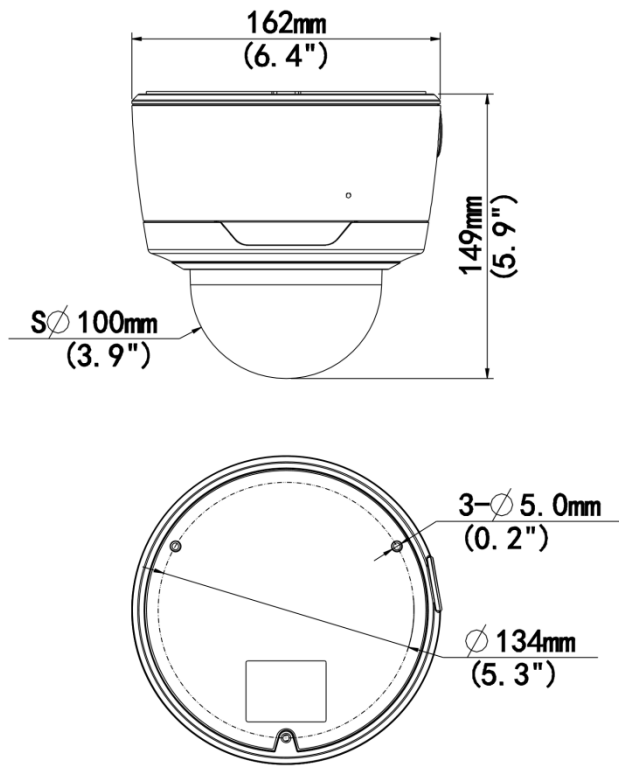

Image	
White Balance	Auto, Outdoor, Fine tune, Sodium lamp, Locked, Auto2
Digital Noise Reduction	2D/3D DNR
Flip	Normal, Flip vertical, Flip horizontal, 180°
HLC	Support
BLC	Support
Smart IR	Support
Defog	Digital defog
Heatwave Reduction	N/A
Events	
Basic Detection	Motion detection, Tampering alarm, Audio detection, Object removed, Object Left Behind, Scene change
General Function	Watermark, IP address filtering, Access policy, ARP protection, RTSP authentication, User authentication, HTTP authentication, Alarm input, Alarm output
Audio	
Audio Compression	G.711U, G.711A
Audio Bitrate	128 Kbps
Two-way Audio	Support
Suppression	Support
Sampling Rate	16KHZ
Storage	
Edge Storage	MicroSD, up to 512 GB
Network Storage	ANR, NAS (NFS)
Network	
Protocols	SSH, IGMP, RTP, RTCP, SMTP, IPv4, IPv6, ICMP, ARP, TCP, UDP, DHCP, PPPoE, RTSP, RTMP, DNS, DDNS, NTP, FTP, UPnP, HTTP, HTTPS, 802.1x, SNMP, QoS, SSL/TLS
Compatible Integration	ONVIF (Profile S, Profile G, Profile T, Profile M), API, SDK
User/Host	Up to 32 users. 3 user levels: administrator, common user and operator
Security	TLS 1.3, Password Protection, Strong Password, HTTPS Encryption, Export Operation Logs, Basic and Digest Authentication for RTSP, Digest Authentication for HTTP, TLS 1.2, WSSE and Digest Authentication for ONVIF
Client	EZStation, UNV-Link, UNV-Link Pro
Web Browser	Plug-in required live view: IE 10+, Chrome 45+, Firefox 52+, Edge 79+, Plug-in free live view: Chrome 57+, Firefox 58+, Edge 16+
Illuminator	
Illumination Distance (IR)	40 m (131.2 ft.)
IR On/Off Control	Auto/Manual
Wavelength	850 nm
Interface	
Audio I/O	1 Input: impedance 1 k Ω , amplitude 2.5 V [p-p], 1 Output: impedance 600 Ω , amplitude 2.5 V [p-p]
Alarm I/O	2/1
Built-in Mic	Support
Network	1 \times RJ45 10 M/100 M Base-TX Ethernet

Video Output	1 BNC (for debugging)
Certification	
EMC	CE-EMC (EN 55032: 2015+A1:2020,EN 61000-3-3: 2013+A1: 2019,EN IEC 61000-3-2: 2019+A1: 2021,EN 55035: 2017+A11:2020) FCC (FCC CFR 47 part15 B, ANSI C63.4-2014)
Safety	CE LVD (EN 62368-1:2014+A11:2017) UL (UL 62368-1, 2nd Ed., Issue Date: 2014-12-01)
Environment	CE-RoHS (2011/65/EU;(EU)2015/863); WEEE (2012/19/EU); Reach (Regulation (EC) No 1907/2006)
Protection	IP67 (IEC 60529:1989+AMD1:1999+AMD2:2013) IK10 (IEC 62262:2002)
General	
Power	DC 12 V (±25%), PoE (IEEE 802.3af)
Power Consumption	Max. 10 W
Power Interface	Ø5.5 mm coaxial power plug
Dimensions	Ø162 mm × 149 mm (Ø6.4" × 5.9") (Ø × H)
Weight	1.5 kg (3.31 lb.)
Working Environment	-40 °C to 60 °C (-40 °F to 140 °F), Humidity: ≤ 95% RH (non-condensing)
Storage Environment	-40 °C to 70 °C (-40 °F to 158 °F), Humidity: ≤ 95% RH (non-condensing)
Reset Button	Support
Web Client Language	22 Languages: Traditional Chinese, English, Simplified Chinese, Polish, German, Russian, French, Korean, Dutch, Czech, Portuguese (Europe), Portuguese (Brazil), Japanese, Thai, Turkish, Spanish (Latin America), Spanish (Europe), Hungarian, Italian, Vietnamese, Arabic, Slovak
Heater	Support
Configurable	
P/N	Support

Dimensions



Accessories

<p>TR-WM04-IN 4 Inch Hemisphere Wall Mounting Bracket</p>	<p>TR-UP06-IN Universal Pole Mounting Bracket</p>	<p>TR-SE24-IN Dome Pendant Mounting Pole 200mm</p>
		
<p>TR-SE24-A-IN Dome Pendant Mounting Pole 500mm</p>	<p>TR-CM24-IN Dome Pendant Mounting Bracket(Indoor)</p>	
		

Unlimited New View

Zhejiang Uniview Technologies Co., Ltd.

 <http://www.uniview.com>

 overseasbusiness@uniview.com; globalsupport@uniview.com

 No. 369, Xietong Road, Xixing Sub-district, Binjiang District, Hangzhou City, 310051, Zhejiang Province, China



©2023-2025 Zhejiang Uniview Technologies Co., Ltd. All rights reserved.

*Product specifications and availability are subject to change without notice.

Despite our best efforts, technical or typographical errors may exist in this document. Uniview cannot be held responsible for any such errors and reserves the right to change the contents of this document without prior notice.