

8MP+8MP LightHunter Dual-lens Network PTZ Camera IPC68188EFW-X25-F40G-VH

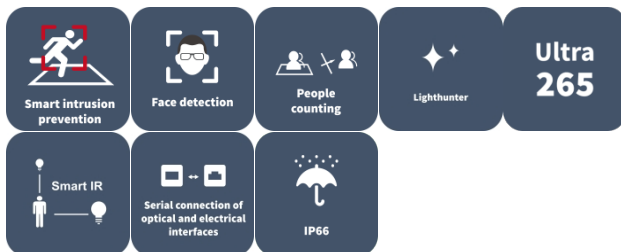

Features

- Dual-channel with one IP, provides overall view and detailed view at the same time
- Supports dual-lens video spliced in one channel, which can obtain a wider monitoring range
- Ultra 265, H.265, H.264, MJPEG
- Gyroscope stabilization for stable picture
- 25X optical zoom of PTZ channel allows for closer viewing of subjects
- Smart intrusion prevention, supports false alarm filtering, including cross line, intrusion, enter area, leave area detection
- automatic selection of best snapshots, supports face detection masked area
- supports front-end , supports blocklist and allowlist comparison
- People counting, supports people flow counting and crowd density monitoring, suitable for different statistical scenarios
- LightHunter technology ensures ultra-high image quality in low illumination environment
- IR and warm light illumination to deal with different scenes and achieve full-color illumination
- AC 24 V±25%, DC 24 V±25% power supply

Specifications

Channel	Channel 1 (Panorama)	Channel 2 (Detail)
Camera		
Max Resolution	8 MP	
Sensor	1/1.8" CMOS	1/1.2" CMOS
Min. Illumination	Color: 0.0005 Lux (F1.6, AGC ON), 0 lux with IR/Warm light	Color: 0.0005 Lux (F1.6, AGC ON), 0 lux with IR
Day/Night	IR-cut filter with auto switch (ICR)	
Shutter	Auto/Manual, 1 to 1/100000 s	
WDR	120 dB	
S/N	>56 dB	
Lens		
Digital Zoom	N/A	16X
Optical Zoom	N/A	25X
Iris Type	Fixed	P-iris
Intelligent		
Metadata Analyse	Support human body, human face, motor vehicle and non-motor vehicle image capture and attribute collection	
Smart Intrusion Prevention	Cross line detection, intrusion detection, enter area detection, leave area detection (support false alarm filtering and the classification of human, non-motor vehicle and vehicle)	
People Counting	N/A	Support people flow counting and crowd density detection
DORI		
DORI Distance (Lens)	4 mm	10 to 250 mm
Video		
Privacy Mask	24 areas, up to 8 areas per scene	
Frame Rate-Main Stream	8 MP (3840 × 2160), max. 30 fps; 6 MP (3072 × 2048), max. 30 fps; 4 MP (2688 × 1520), max. 30 fps; 4 MP (2560 × 1440), max. 30 fps; 1080P (1920 × 1080), max. 30 fps; 720P (1280 × 720), max. 30 fps; D1 (720 × 576), max. 30 fps; 640 × 360, max. 30 fps; 2CIF (704 × 288), max. 30 fps; CIF (352 × 288), max. 30 fps;	
Frame Rate-Sub Stream	1080P (1920 × 1080), max. 30 fps; 720P (1280 × 720), max. 30 fps; D1 (720 × 576), max. 30 fps; 640 × 360, max. 30 fps; 2CIF (704 × 288), max. 30 fps; CIF (352 × 288), max. 30 fps	
Frame Rate-Third Stream	D1 (720 × 576), max. 30 fps; 640 × 360, max. 30 fps; 2CIF (704 × 288), max. 30 fps; CIF (352 × 288), max. 30 fps	
Video Compression	Ultra 265, H.265, H.264, MJPEG	
Frame Rate Recommendation	3840 × 2160@30 fps + 1080P@30 fps + D1@30 fps 3072 × 2048@30 fps + 1080P@30 fps + D1@30 fps	
Video Bit Rate	128 Kbps to 16 Mbps	
U-code	Support	
ROI	Support	
Video Stream	Triple streams	
OSD	Up to 10 OSDs	





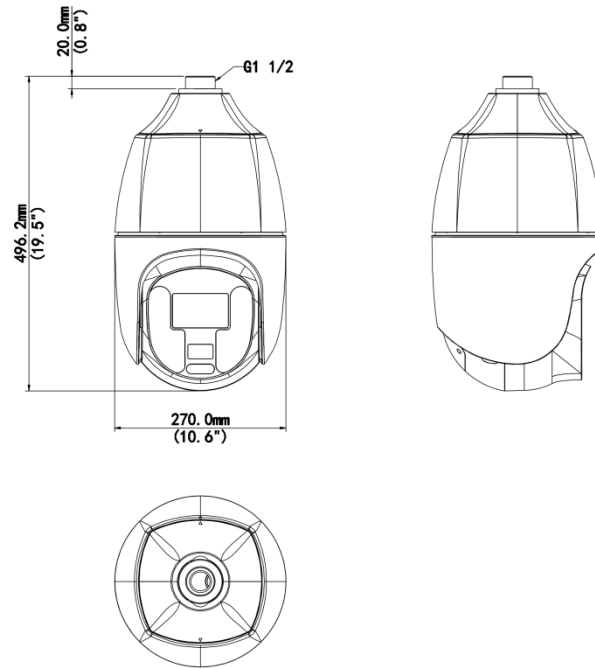

Image		
White Balance	Auto, Outdoor, Fine tune, Sodium lamp, Locked, Auto2	
Digital Noise Reduction	2D/3D DNR	
Flip	Normal, Flip vertical, Flip horizontal, 180°	
HLC	Support	
BLC	Support	
Smart IR	N/A	Support
Defog	Digital defog	Optical defog
Heatwave Reduction	N/A	Support
Illuminator		
Light On/Off Control	Auto/Manual	
Illumination Distance (IR)	N/A	250 m (820.2 ft.)
Illumination Distance (Warm Light)	30 m (98.4 ft.)	N/A
Events		
Basic Detection	Motion detection, Audio detection, Tampering alarm	
General Function	Watermark, IP address filtering, Alarm input, Alarm output, Access policy, ARP protection, RTSP authentication, User authentication	Watermark, IP address filtering, Access policy, Alarm output, Alarm input, User authentication, RTSP authentication, ARP protection
Audio		
Audio Compression	G.711U, G.711A	
Audio Bitrate	128 Kbps	
Two-way Audio	Support	
Suppression	Support	
Sampling Rate	8 kHz, 16 kHz	
Storage		
Edge Storage	MicroSD, up to 512 GB	
Network Storage	ANR, NAS (NFS)	
Network		
Protocols	SSH, IGMP, RTP, RTCP, SMTP, IPv4, IPv6, ICMP, ARP, TCP, UDP, DHCP, PPPoE, RTSP, RTMP, DNS, DDNS, NTP, FTP, UPnP, HTTP, HTTPS, 802.1x, SNMP, QoS, SSL/TLS	
Compatible Integration	ONVIF (Profile S, Profile G, Profile T, Profile M), API, SDK	ONVIF (Profile S, Profile G, Profile T), API, SDK
User/Host	Up to 32 users. 3 user levels: administrator, common user and operator	
Security	TLS 1.3, Password Protection, Strong Password, HTTPS Encryption, Export Operation Logs, Basic and Digest Authentication for RTSP, Digest Authentication for HTTP, TLS 1.2, WSSE and Digest Authentication for ONVIF	
Client	EZStation, UNV-Link, UNV-Link Pro	
Web Browser	Plug-in required live view: IE 10+, Chrome 45+, Firefox 52+, Edge 79+	
PTZ		
Number of Presets	N/A	1024
Preset Patrol	N/A	16 patrols, up to 64 presets for each patrol





Preset Image Freeze	N/A	Support
Patrol Stay Time	15 s to 1800 s	
Home Position	N/A	Support
Pan Range	360°	
Tilt Range	-15° to 90°	
Pan Speed	0.1°/s to 180°/s	
Tilt Speed	0.1°/s to 180°/s	
Interface		
WIFI	N/A	
Audio I/O	1 Input: impedance 1 kΩ, amplitude 2.5 V [p-p], 1 Output: impedance 600 Ω, amplitude 2 V [p-p]	
Alarm I/O	7/2	
Serial Port	1 × RS485	
Built-in Mic	N/A	
Built-in Speaker	N/A	
Network	1 × RJ45 10 M/100 M/1000 M Base-TX Ethernet + 1 × 100 M/1000 M SFP	
Certification		
EMC	CE-EMC (EN 55032: 2015+A1: 2020, EN 61000-3-3: 2013+A1: 2019, EN IEC 61000-3-2: 2019+A1: 2021, EN 55035: 2017+A11: 2020) FCC (FCC CFR 47 part15 B, ANSI C63.4-2014)	
Safety	CE LVD (EN 62368-1:2014+A11:2017) UL (UL 62368-1, 2nd Ed., Issue Date: 2014-12-01)	
Environment	CE-RoHS (2011/65/EU; (EU) 2015/863)	
Protection	IP66 (IEC 60529: 1989+AMD1: 1999+AMD2: 2013) IK10 (IEC 62262, Anti-Vandalism Except for the Front Window)	
General		
Power	DC 24 V (±25%), AC 24 V (±25%)	
Power Consumption	Max. 63 W	
Power Interface	Wires with cold-pressed terminal	
Dimensions	Ø270 mm × 497 mm (Ø 10.6" × 19.6") (Ø × H)	
Weight	10.08 kg (22.2 lb.)	
Working Environment	-40 °C to 70 °C (-40 °F to 158 °F), Humidity: ≤ 95% RH (non-condensing)	
Storage Environment	-40 °C to 70 °C (-40 °F to 158 °F), Humidity: ≤ 95% RH (non-condensing)	
Surge Protection	6 KV	
Reset Button	Support	
Web Client Language	22 Languages: Traditional Chinese, English, Simplified Chinese, Polish, German, Russian, French, Korean, Dutch, Czech, Portuguese (Europe), Portuguese (Brazil), Japanese, Thai, Turkish, Spanish (Latin America), Spanish (Europe), Hungarian, Italian, Vietnamese, Arabic, Slovak	

Dimensions



Accessories

TR-UF45-A-IN Dome Indoor Ceiling Mounting Pedestal	TR-SE45-A-IN Dome Ceiling Mounting Pole 500	TR-UC08-B-IN Aluminium Alloy Corner Mounting Bracket
		
TR-UC08-A-IN Dome Corner Mounting Bracket	TR-UP08-B-IN Aluminium Alloy Pole Mounting Bracket	TR-UP08-A-IN Dome Pole Mounting Bracket
		

<p>TR-WE45-B-IN Dome Gooseneck Bracket</p>	<p>TR-JB12-IN Dome Junction Box</p>	<p>TR-WE45-A-IN Long Wall Mounting Bracket for Dome</p>
		
<p>TR-CE45-IN Dome Indoor Ceiling Mounting Bracket</p>	<p>TR-SE45-IN Dome Ceiling Mounting Pole 200</p>	
		

Unlimited New View

Zhejiang Uniview Technologies Co., Ltd.



<http://www.uniview.com>



overseasbusiness@uniview.com; globalsupport@uniview.com



No. 369, Xietong Road, Xixing Sub-district, Binjiang District, Hangzhou City, 310051, Zhejiang Province, China



©2023-2025 Zhejiang Uniview Technologies Co., Ltd. All rights reserved.

*Product specifications and availability are subject to change without notice.

Despite our best efforts, technical or typographical errors may exist in this document. Uniview cannot be held responsible for any such errors and reserves the right to change the contents of this document without prior notice.