

# 2MP 33X lightHunter Laser IR Network PTZ Camera IPC6652EL-X33-VF



## Features

- High quality image with 1080P, 1/2.8" CMOS sensor
- 1920 × 1080@60 fps in the main stream
- Ultra 265, H.265, H.264, MJPEG
- 33X optical zoom
- Smart intrusion prevention, supports false alarm filtering, including cross line, intrusion, enter area, leave area detection
- automatic selection of best snapshots, supports face detection masked area
- People counting, supports people flow counting and crowd density monitoring, suitable for different statistical scenarios
- LightHunter technology ensures ultra-high image quality in low illumination environment
- Vari-focal laser: 500 m (1640 ft) distance, proportional to optical zoom of camera module
- AC 24 V±25%, DC 24 V±25%, PoE (PSE required)
- Alarm I/O: 2/1, audio I/O: 1/1
- IP66 ingress protection

## Specifications

Model	IPC6652EL-X33-VF
<b>Camera</b>	
Sensor	1/2.8" CMOS
Min. Illumination	Color: 0.001 Lux (F1.5, AGC ON), 0 Lux with IR
Day/Night	IR-cut filter with auto switch (ICR)
Shutter	Auto/Manual, 1 to 1/100000 s
WDR	120 dB
S/N	>52 dB
<b>Lens</b>	
Focal Length	4.5 to 148.5 mm
Optical Zoom	33X
Digital Zoom	16X
Iris	F1.5 to F4.0
Field of View (H)	56.2° to 2.6°
Field of View (V)	33.5° to 1.4°
Field of View (D)	69.2° to 3.0°
<b>Illuminator</b>	
Vari-focal Laser	Up to 500 m (1640.4 ft.)
Light On/Off Control	Auto/Manual
Wavelength	850 nm
<b>DORI</b>	
DORI Distance (Lens)	4.5 to 148.5 mm
DORI Distance (Detect)	72.9 m to 2187.9 m (239.2 ft. to 7178.2 ft.)
DORI Distance (Observe)	29.2 m to 875.2 m (95.7 ft. to 2871.3 ft.)
DORI Distance (Recognize)	14.6 m to 437.6 m (47.9 ft. to 1435.7 ft.)
DORI Distance (Identify)	7.3 m to 218.8 m (24.0 ft. to 717.8 ft.)
<b>Video</b>	
Video Compression	Ultra 265, H.265, H.264, MJPEG
Frame Rate	Main Stream: 1080P (1920 × 1080), max. 60 fps Sub Stream: 1080P (1920 × 1080), max. 60 fps Third Stream: D1 (720 × 576), max. 60 fps
Video Bit Rate	128 Kbps to 16 Mbps
U-code	Support
ROI	Support
Video Stream	Triple streams
Privacy Mask	24 areas, up to 4 areas per scene
OSD	Up to 10 OSDs
<b>Events</b>	
Basic Detection	Motion detection, Tampering alarm, Audio detection, Object removed, Object Left Behind
General Function	Watermark, IP address filtering, Access policy, ARP protection, RTSP authentication, User authentication, Alarm input, Alarm output





Audio	
Audio Compression	G.711U, G.711A
Audio Bitrate	128 Kbps
Two-way Audio	Support
Suppression	Support
Sampling Rate	16KHZ
Storage	
Edge Storage	MicroSD, up to 512 GB
Network Storage	ANR, NAS (NFS)
Network	
User/Host	Up to 32 users. 3 user levels: administrator, common user and operator
Protocols	SSH, IGMP, RTP, RTCP, SMTP, IPv4, IPv6, ICMP, ARP, TCP, UDP, DHCP, PPPoE, RTSP, RTMP, DNS, DDNS, NTP, FTP, UPnP, HTTP, HTTPS, 802.1x, SNMP, QoS, SSL/TLS
Compatible Integration	ONVIF (Profile S, Profile G, Profile T, Profile M), API, SDK
Security	TLS 1.3, Password Protection, Strong Password, HTTPS Encryption, Export Operation Logs, Basic and Digest Authentication for RTSP, Digest Authentication for HTTP, TLS 1.2, WSSE and Digest Authentication for ONVIF
Client	EZStation, UNV-Link, UNV-Link Pro
Web Browser	Plug-in required live view: IE 10+, Chrome 45+, Firefox 52+, Edge 79+
Intelligent	
Exception Detection	Object removed, Object Left Behind
Smart Intrusion Prevention	Cross line detection, intrusion detection, enter area detection, leave area detection (support false alarm filtering and the classification of human, non-motor vehicle and vehicle)
People Counting	Support people flow counting and crowd density detection
PTZ	
Route Patrol	16 patrols, up to 32 actions for each patrol
Recorded Patrol	16 patrols, up to 128 actions for each patrol
Number of Presets	1024
Preset Image Freeze	Support
Preset Patrol	16 patrols, up to 64 presets for each patrol
Patrol Stay Time	15 s to 1800 s
Home Position	Support
Pan Range	360° (endless)
Pan Speed	0.1°/s to 200°/s
Tilt Range	-15° to 90° (auto reverse)
Tilt Speed	0.1°/s to 200°/s
Image	
White Balance	Auto, Outdoor, Fine tune, Sodium lamp, Locked, Auto2
Digital Noise Reduction	2D/3D DNR
Flip	Normal, Flip vertical, Flip horizontal, 180°
HLC	Support
BLC	Support
Defog	Digital defog

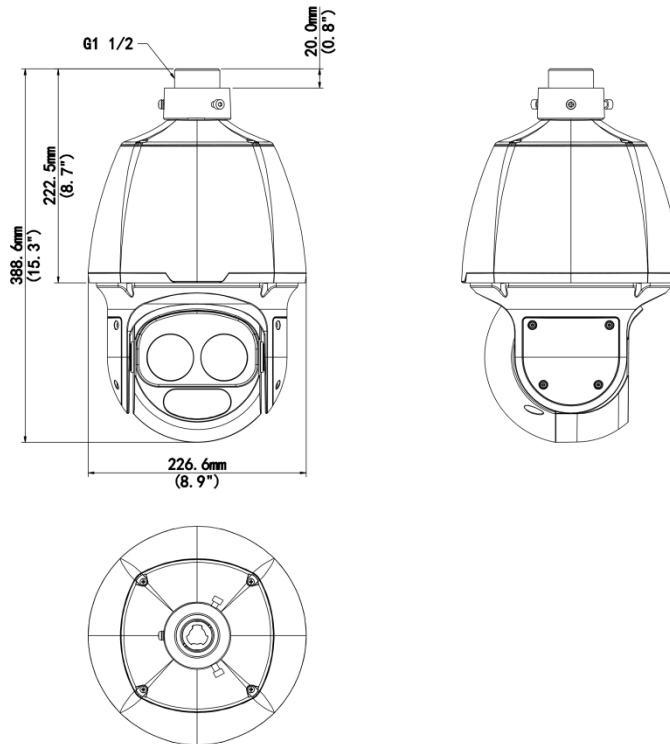





Heatwave Reduction	Support
<b>Interface</b>	
Audio I/O	1 Input: impedance 1 kΩ, amplitude 2.5 V [p-p], 1 Output: impedance 600 Ω, amplitude 2.5 V [p-p]
WIFI	N/A
Alarm I/O	2/1
Serial Port	1 * RS485
Built-in Mic	N/A
Built-in Speaker	N/A
Network	1 × RJ45 10 M/100 M Base-TX Ethernet
Video Output	1 BNC (for debugging)
<b>Certification</b>	
EMC	CE-EMC (EN 55032:2015; EN 55024:2010+A1:2015; EN 61000-3-2:2014; EN 61000-3-3:2013) FCC (FCC CFR 47 part15 B, ANSI C63.4-2014)
Environment	CE-ROHS (2011/65/EU;(EU)2015/863)
Protection	IP66 (IEC 60529:1989+AMD1:1999+AMD2:2013)
<b>General</b>	
Power	AC 24 V±25%, DC 24 V±25%, PoE (PSE Required)
Power Consumption	Max. 53 W
Power Interface	Wires with cold-pressed terminal
Dimensions	Ø270 mm × 385 mm (Ø8.9" × 15.2") (Ø × H)
Weight	5.6 kg (12.35 lb.)
Working Environment	-40 °C to 70 °C (-40 °F to 158 °F), Humidity: ≤ 95% RH (non-condensing)
Storage Environment	-40 °C to 70 °C (-40 °F to 158 °F), Humidity: ≤ 95% RH (non-condensing)
Surge Protection	6 KV
Reset Button	Support
Web Client Language	22 Languages: Traditional Chinese, English, Simplified Chinese, Polish, German, Russian, French, Korean, Dutch, Czech, Portuguese (Europe), Portuguese (Brazil), Japanese, Thai, Turkish, Spanish (Latin America), Spanish (Europe), Hungarian, Italian, Vietnamese, Arabic, Slovak
Heater	Support

# Dimensions



# Accessories

<p><b>TR-UF45-A-IN</b> Dome Indoor Ceiling Mounting Pedestal</p>	<p><b>TR-SE45-A-IN</b> Dome Ceiling Mounting Pole 500</p>	<p><b>TR-SE45-IN</b> Dome Ceiling Mounting Pole 200</p>
		
<p><b>TR-CE45-IN</b> Dome Indoor Ceiling Mounting Bracket</p>	<p><b>TR-WE45-IN</b> Dome Wall Mounting Bracket</p>	<p><b>TR-WE45-A-IN</b> Long Wall Mounting Bracket for Dome</p>
		

<p><b>TR-JB12-IN</b> Dome Junction Box</p>	<p><b>TR-WE45-B-IN</b> Dome Gooseneck Bracket</p>	<p><b>TR-UP08-A-IN</b> Dome Pole Mounting Bracket</p>
		
<p><b>TR-UP08-B-IN</b> Aluminium Alloy Pole Mounting Bracket</p>	<p><b>TR-UC08-A-IN</b> Dome Corner Mounting Bracket</p>	<p><b>TR-UC08-B-IN</b> Aluminium Alloy Corner Mounting Bracket</p>
		
<p><b>Ceiling Mount</b> TR-UF45-A-IN</p>		
		

# Unlimited New View

## Zhejiang Uniview Technologies Co., Ltd.

 <http://www.uniview.com>

 [overseasbusiness@uniview.com](mailto:overseasbusiness@uniview.com); [globalsupport@uniview.com](mailto:globalsupport@uniview.com)

 No. 369, Xietong Road, Xixing Sub-district, Binjiang District, Hangzhou City, 310051, Zhejiang Province, China



©2023-2025 Zhejiang Uniview Technologies Co., Ltd. All rights reserved.

\*Product specifications and availability are subject to change without notice.

Despite our best efforts, technical or typographical errors may exist in this document. Uniview cannot be held responsible for any such errors and reserves the right to change the contents of this document without prior notice.