

2MP Fixed IR Bullet Analog Camera UAC-B112-F28(40)-X

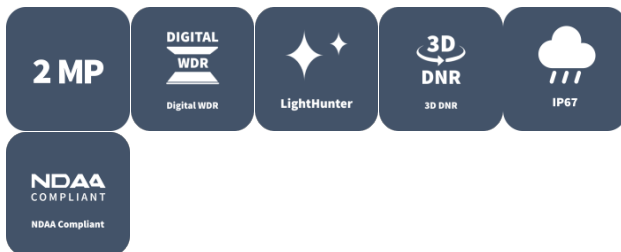

Overview

UAC-B112-F28(40)-X is a 2MP Fixed IR Bullet Analog Camera with a high-performance 1/3-inch CMOS sensor. It supports TVI/AHD/CVI/CVBS, which effectively enhances product adaptability and diversity of networking solutions. With SYV-75-3 or other coaxial cable types the camera can achieve low-cost, long-distance, anti-interference, and low delay mega-pixel video transmission. The camera supports IR cut filter and provides color images at daytime and black/white images at night.

Features

- 2MP high quality image
- TVI/AHD/CVI/CVBS
- IR-cut filter with auto switch (ICR)
- Supports 180° horizontal flip, 180° vertical flip
- OSD configuration menu, easy to operate
- IP67 waterproof and dustproof design, high reliability
- OSD configuration menu in 11 languages
- 3D noise reduction technology delivers clean and sharp images

Specifications





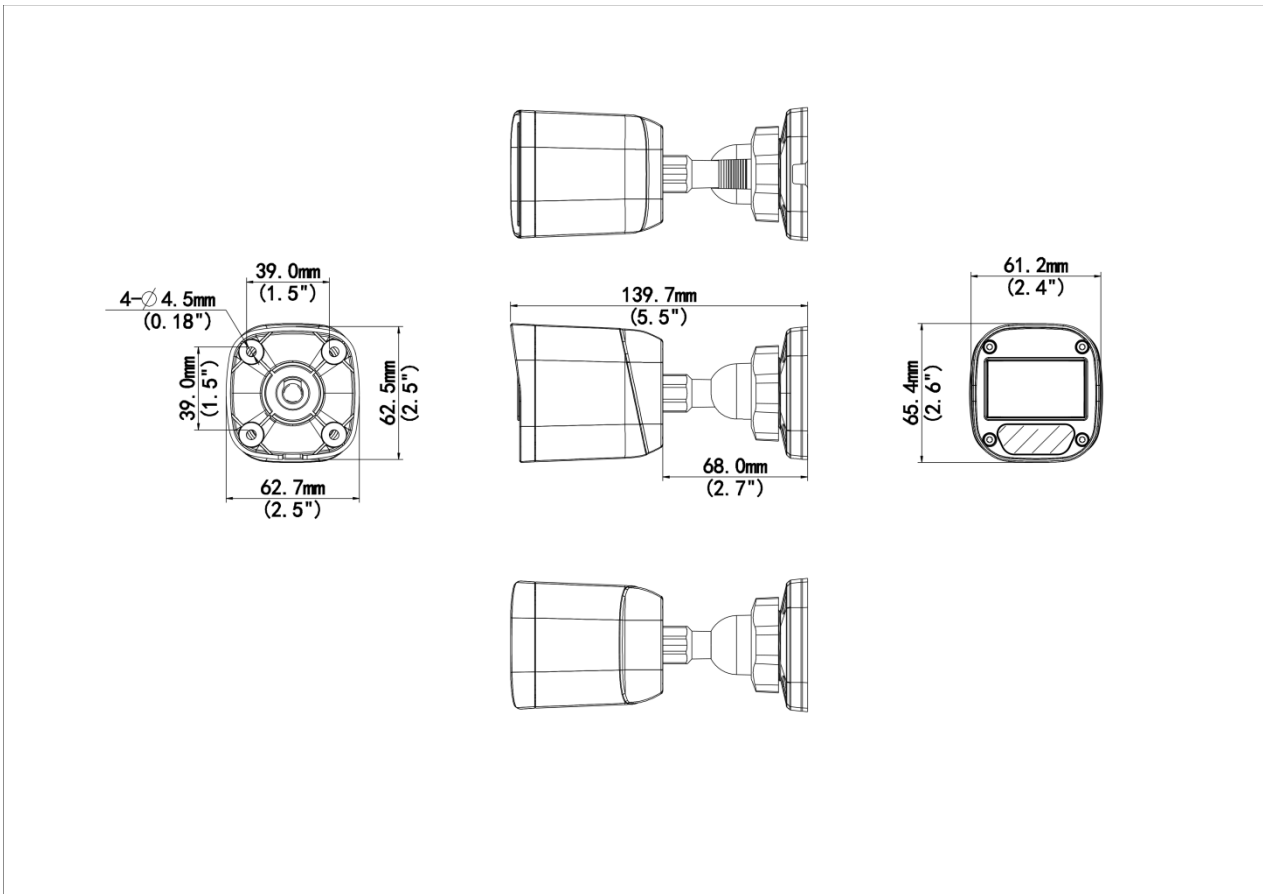

Model	UAC-B112-F28-X	UAC-B112-F40-X
Camera		
Max Resolution	2 MP	
Sensor Size	1/3.0" CMOS	
Min. Illumination	0.02 lux (F2.0, AGC ON) 0 lux (IR on)	
Lens		
Focus	2.8 mm	4.0 mm
Lens Mount	M12	
Angle of View (H)	90.5°	80.2°
Angle of View (V)	49.6°	40.7°
Angle of View (D)	109.5°	90.5°
Illuminator		
Illuminator Number	One IR illuminator	
Illumination Distance	20m	
Lifetime	≥ 60000 hours	
Video		
Resolution	1080P: 1920(H)×1080(V) 720P: 1280(H) ×720(V)	
Frame Rate	TVI: 1080P@25fps (default), 1080P@30fps; 720P@25fps, 720P@30fps AHD: 1080P@25fps, 1080P@30fps; 720P@25fps, 720P@30fps CVI: 1080P@25fps, 1080P@30fps; 720P@25fps, 720P@30fps CVBS: PAL, NTSC	
Shutter Time	PAL: 1/25 s-1/50000 s, NTSC: 1/30 s-1/50000 s	
Image		
Exposure Mode	Four modes: Global (default), BLC, HLC, DWDR	
Day/Night	Three modes: Auto (default), Day, Night	
Digital Noise Reduction	2D/3D	
White Balance	Two modes: Auto (default), Manual	
WDR	DWDR	
Smart IR	Support	
Flip	Supports 180°horizontal flip, 180°vertical flip	
Interface		
Power Interface	5.5 mm Power Interface	
Video Output	BNC, supports TVI/AHD/CVI/CVBS	
Operating Environment		
Temperature	-30 °C to 60 °C (-22 °F to 140 °F)	
Humidity	≤ 95% RH (non-condensing)	
Surge Protection	4 KV for power, 4 KV for video output interfaces	
General		
Power	DC 12 V±25%	

Power Consumption	MAX 2.0W	
Mount	Corner Mount, Pole Mount	
Dimensions	139.7mm*62.7mm*65.4mm (L*W*H)	142mm*63mm*65mm (L*W*H)
Material	Plastic	
Weight	145g(0.32lb)	
OSD Menu Language	11 Languages: English, German, Spanish (Latin America), French, Italian, Japanese, Korean, Polish, Portuguese (Brazil), Russian, Turkish	
Certification		
EMC	CE-EMC (EN 55032, EN 61000-3-3, EN IEC 61000-3-2, EN 55035), FCC (FCC 47 CFR part15 B)	
Safety	CE-LVD (EN 62368-1)	
Environment	CE-RoHS (2011/65/EU; (EU) 2015/863); WEEE (2012/19/EU)	
Protection	IP67 (IEC 60529)	

Dimensions



Accessories

<p>TR-JB05-A-IN Small Bullet Junction Box(Support wiring from behind,Square)</p>	<p>TR-UP06-B-IN Bullet Pole Mounting Bracket</p>	<p>TR-A01-IN NPT 3/4" Waterproof Cable Gland</p>
		
<p>TR-UP06-C-IN-V2 Pole Mounting Bracket for Bullet Junction Box Only</p>	<p>TR-UC08-C-V2 Bullet&Dome Corner Mounting Bracket</p>	<p>PWR-DC1201A-UK DC12V/1A Wall Plug British Standard Power Adapter</p>
		
<p>PWR-DC1201B-UK UNV DC12V/1A Wall Plug British Standard Power Adapter(Colorful Bag)</p>	<p>PWR-DC1201A-US DC12V/1A Wall Plug American Standard Power Adapter</p>	<p>PWR-DC1201B-US UNV DC12V/1A Wall Plug American Standard Power Adapter(Colorful Bag)</p>
		
<p>PWR-DC1201A-EU DC12V/1A Wall Plug European Standard Power Adapter</p>	<p>PWR-DC1201B-EU UNV DC12V/1A Wall Plug European Standard Power Adapter(Colorful Bag)</p>	<p>PWR-DC1201A-IND UNV DC12V/1A Wall Plug Indian Standard Power Adapter-Colorful Bag</p>
		

Unlimited New View

Zhejiang Uniview Technologies Co., Ltd.



<http://www.uniview.com>



overseasbusiness@uniview.com; globalsupport@uniview.com



No. 369, Xietong Road, Xixing Sub-district, Binjiang District, Hangzhou City, 310051, Zhejiang Province, China



©2023-2025 Zhejiang Uniview Technologies Co., Ltd. All rights reserved.

*Product specifications and availability are subject to change without notice.

Despite our best efforts, technical or typographical errors may exist in this document. Uniview cannot be held responsible for any such errors and reserves the right to change the contents of this document without prior notice.