

# 2MP Fixed Two-way Audio & Active Deterrence Dual-light Turret Analog Camera

## UAC-T142-ACF28(40)LM-DL



<b>2 MP</b>	<b>DIGITAL WDR</b> Digital WDR	<b>24 Color</b> ColorHunter	<b>IR</b> Dual-light	<b>3D DNR</b> 3D DNR
<b>Built-in mic</b>	<b>Two-way audio</b>	<b>IP67</b>	<b>NDA COMPLIANT</b> NDA Compliant	

## Overview

UAC-T142-ACF28(40)LM-DL is a 2MP ColorHunter with active deterrence dual-light turret analog camera with a high-performance 1/3-inch CMOS sensor and 3D noise reduction technology. It supports TVI/AHD/CVI/CVBS, which effectively enhances product adaptability and diversity of networking solutions. With SYV-75-3 or other coaxial cable types, the camera can achieve low-cost, long-distance, and anti-interference mega-pixel HD video transmission without time delay. The ColorHunter camera is equipped with two-way audio communication and strobe light alarm capabilities. Pairing with the Q4-series XVR, the camera allows for real-time communication while actively deterring intruders with lights and alarms when unattended. The system provides real-time alerts to users through coaxial cables, offering a safer living environment.

## Features

Note: To use the two-way audio & active deterrence dual-light analog camera, make sure it is used with our XVR301-04Q4/XVR301-08Q4/XVR301-16Q4, and the XVR must be upgraded to the latest version.

- High quality imaging with 2MP resolution
- TVI/AHD/CVI/CVBS
- Supports IR-cut filter with auto-switch (ICR)
- Two-way audio (Only TVI 1080P)
- Dual-light active deterrence (only TVI)
- Active defense with visual and auditory warnings (Only TVI 1080P)
- High-quality audio through coaxial cables, built-in microphone, and built-in speaker
- 3D noise reduction technology delivers clean and sharp images

- Supports 180° horizontal flip, 180° vertical flip
- OSD configuration menu, easy to operate
- IP67 waterproof and dustproof design, high reliability
- OSD configuration menu in 11 languages

## Specifications





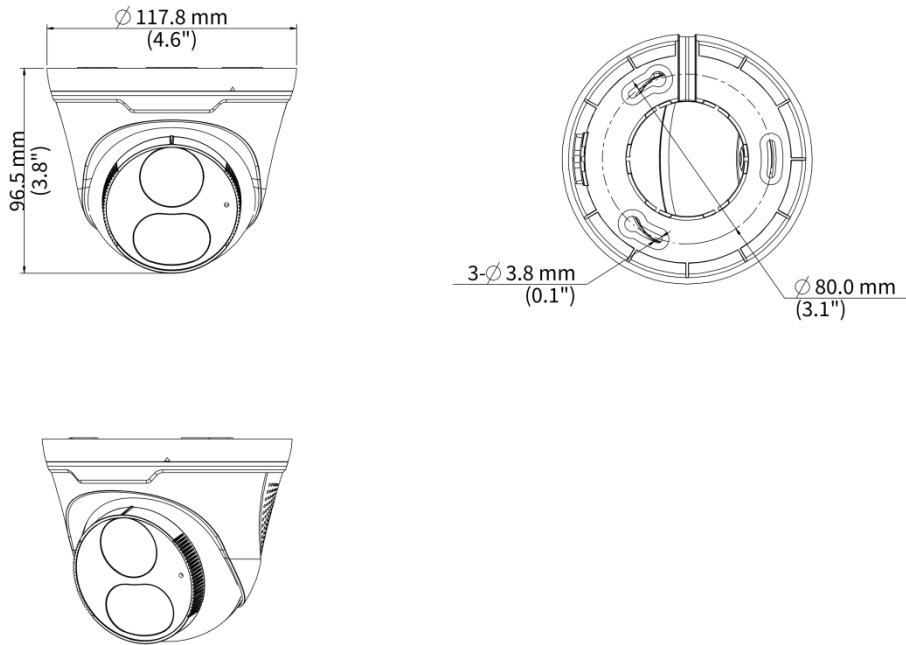

Model	UAC-T142-ACF28LM-DL	UAC-T142-ACF40LM-DL
<b>Camera</b>		
Max Resolution	2 MP	
Sensor Size	1/3.0" CMOS	
Min. Illumination	0.003 lux (F1.6, AGC ON) 0 lux (Illuminator ON)	
<b>Lens</b>		
Focus	2.8 mm	4.0 mm
Lens Mount	M12	
Angle of View (H)	96.5°	52.0°
Angle of View (V)	54.5°	31.0°
Angle of View (D)	109.5°	59.0°
<b>Illuminator</b>		
Illuminator Number	One IR illuminator; One white-light illuminator	
Illumination Distance	IR: 40m (131.23 ft) White light: 40m (131.23ft)	
Lifetime	≥ 60000 hours	
<b>Video</b>		
Resolution	1080P: 1920(H)×1080(V) 720P: 1280(H) ×720(V)	
Frame Rate	TVI: 1080P@25fps (default), 1080P@30fps; 720P@25fps, 720P@30fps AHD: 1080P@25fps, 1080P@30fps; 720P@25fps, 720P@30fps CVI: 1080P@25fps, 1080P@30fps; 720P@25fps, 720P@30fps CVBS: PAL, NTSC	
Shutter Time	PAL: 1/25 s-1/50000 s, NTSC: 1/30 s-1/50000 s	
<b>Image</b>		
Exposure Mode	Four modes: Global (default), BLC, HLC, DWDR	
Day/Night	Three modes: Auto (default), Day, Night	
Digital Noise Reduction	2D/3D	
White Balance	Two modes: Auto (default), Manual	
WDR	DWDR	
Light Mode	Dual light (default) , Infrared, White light	
Flip	Supports 180°horizontal flip, 180°vertical flip	
Digital Defog	N/A	
<b>Audio</b>		
Built-in Mic	Support	
Camera Audio	TVI: 1080P@25fps, 1080P@30fps	







	CVI: 1080P@25fps, 1080P@30fps
Two-way Audio	Support
<b>Interface</b>	
Power Interface	5.5 mm Power Interface
Video Output	BNC, supports TVI/AHD/CVI/CVBS
<b>Operating Environment</b>	
Temperature	-30 °C to 60 °C (-22 °F to 140 °F)
Humidity	≤ 95% RH (non-condensing)
Surge Protection	4 KV for power, 4 KV for video output interfaces
<b>General</b>	
Power	DC 12 V±25%
Power Consumption	MAX 3.4W
Mount	Corner Mount, Pole Mount, Wall Mount, Pendant Mount
Dimensions	Φ117.8mm*96.5mm (diameter*height)
Material	Metal + Plastic
Weight	256g(0.57lb)
OSD Menu Language	11 Languages: English, German, Spanish (Latin America), French, Italian, Japanese, Korean, Polish, Portuguese (Brazil), Russian, Turkish
<b>Certification</b>	
EMC	CE-EMC (EN 55032, EN 61000-3-3, EN IEC 61000-3-2, EN 50130-4), FCC (FCC 47 CFR part15 B)
Safety	CE-LVD (EN IEC 62368-1)
Environment	CE-RoHS (2011/65/EU; (EU) 2015/863); WEEE (2012/19/EU)
Protection	IP67 (IEC 60529)

## Dimensions



## Accessories

<p><b>TR-JB03-I-IN</b> Junction Box for Turret Camera(Support wiring from behind)</p>	<p><b>TR-WM07P-B</b> Dome Wall Mounting Plastic Bracket</p>	<p><b>TR-A01-IN</b> NPT 3/4" Waterproof Cable Gland</p>
		
<p><b>TR-SE24-A-IN</b> Dome Pendant Mounting Pole 500mm</p>	<p><b>TR-CM24-IN</b> Dome Pendant Mounting Bracket(Indoor)</p>	<p><b>TR-SE24-IN</b> Dome Pendant Mounting Pole 200mm</p>
		

<p><b>TR-JB07/WM03-G-IN-V2</b> Wall Mounting Assembling Bracket For 32 Fix-dome&amp;Mini Fix-dome&amp;Plastic Turret Camera</p>	<p><b>TR-WM03-D-IN-V2</b> Wall Mounting Bracket for 32 Fix-dome&amp;Mini Fix-dome&amp;Plastic Turret Camera</p>	<p><b>TR-UC08-C-V2</b> Bullet&amp;Dome Corner Mounting Bracket</p>
		
<p><b>TR-UP06-C-IN-V2</b> Pole Mounting Bracket for Bullet Junction Box Only</p>	<p><b>PWR-DC1201A-UK</b> DC12V/1A Wall Plug British Standard Power Adapter</p>	<p><b>PWR-DC1201B-UK</b> UNV DC12V/1A Wall Plug British Standard Power Adapter(Colorful Bag)</p>
		
<p><b>PWR-DC1201A-US</b> DC12V/1A Wall Plug American Standard Power Adapter</p>	<p><b>PWR-DC1201B-US</b> UNV DC12V/1A Wall Plug American Standard Power Adapter(Colorful Bag)</p>	<p><b>PWR-DC1201A-EU</b> DC12V/1A Wall Plug European Standard Power Adapter</p>
		
<p><b>PWR-DC1201B-EU</b> UNV DC12V/1A Wall Plug European Standard Power Adapter(Colorful Bag)</p>	<p><b>PWR-DC1201A-IND</b> UNV DC12V/1A Wall Plug Indian Standard Power Adapter-Colorful Bag</p>	
		

# Unlimited New View

## Zhejiang Uniview Technologies Co., Ltd.



<http://www.uniview.com>



[overseasbusiness@uniview.com](mailto:overseasbusiness@uniview.com); [globalsupport@uniview.com](mailto:globalsupport@uniview.com)



No. 369, Xietong Road, Xixing Sub-district, Binjiang District, Hangzhou City, 310051, Zhejiang Province, China



©2023-2025 Zhejiang Uniview Technologies Co., Ltd. All rights reserved.

\*Product specifications and availability are subject to change without notice.

Despite our best efforts, technical or typographical errors may exist in this document. Uniview cannot be held responsible for any such errors and reserves the right to change the contents of this document without prior notice.