

# 4MP 42X Wise-ISP IR Wiper Network PTZ Camera IPC6824ER-X42-W-VH2



## Features

- 2688 × 1520@60 fps in the main stream
- 42X optical zoom
- Smart intrusion prevention, supports false alarm filtering, including cross line, intrusion, enter area, leave area detection
- Supports front end, supports blocklist and allowlist comparison
- People counting, supports people flow counting and crowd density monitoring
- Supports optical defog, self adaptive defog
- Wise-ISP technology ensures ultra high image quality in low illumination environment
- IR illumination: 500 m (1640 ft) distance, proportional to optical zoom of camera module
- Gyroscope stabilization for stable picture
- Supports wiper
- Power supply: DC 24 V±25%, AC 24 V±25%, PoE (IEEE802.3bt)
- Alarm I/O: 7/2, audio I/O: 1/1
- IP67 ingress protection

## Specifications

Model	IPC6824ER-X42-W-VH2
<b>Camera</b>	
Sensor	1/1.8" CMOS
Min. Illumination	Color: 0.0003 Lux (F1.2, AGC ON), 0 Lux with IR
Day/Night	IR-cut filter with auto switch (ICR)
Shutter	Auto/Manual, 1 to 1/100000 s
WDR	150 dB
S/N	> 56 dB
<b>Lens</b>	
Focal Length	6 to 252 mm
Optical Zoom	42X
Digital Zoom	8X
Iris	F1.2 to F4.6
Field of View (H)	59.47° (W) to 2.20° (T)
Field of View (V)	35.62° (W) to 1.24° (T)
Field of View (D)	73.14° (W) to 2.59° (T)
<b>DORI</b>	
DORI Distance (Detect)	93.1 m to 4310.3 m (305.5 ft. to 14143.7 ft.)
DORI Distance (Observe)	37.2 m to 1564.1 m (122.1 ft. to 6116.1 ft.)
DORI Distance (Recognize)	18.6 m to 782.1 m (61.0 ft. to 2894.1 ft.)
DORI Distance (Identify)	9.3 m to 391.0 m (30.5 ft. to 1610.6 ft.)
<b>Video</b>	
Video Compression	H.265, H.264, MJPEG, Ultra 265
Frame Rate	Main Stream: 4 MP (2688 × 1520), max. 60 fps Sub Stream: 1080P (1920 × 1080), max. 60 fps Third Stream: D1 (720 × 576), max. 60 fps
Video Bit Rate	128 Kbps to 16 Mbps
U-code	Support
ROI	Up to 8 areas
Video Stream	Triple streams
Privacy Mask	24 areas, up to 8 areas per scene
OSD	Up to 10 OSDs
<b>Events</b>	
Basic Detection	Motion detection, Ultra motion detection, Tampering alarm, Audio detection, Object removed, Object Left Behind
General Function	Watermark, IP address filtering, Access policy, ARP protection, RTSP authentication, User authentication, Alarm input, Alarm output
<b>Audio</b>	
Audio Bitrate	128 Kbps
Two-way Audio	Support
Suppression	Support





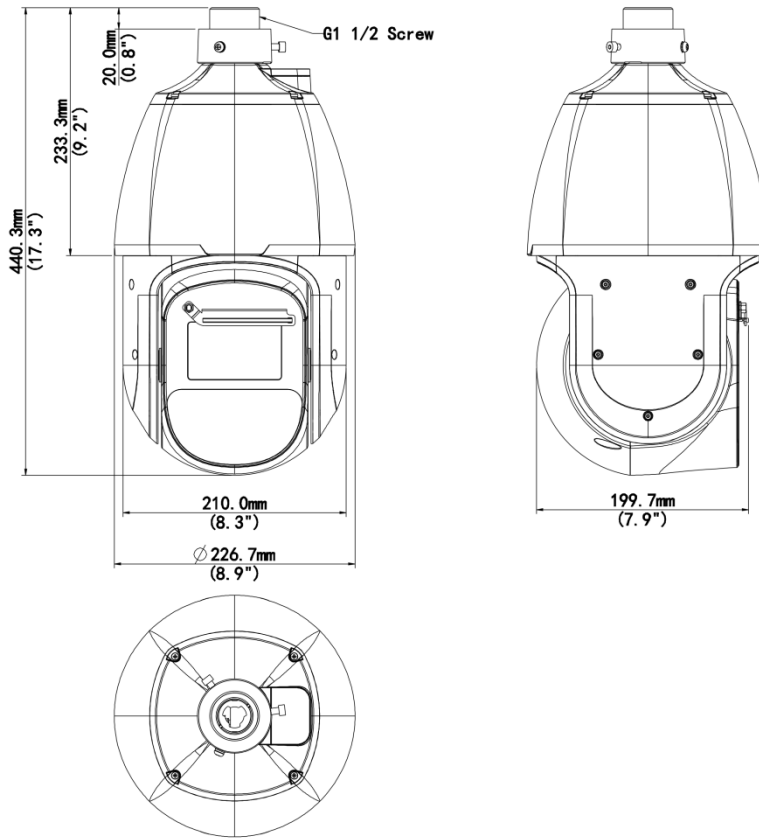

Audio Compression	G.711U, G.711A
Sampling Rate	8 kHz, 16 kHz
<b>Storage</b>	
Edge Storage	MicroSD, up to 512 GB
Network Storage	ANR, NAS (NFS)
<b>Network</b>	
User/Host	Up to 32 users. 3 user levels: administrator, common user and operator
Protocols	SSH, IGMP, RTP, RTCP, SMTP, IPv4, IPv6, ICMP, ARP, TCP, UDP, DHCP, PPPoE, RTSP, RTMP, DNS, DDNS, NTP, UPnP, HTTP, HTTPS, 802.1x, SNMP, QoS, SSL/TLS, FTP
Compatible Integration	ONVIF (Profile S, Profile G, Profile T, Profile M), SDK, API
Security	Strong Password, Basic and Digest Authentication for RTSP, Digest Authentication for HTTP, TLS 1.2, TLS 1.3, WSSE and Digest Authentication for ONVIF, Password protection, HTTPS encryption, Export operation logs
Client	EZStation, UNV-Link, UNV-Link Pro
Web Browser	Plug-in required live view: IE 10+, Chrome 45+, Firefox 52+, Edge 79+
<b>Intelligent</b>	
Auto Tracking	Support, target filtering: human, non-motor vehicle and vehicle
Multi-target Detection	N/A
People Counting	Support people flow counting and crowd density detection
Smart Intrusion Prevention	Cross line detection, intrusion detection, enter area detection, leave area detection (support false alarm filtering and the classification of human, non-motor vehicle and vehicle)
Recognition	Face Recognition: Max support 16 face libraries, Max supports 100000 faces in face library
<b>PTZ</b>	
Route Patrol	16 patrols, up to 32 actions for each patrol
Recorded Patrol	16 patrols, up to 128 actions for each patrol
Preset Image Freeze	Support
Preset Patrol	16 patrols, up to 64 presets for each patrol
Patrol Stay Time	15 s to 1800 s
Home Position	Support
Tilt Range	-15° to 90° (Upward tilt is negative)
Pan Speed	0.1°/s to 300°/s
Pan Range	0° to 360° (endless)
3D Positioning	Support
Tilt Speed	0.1°/s to 180°/s
Number of Presets	1024
<b>Image</b>	
BLC	Support
White Balance	Auto, Outdoor, Fine tune, Sodium lamp, Locked, Auto2, Area white balance
Digital Noise Reduction	2D/3D DNR
Flip	Normal, Flip horizontal, Flip vertical, 180°
HLC	Support
Defog	Digital defog, Optical defog
Image Stabilization	EIS (Gyroscope)





Interface	
Audio I/O	1 Input: impedance 1 k $\Omega$ , amplitude 2.5 V [p-p], 1 Output: impedance 600 $\Omega$ , amplitude 2.5 V [p-p]
Alarm I/O	7/2
Network	1 $\times$ RJ45 10 M/100 M Base-TX Ethernet
Serial Port	1 $\times$ RS485
Video Output	1 BNC
Illuminator	
Wavelength	850 nm
IR On/Off Control	Auto/Manual
Illumination Distance (IR)	500 m (1640.4 ft.)
Certification	
Safety	CE LVD (EN IEC 62368-1+ A11) UL (UL 62368-1) CUL (CAN/CSA C22.2 No. 62368-1)
EMC	CE-EMC (EN 55032; EN IEC 61000-3-2; EN 61000-3-3; EN 50130) FCC SDoC (47 CFR Part 15; Subpart B)
Environment	CE ROHS (2011/65/EU; (EU)2015/863)
Protection	IP67 (IEC 60529+ AMD1+ AMD2) IK10 (IEC 62262, Anti-Vandalism Except for the Front Window)
General	
Power	DC 24 V $\pm$ 25%, AC 24 V $\pm$ 25%, PoE (IEEE802.3bt)
Power Consumption	$\leq$ 65.5W
Power Interface	Wires with cold-pressed terminal
Dimensions	$\varnothing$ 227 mm $\times$ 414 mm ( $\varnothing$ 8.94" $\times$ 16.30") ( $\varnothing$ $\times$ H)
Weight	6.9 kg
Storage Environment	-40 $^{\circ}$ C to 70 $^{\circ}$ C (-40 $^{\circ}$ F to 158 $^{\circ}$ F), Humidity: $\leq$ 95% RH (non-condensing)
Surge Protection	6 KV
Reset Button	Support
Working Environment	-40 $^{\circ}$ C to 70 $^{\circ}$ C (-40 $^{\circ}$ F to 158 $^{\circ}$ F), Humidity: $\leq$ 95% RH (non-condensing)
Heater	Support
Compliance	
NDAA Compliant	Support

# Dimensions



# Accessories

TR-UF45-A-IN	TR-SE45-A-IN	TR-UC08-B-IN
Dome Indoor Ceiling Mounting Pedestal	Dome Ceiling Mounting Pole 500	Aluminium Alloy Corner Mounting Bracket
		
TR-UC08-A-IN	TR-UP08-B-IN	TR-UP08-A-IN
Dome Corner Mounting Bracket	Aluminium Alloy Pole Mounting Bracket	Dome Pole Mounting Bracket
		

<p><b>TR-WE45-B-IN</b> Dome Gooseneck Bracket</p>	<p><b>TR-JB12-IN</b> Dome Junction Box</p>	<p><b>TR-CE45-IN</b> Dome Indoor Ceiling Mounting Bracket</p>
		
<p><b>TR-WE45-A-IN</b> Long Wall Mounting Bracket for Dome</p>	<p><b>TR-SE45-IN</b> Dome Ceiling Mounting Pole 200</p>	
		

# Unlimited New View

## Zhejiang Uniview Technologies Co., Ltd.



<http://www.uniview.com>



[overseasbusiness@uniview.com](mailto:overseasbusiness@uniview.com); [globalsupport@uniview.com](mailto:globalsupport@uniview.com)



No. 369, Xietong Road, Xixing Sub-district, Binjiang District, Hangzhou City, 310051, Zhejiang Province, China



©2023-2025 Zhejiang Uniview Technologies Co., Ltd. All rights reserved.

\*Product specifications and availability are subject to change without notice.

Despite our best efforts, technical or typographical errors may exist in this document. Uniview cannot be held responsible for any such errors and reserves the right to change the contents of this document without prior notice.