

2MP HD 4G ColorHunter Fixed Bullet Network Camera IPC2A12LP-ADF40(60)KC-4G-JP

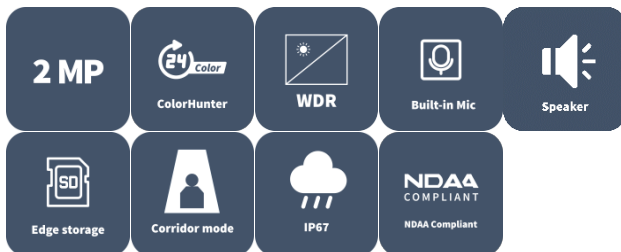

Features

- High quality image with 1080P, 1/2.8" CMOS sensor
- 1080P (1920 × 1080), max. 30 fps; 720P (1280 × 720), max. 30 fps
- Supports 4G access to the network
- Alarm I/O: 1/1
- Audio I/O: 1/1
- Built-in mic and speaker
- Smart IR, up to 50 m (164.0 ft.) IR distance
- White light, up to 30 m (98.4 ft.) white light distance
- MicroSD, up to 512 GB
- IP67 protection

Specifications

Model	IPC2A12LP-ADF40KC-4G-JP	IPC2A12LP-ADF60KC-4G-JP
Camera		
Max Resolution	2 MP	
Sensor	1/2.8" CMOS	
Min. Illumination	Color: 0.005 Lux (F1.6, AGC ON), 0 Lux with light	
Day/Night	IR-cut filter with auto switch (ICR)	
Shutter	Auto/Manual, 1 ~ 1/100000s	
S/N	>52 dB	
WDR	120 dB	
Lens		
Focal Length	4.0 mm	6.0 mm
Iris Type	Fixed	
Iris	F1.6	
Field of View (H)	87.5°	54.2°
Field of View (V)	46.3°	28.9°
Field of View (D)	92.4°	61.5°
DORI		
DORI Distance (Lens)	4 mm	6 mm
DORI Distance (Detect)	62.1 m (203.7 ft.)	93.1 m (305.5 ft.)
DORI Distance (Observe)	24.8 m (81.4 ft.)	37.2 m (122.1 ft.)
DORI Distance (Recognize)	12.4 m (40.7 ft.)	18.6 m (61.0 ft.)
DORI Distance (Identify)	6.2 m (20.3 ft.)	9.3 m (30.5 ft.)
Illuminator		
Illumination Distance (Warm Light)	30 m (98.4 ft.)	
Illumination Distance (IR)	50 m (164.0 ft.)	
Wavelength	850 nm	
IR On/Off Control	Auto/Manual	
Video		
Video Compression	Ultra 265, H.265, H.264, MJPEG	
H.264 Code Profile	Baseline profile, Main profile, High profile	
Frame Rate	Main Stream: 1080P (1920 × 1080), max. 30 fps; 720P (1280 × 720), max. 30 fps Sub Stream: 720P (1280 × 720), max. 30 fps; D1 (720 × 576), max. 30 fps; 640 × 360, max. 30 fps;	
Video Bit Rate	128 Kbps to 2048 Kbps	
U-code	Support	
OSD	Up to 8 OSDs	
Privacy Mask	Up to 4 areas	
ROI	Up to 8 areas	
Video Stream	Dual streams	
Image		
White Balance	Auto, Outdoor, Fine tune, Sodium lamp, Locked, Auto2	



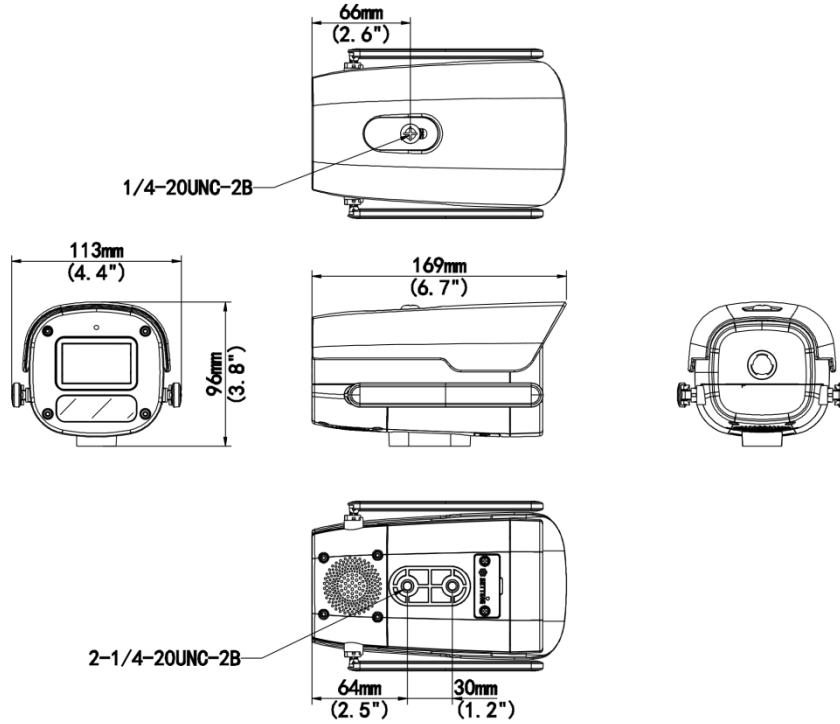

Digital Noise Reduction	2D/3D DNR
Smart IR	Support
Flip	Normal, Flip vertical, Flip horizontal, 180°, 90° Clockwise, 90° Anti-clockwise
Dewarping	N/A
HLC	Support
BLC	Support
Defog	Digital defog
Intelligent	
Smart Intrusion Prevention	Cross line detection, intrusion detection, enter area detection, leave area detection (support false alarm filtering and the classification of human, non-motor vehicle and vehicle)
Events	
Basic Detection	Motion detection, Ultra motion detection, Tampering alarm, Audio detection
General Function	Watermark, IP address filtering, Access policy, ARP protection, RTSP authentication, User authentication
Audio	
Audio Compression	G.711U, G.711A
Audio Bitrate	64 Kbps
Two-way Audio	Support
Suppression	Support
Sampling Rate	8 kHz
Network	
4G Network Frequency	LTE-TDD: Band 41 LTE-FDD: Band 1/3/8/18/19/26 UMTS: Band 1/6/8/19
4G Network Standard	LTE-TDD, LTE-FDD, UMTS
4G Card Type	Nano-SIM
Protocols	IPv4, IPv6, IGMP, ICMP, ARP, TCP, UDP, DHCP, PPPoE, RTP, RTSP, RTCP, RTMP, DNS, DDNS, NTP, FTP, UPnP, HTTP, HTTPS, QoS, SMTP, 802.1x, SSL/TLS, SNMP
Compatible Integration	ONVIF (Profile S, Profile G, Profile T), API, SDK
User/Host	Up to 32 users. 3 user levels: administrator, common user and operator
Security	Password Protection, Strong Password, HTTPS Encryption, Export Operation Logs, Basic and Digest Authentication for RTSP, Digest Authentication for HTTP, TLS 1.2, WSSE and Digest Authentication for ONVIF
Client	EZStation, APP
Web Browser	Plug-in required live view: IE 10+, Chrome 45+, Firefox 52+, Edge 79+, Plug-in free live view: Chrome 57+, Firefox 58+, Edge 16+
Storage	
Edge Storage	MicroSD, up to 512 GB
Network Storage	ANR NAS (NFS)
Interface	
Audio I/O	1 Input: impedance 35 kΩ, amplitude 2 V [p-p], 1 Output: impedance 600 Ω, amplitude 2 V [p-p]
Alarm I/O	1/1
Serial Port	N/A

Built-in Mic	Support
Built-in Speaker	Support
WIFI	N/A
Network	1 × RJ45 10 M/100 M Base-TX Ethernet
Video Output	N/A
Certification	
Protection	IP67 (IEC 60529)
General	
Power	DC 12 V±25% Power consumption: Max. 6.9 W
Power Interface	Ø5.5 mm coaxial power plug
Dimensions	169 mm × 113 mm × 96 mm (6.7" × 4.4" × 3.8") (L × W × H)
Weight	0.47 kg (1.04 lb.)
Material	Graphene + Metal
Working Environment	-30 °C to 60 °C (-22 °F to 140 °F), Humidity: ≤ 95% RH (non-condensing)
Storage Environment	-30 °C to 60 °C (-22 °F to 140 °F), Humidity: ≤ 95% RH (non-condensing)
Surge Protection	4 KV
Reset Button	Support
Web Client Language	20 Languages: Traditional Chinese, English, Simplified Chinese, Polish, German, Russian, French, Korean, Dutch, Czech, Portuguese (Europe), Portuguese (Brazil), Japanese, Thai, Turkish, Spanish (Latin America), Spanish (Europe), Hungarian, Italian, Vietnamese

Dimensions

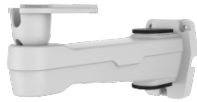

Accessories

<p>TR-WM06-C-IN Wall Mounting Bracket for 6-inch Bullet Camera</p>	<p>TR-UP06-B-IN Bullet Pole Mounting Bracket</p>	<p>TR-WM07P-A Bullet Wall Mounting Plastic Bracket</p>
		
<p>TR-UM06-A-IN Bullet Camera Desktop Bracket</p>	<p>TR-CM08P-A Bullet Pendant Mounting Plastic Bracket</p>	
		

Unlimited New View

Zhejiang Uniview Technologies Co., Ltd.

 <http://www.uniview.com>

 overseasbusiness@uniview.com; globalsupport@uniview.com

 No. 369, Xietong Road, Xixing Sub-district, Binjiang District, Hangzhou City, 310051, Zhejiang Province, China



©2023-2025 Zhejiang Uniview Technologies Co., Ltd. All rights reserved.

*Product specifications and availability are subject to change without notice.

Despite our best efforts, technical or typographical errors may exist in this document. Uniview cannot be held responsible for any such errors and reserves the right to change the contents of this document without prior notice.