

4MP Fixed IR Turret Network Camera IPC3614LB-AF28K-A2



Features

- High quality image with 4 MP, 1/3.0" CMOS sensor
- 4 MP (2560 × 1440)@25/20 fps; 3 MP (2304 × 1296)@30/25 fps; 1080P (1920 × 1080)@30/25 fps
- Supports accurate human body detection 2.0
- Ultra 265, H.265, H.264
- Built-in mic
- Smart IR, up to 30 m (98.4 ft.) IR distance
- Day/night functionality
- 2D/3D DNR (digital noise reduction)
- MicroSD, up to 512 GB
- DC 12 V, PoE (IEEE 802.3af) power supply
- IP67 protection
- 3-axis

Specifications

| Model | IPC3614LB-AF28K-A2 |
|----------------------------|--|
| Camera | |
| Max Resolution | 4 MP |
| Sensor | 1/3.0" CMOS |
| Min. Illumination | Color: 0.01 Lux (F2.0, AGC ON), 0 Lux with IR on |
| Day/Night | IR-cut filter with auto switch (ICR) |
| Shutter | Auto/Manual, 1 to 1/100000 s |
| Adjustment Angle | Pan: 0° to 360°, Tilt: 0° to 80°, Rotate: 0° to 360° |
| S/N | > 52 dB |
| WDR | DWDR |
| Lens | |
| Focal Length | 2.8 mm |
| Iris | F2.0 |
| Field of View (H) | 94.3° |
| Field of View (V) | 52.2° |
| Field of View (D) | 99.6° |
| Lens Type | Fixed |
| Iris Type | Fixed |
| DORI | |
| DORI Distance (Lens) | 2.8 mm |
| DORI Distance (Detect) | 63.0 m (206.7 ft.) |
| DORI Distance (Observe) | 25.2 m (82.7 ft.) |
| DORI Distance (Recognize) | 12.6 m (41.3 ft.) |
| DORI Distance (Identify) | 6.3 m (20.7 ft.) |
| Illuminator | |
| Supplemental Light | IR |
| Illumination Distance (IR) | 30 m (98.4 ft.) |
| Wavelength | 850 nm |
| IR On/Off Control | Auto/Manual |
| Video | |
| Video Compression | Ultra 265, H.265, H.264 |
| H.264 Code Profile | Baseline profile, Main profile, High profile |
| Frame Rate | Main Stream: 4 MP (2560 × 1440), max. 25 fps; 3 MP (2304 × 1296), max. 30 fps; 1080P (1920 × 1080), max. 30 fps; Sub Stream: D1 (720 × 576), max. 30 fps; 640 × 360, max. 30 fps; 2CIF (704 × 288), max. 30 fps; CIF (352 × 288), max. 30 fps |
| Video Bit Rate | 128 Kbps to 6144 Kbps |
| U-code | Support |
| OSD | Up to 4 OSDs |
| Privacy Mask | Up to 4 areas |
| ROI | Support |







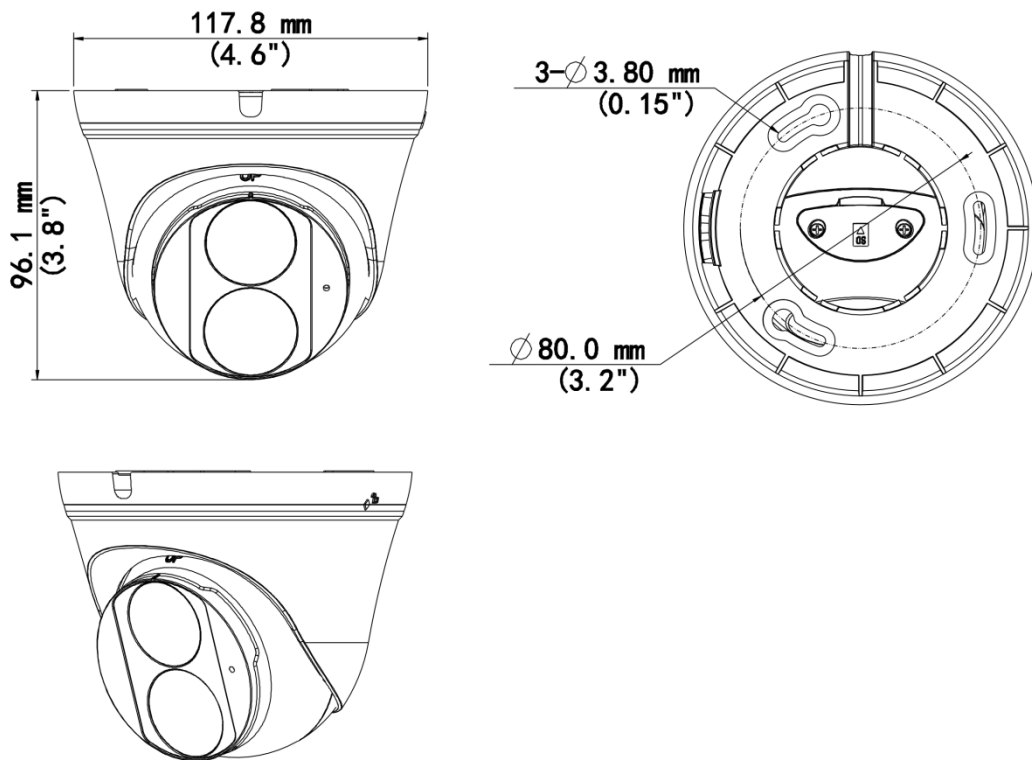

| | |
|-------------------------|--|
| Video Stream | Dual streams |
| Image | |
| White Balance | Auto, Outdoor, Fine tune, Sodium lamp, Locked, Auto2, Area white balance |
| Digital Noise Reduction | 2D/3D DNR |
| Smart IR | Support |
| Flip | Normal, Flip vertical, Flip horizontal, 180° |
| Dewarping | N/A |
| HLC | Support |
| BLC | Support |
| Defog | Digital defog |
| Image Stabilization | N/A |
| Events | |
| Basic Detection | Human body detection 2.0, Motion detection, Audio detection |
| General Function | Watermark, IP address filtering, Access policy, ARP protection, RTSP authentication, User authentication, HTTP authentication |
| Audio | |
| Audio Compression | G.711U, G.711A |
| Audio Bitrate | 64 Kbps |
| Two-way Audio | N/A |
| Suppression | Support |
| Sampling Rate | 8 kHz |
| Storage | |
| Edge Storage | MicroSD, up to 512 GB |
| Network | |
| Protocols | IPv4, IGMP, ICMP, ARP, TCP, UDP, DHCP, RTP, RTSP, RTCP, RTMP, DNS, DDNS, NTP, UPnP, HTTP, HTTPS, QoS, SSL/TLS |
| Compatible Integration | API, SDK |
| Client | EZStation, APP |
| Web Browser | Plug-in free live view: Chrome 57+, Firefox 58+, Edge 16+, Plug-in required live view: IE 10+, Chrome 45+, Firefox 52+, Edge 79+ |
| Security | Password Protection, Strong Password, HTTPS Encryption, Export Operation Logs, Basic and Digest Authentication for RTSP, Digest Authentication for HTTP, TLS 1.2, WSSE and Digest Authentication for ONVIF |
| User/Host | Up to 32 users. 3 user levels: administrator, common user and operator |
| Interface | |
| Audio I/O | N/A |
| Alarm I/O | N/A |
| Serial Port | N/A |
| Built-in Mic | Support |
| Built-in Speaker | N/A |
| WIFI | N/A |
| Network | 1 × RJ45 10 M/100 M Base-TX Ethernet |
| Video Output | N/A |

| Certification | |
|---------------------|--|
| EMC | CE-EMC (EN 55032, EN 61000-3-3, EN IEC 61000-3-2, EN 50130-4) FCC (FCC 47 CFR part15 B) |
| Protection | IP67 (IEC 60529) |
| Safety | CE-LVD (EN 62368-1) |
| Environment | CE-RoHS (2011/65/EU ; (EU) 2015/863) ; WEEE (2012/19/EU) |
| General | |
| Power | DC 12 V±25%, PoE (IEEE 802.3af) |
| Power Consumption | Max. 3.9 W |
| Power Interface | Ø5.5 mm coaxial power plug |
| Dimensions | Ø118 mm × 95 mm (Ø4.6" × 3.8") (Ø × H) |
| Weight | 0.25 kg (0.55 lb.) |
| Material | Graphene + Plastic |
| Storage Environment | -30 °C to 60 °C (-22 °F to 140 °F), Humidity: ≤ 95% RH (non-condensing) |
| Working Environment | -30 °C to 60 °C (-22 °F to 140 °F), Humidity: ≤ 95% RH (non-condensing) |
| Surge Protection | 4 KV |
| Reset Button | N/A |
| Web Client Language | 4 Languages: English, Russian, Spanish, Vietnamese |

Dimensions

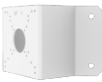

Accessories

| | | |
|---|---|---|
| <p>TR-JB03-I-IN Junction Box for Turret Camera(Support wiring from behind)</p> | <p>TR-CM24-IN Dome Pendant Mounting Bracket(Indoor)</p> | <p>TR-SE24-A-IN Dome Pendant Mounting Pole 500mm</p> |
|  |  |  |
| <p>TR-A01-IN NPT 3/4" Waterproof Cable Gland</p> | <p>TR-SE24-IN Dome Pendant Mounting Pole 200mm</p> | <p>TR-JB07/WM03-G-IN-V2 Wall Mounting Assembling Bracket For 32 Fix-dome&Mini Fix-dome&Plastic Turret Camera</p> |
|  |  |  |
| <p>TR-WM03-D-IN-V2 Wall Mounting Bracket for 32 Fix-dome&Mini Fix-dome&Plastic Turret Camera</p> | <p>TR-UC08-C-V2 Bullet&Dome Corner Mounting Bracket</p> | <p>TR-UP06-C-IN-V2 Pole Mounting Bracket for Bullet Junction Box Only</p> |
|  |  |  |
| <p>TR-WM07P-B Dome Wall Mounting Plastic Bracket</p> | | |
|  | | |

Unlimited New View

Zhejiang Uniview Technologies Co., Ltd.

 <http://www.uniview.com>

 overseasbusiness@uniview.com; globalsupport@uniview.com

 No. 369, Xietong Road, Xixing Sub-district, Binjiang District, Hangzhou City, 310051, Zhejiang Province, China



©2023-2025 Zhejiang Uniview Technologies Co., Ltd. All rights reserved.

*Product specifications and availability are subject to change without notice.

Despite our best efforts, technical or typographical errors may exist in this document. Uniview cannot be held responsible for any such errors and reserves the right to change the contents of this document without prior notice.