

# 4MP HD Smart Dual Light Fixed Turret Network Camera IPC3614LB-AF28K-DL2

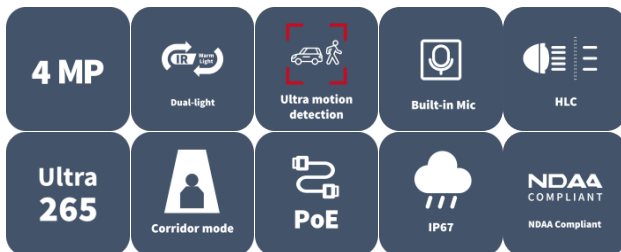

## Features

- High quality image with 4 MP, 1/3" CMOS sensor
- 4 MP (2560 × 1440)@25/20 fps; 3 MP (2304 × 1296)@30/25 fps; 1080P (1920 × 1080)@30/25 fps
- Smart dual-light ensures high quality image
- Ultra 265, H.265, H.264
- Supports ultra motion detection
- Built-in mic
- Up to 30 m (98.4 ft.) IR and warm light distance
- MicroSD, up to 512 GB
- IP67 protection
- 3-axis
- Supports PoE power supply
- Supports corridor mode

## Specifications

Model	IPC3614LB-AF28K-DL2
<b>Camera</b>	
Max Resolution	4 MP
Sensor	1/3.0" CMOS
Min. Illumination	Color: 0.01 Lux (F1.6, AGC ON), 0 Lux with light
Day/Night	IR-cut filter with auto switch (ICR)
Shutter	Auto/Manual, 1 ~ 1/100000s
Adjustment Angle	Pan: 0° to 360°, Tilt: 0° to 80°, Rotate: 0° to 360°
S/N	>52 dB
WDR	DWDR
<b>Lens</b>	
Focal Length	2.8 mm
Iris Type	Fixed
Iris	F1.6
Field of View (H)	93.2°
Field of View (V)	51.5°
Field of View (D)	108.0°
Lens Type	Fixed
<b>DORI</b>	
DORI Distance (Lens)	2.8 mm
DORI Distance (Detect)	63.0 m (206.7 ft.)
DORI Distance (Observe)	25.2 m (82.7 ft.)
DORI Distance (Recognize)	12.6 m (41.3 ft.)
DORI Distance (Identify)	6.3 m (20.7 ft.)
<b>Illuminator</b>	
Supplemental Light	Dual light
Illumination Distance (IR)	30 m (98.4 ft.)
Illumination Distance (Warm Light)	30 m (98.4 ft.)
Wavelength	850 nm
<b>Video</b>	
Video Compression	Ultra 265, H.265, H.264
H.264 Code Profile	Baseline profile, Main profile, High profile
Frame Rate	Main Stream: 4 MP (2560 × 1440), max. 25 fps; 3 MP (2304 × 1296), max. 30 fps; 1080P (1920 × 1080), max. 30 fps; Sub Stream: D1 (720 × 576), max. 30 fps; 640 × 360, max. 30 fps; 2CIF (704 × 288), max. 30 fps; CIF (352 × 288), max. 30 fps;
Video Bit Rate	128 Kbps to 6144 Kbps
U-code	Support
OSD	Up to 4 OSDs
Privacy Mask	Up to 4 areas





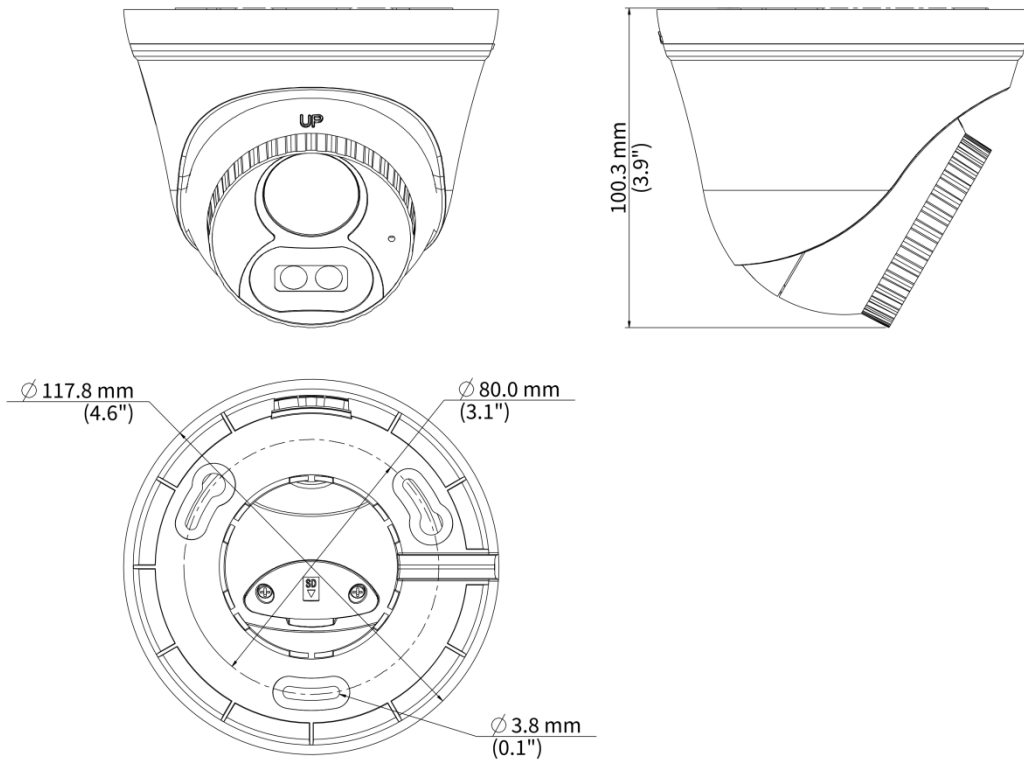

ROI	Support
Video Stream	Dual streams
<b>Image</b>	
White Balance	Auto, Outdoor, Fine tune, Sodium lamp, Locked, Auto2, Area white balance
Digital Noise Reduction	2D/3D DNR
Smart IR	Support
Flip	Normal, Flip vertical, Flip horizontal, 180°, 90° Clockwise, 90° Anti-clockwise
Dewarping	N/A
HLC	Support
BLC	Support
Defog	Digital defog
Image Stabilization	N/A
<b>Events</b>	
Basic Detection	Ultra motion detection, Motion detection, Audio detection, Tampering alarm
General Function	Watermark, IP address filtering, Access policy, ARP protection, RTSP authentication, User authentication, HTTP authentication
<b>Audio</b>	
Audio Compression	G.711U, G.711A
Audio Bitrate	64 Kbps
Two-way Audio	N/A
Suppression	Support
Sampling Rate	8 kHz
<b>Storage</b>	
Edge Storage	MicroSD, up to 512 GB
Network Storage	ANR, NAS (NFS)
<b>Network</b>	
Protocols	IPv4, IGMP, ICMP, ARP, TCP, UDP, DHCP, RTP, RTSP, RTCP, RTMP, DNS, DDNS, NTP, UPnP, HTTP, HTTPS, QoS, SSL/TLS, SNMP
Compatible Integration	API, SDK
User/Host	Up to 32 users. 3 user levels: administrator, common user and operator
Security	Password Protection, Strong Password, HTTPS Encryption, Export Operation Logs, Basic and Digest Authentication for RTSP, Digest Authentication for HTTP, TLS 1.2, WSSE and Digest Authentication for ONVIF
Client	EZStation, APP
Web Browser	Plug-in required live view: IE 10+, Chrome 45+, Firefox 52+, Edge 79+, Plug-in free live view: Chrome 57+, Firefox 58+, Edge 16+
<b>Interface</b>	
Audio I/O	N/A
Alarm I/O	N/A
Serial Port	N/A
Built-in Mic	Support
Built-in Speaker	N/A
WIFI	N/A

Network	1 × RJ45 10 M/100 M Base-TX Ethernet
Video Output	N/A
<b>Certification</b>	
EMC	CE-EMC (EN 55032, EN 61000-3-3, EN IEC 61000-3-2, EN 50130-4) FCC (FCC 47 CFR part15 B)
Safety	CE LVD (EN 62368 1) UL/CUL (UL 62368 1, CAN/CSA C22.2 No. 62368 1)
Environment	CE-RoHS (2011/65/EU;(EU)2015/863); WEEE (2012/19/EU);
Protection	IP67 (IEC 60529)
<b>General</b>	
Power	DC 12 V±25%, PoE (IEEE 802.3af)
Power Consumption	Max. 4.2 W
Power Interface	Ø5.5 mm coaxial power plug
Dimensions	Ø117.8 mm × 100.3 mm (Ø4.6" × 3.9") (Ø × H)
Weight	0.26 kg (0.57 lb.)
Material	Graphene + Plastic
Storage Environment	-30 °C to 60 °C (-22 °F to 140 °F), Humidity: ≤ 95% RH (non-condensing)
Working Environment	-30 °C to 60 °C (-22 °F to 140 °F), Humidity: ≤ 95% RH (non-condensing)
Surge Protection	4 KV
Reset Button	Support
Web Client Language	4 Languages: English, Russian, Spanish, Vietnamese

## Dimensions



## Accessories

<p><b>TR-JB03-I-IN</b> Junction Box for Turret Camera(Support wiring from behind)</p>	<p><b>TR-A01-IN</b> NPT 3/4" Waterproof Cable Gland</p>	<p><b>TR-SE24-IN</b> Dome Pendant Mounting Pole 200mm</p>
		
<p><b>TR-SE24-A-IN</b> Dome Pendant Mounting Pole 500mm</p>	<p><b>TR-CM24-IN</b> Dome Pendant Mounting Bracket(Indoor)</p>	<p><b>TR-WM07P-B</b> Dome Wall Mounting Plastic Bracket</p>
		

<p><b>TR-JB07/WM03-G-IN-V2</b> Wall Mounting Assembling Bracket For 32 Fix-dome&amp;Mini Fix-dome&amp;Plastic Turret Camera</p>	<p><b>TR-WM03-D-IN-V2</b> Wall Mounting Bracket for 32 Fix-dome&amp;Mini Fix-dome&amp;Plastic Turret Camera</p>	<p><b>TR-UC08-C-V2</b> Bullet&amp;Dome Corner Mounting Bracket</p>
		
<p><b>TR-UP06-C-IN-V2</b> Pole Mounting Bracket for Bullet Junction Box Only</p>		
		

# Unlimited New View

## Zhejiang Uniview Technologies Co., Ltd.



<http://www.uniview.com>



[overseasbusiness@uniview.com](mailto:overseasbusiness@uniview.com); [globalsupport@uniview.com](mailto:globalsupport@uniview.com)



No. 369, Xietong Road, Xixing Sub-district, Binjiang District, Hangzhou City, 310051, Zhejiang Province, China



©2023-2025 Zhejiang Uniview Technologies Co., Ltd. All rights reserved.

\*Product specifications and availability are subject to change without notice.

Despite our best efforts, technical or typographical errors may exist in this document. Uniview cannot be held responsible for any such errors and reserves the right to change the contents of this document without prior notice.