

# 5MP HD Wide Angle Intelligent IR Fixed Bullet Network Camera

IPC2105SB-ADF16KM-I0



## Features

- High quality image with 5MP, 1/2.7"CMOS sensor
- 5MP (2880\*1620)@30/25fps; 4MP (2560\*1440)@30/25fps; 3MP(2304\*1296) @30/25fps; 2MP (1920\*1080) @30/25fps
- Wide Angle technology realize the horizontal viewing angle of 180°
- The dewarp level can be configured in the range of 1-9
- Ultra 265,H.264,H.265, MJPEG
- Smart intrusion prevention, include cross line, intrusion, enter area, leave area detection
- Based on target classification, smart intrusion prevention significantly reduce false alarm caused by leaves, birds and lights etc., accurately focus on human and, motor vehicle and non-motor vehicle
- 120dB true WDR technology enables clear image in strong light scene
- Built-in Mic
- Smart IR, up to 20m (66ft) IR distance
- Supports 512 GB Micro SD card
- DC12V or PoE(IEEE 802.3af) power supply
- IP67 protection

- 3-Axis

## Specifications

Model	IPC2105SB-ADF16KM-I0
<b>Camera</b>	
Max Resolution	5 MP
Sensor	1/2.7" CMOS
Min. Illumination	Colour: 0.01 lux (F2.0, AGC ON) 0 lux with IR on
Day/Night	IR-cut filter with auto switch (ICR)
Shutter	Auto/Manual, 1 ~ 1/100000s
Adjustment Angle	Pan: 0° ~ 360°, Tilt: 0° ~ 90°, Rotate: 0° ~ 360°
S/N	>52 dB
WDR	120 dB
<b>Lens</b>	
Focal Length	1.68 mm
Iris Type	Fixed
Iris	F2.0
Field of View (H)	180°
Field of View (V)	100°
Field of View (D)	180°
<b>DORI</b>	
DORI Distance (Lens)	1.68mm
DORI Distance (Detect)	37.8(124.0ft)
DORI Distance (Observe)	15.1(49.6ft)
DORI Distance (Recognize)	7.6(24.8ft)
DORI Distance (Identify)	3.8(12.4ft)
<b>Illuminator</b>	
Supplemental Light	IR
Illumination Distance (IR)	20 m (65.6 ft)
IR On/Off Control	Auto/Manual

Wavelength	850 nm
<b>Video</b>	
Video Compression	Ultra 265, H.265, H.264, MJPEG
H.264 Code Profile	Baseline profile, Main profile, High profile
Frame Rate	Main Stream: 5MP (2880*1620), Max 30fps; 4MP (2560*1440), Max 30fps; 3MP (2304*1296), Max 30fps; 1080P (1920*1080), Max 30fps; 1280*720 Max 30fps Sub Stream: 1080P (1920*1080), Max 30fps; 720P (1280*720), Max 30fps; D1 (720*576), Max 30fps; 640*360, Max 30fps; 2CIF(704*288), Max 30fps; CIF(352*288), Max 30fps; Third Stream: D1 (720*576), Max 30fps; 640*360, Max 30fps; 2CIF(704*288), Max 30fps; CIF(352*288), Max 30fps;
Video Bit Rate	128 Kbps to 16 Mbps
U-code	Support
OSD	Up to 8 OSDs
Privacy Mask	Up to 4 areas
ROI	Support
Video Stream	Triple Streams
<b>Image</b>	
White Balance	Auto, Outdoor, Fine Tune, Sodium Lamp, Locked, Auto2
Smart IR	Support
Digital Noise Reduction	2D/3D DNR
Flip	Normal, Flip Vertical, Flip Horizontal, 180°
Dewarping	Support
HLC	Support
BLC	Support
Defog	Digital Defog
Image Stabilization	N/A
Low Illumination Characteristics	Low-light
<b>Intelligent</b>	

Smart Intrusion Prevention	Cross line detection, intrusion detection, enter area detection, leave area detection (support false alarm filtering and the classification of human, non-motor vehicle and vehicle)
<b>Events</b>	
Basic Detection	Motion Detection, Ultra Motion Detection, Tampering Alarm, Audio Detection
General Function	Watermark, IP Address Filtering, Access Policy, ARP Protection, RTSP Authentication, User Authentication, HTTP Authentication
<b>Audio</b>	
Audio Compression	G.711U, G.711A
Audio Bitrate	64 Kbps
Two-way Audio	N/A
Suppression	Support
Sampling Rate	8 kHz
<b>Storage</b>	
Edge Storage	Micro SD, up to 512 GB
Network Storage	ANR, NAS (NFS)
<b>Network</b>	
Protocols	IPv4, IPv6, IGMP, ARP, TCP, UDP, DHCP, PPPoE, RTP, RTSP, RTCP, RTMP, DNS, DDNS, NTP, FTP, HTTP, HTTPS, SMTP, 802.1x, SNMP, QoS
Compatible Integration	ONVIF (Profile S, Profile G, Profile T, Profile M), API, SDK
User/Host	Up to 32 users. 3 user levels: administrator, common user and operator
Security	Password Protection, Strong Password, HTTPS Encryption, Export Operation Logs, Basic and Digest Authentication for RTSP, Digest Authentication for HTTP, TLS 1.2, WSSE and Digest Authentication for ONVIF
Client	UNV-Link, UNV-Link Pro, EZStation

Web Browser	Plug-in required live view: IE 10+, Chrome 45+, Firefox 52+, Edge 79+, Plug-in free live view: Chrome 57+, Firefox 58+, Edge 16+
<b>Interface</b>	
Audio I/O	N/A
Alarm I/O	N/A
Serial Port	N/A
Built-in Mic	Support
Built-in Speaker	N/A
WIFI	N/A
Network	1 × RJ45 10 M/100 M Base-TX Ethernet
Video Output	N/A
<b>Certification</b>	
EMC	CE-EMC (EN 55032, EN 61000-3-3, EN IEC 61000-3-2, EN 55035) FCC (FCC 47 CFR part15 B)
Safety	CE LVD (EN 62368-1) CB (IEC 62368-1) UL/CUL (UL 62368-1, CAN/CSA C22.2 No. 62368-1)
Environment	CE-RoHS (2011/65/EU;(EU)2015/863); WEEE (2012/19/EU);
Protection	IP67 (IEC 60529)
<b>General</b>	
Power	DC 12V±25%, PoE (IEEE 802.3af)
Power Consumption	Max 5.5W
Power Interface	Ø5.5 mm coaxial power plug
Dimensions	198× 71 × 71mm (7.8" × 2.8" × 2.8") (L x W x H)
Weight	0.42kg (0.93lb)
Material	Metal
Working Environment	-30 °C to 60 °C (-22 °F to 140 °F), Humidity: ≤ 95% RH (non-condensing)
Storage Environment	-30 °C to 60 °C (-22 °F to 140 °F), Humidity: ≤ 95% RH (non-condensing)

Surge Protection	4 KV
Reset Button	Support
Web Client Language	20 Languages: Traditional Chinese, English, Simplified Chinese, Polish, German, Russian, French, Korean, Dutch, Czech, Portuguese (Europe), Portuguese (Brazil), Japanese, Thai, Turkish, Spanish (Latin America), Spanish (Europe), Hungarian, Italian, Vietnamese

## Dimensions

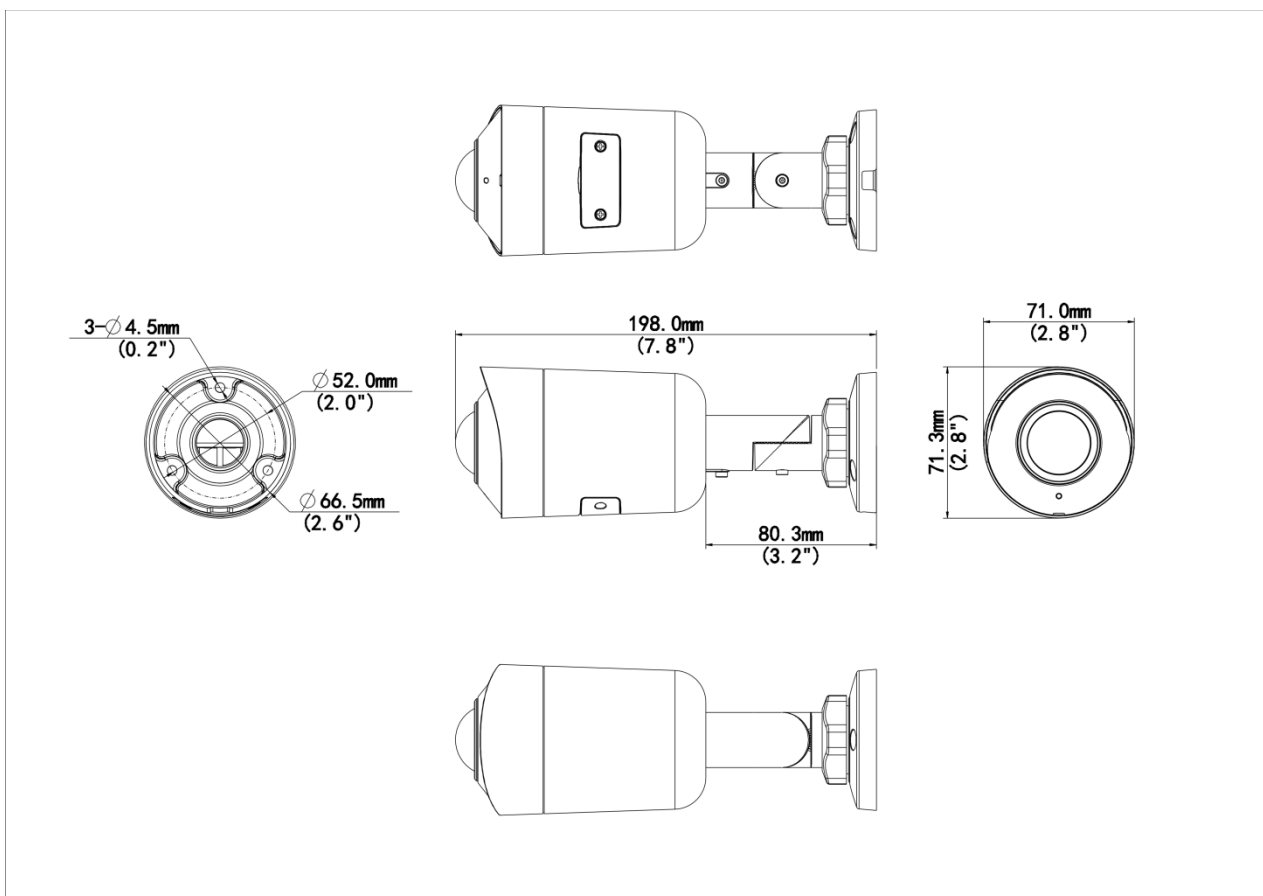

## Accessories

TR-JB05-B-IN

Small Bullet Junction Box(Elegant White)



TR-UP06-C-IN

Pole Mounting Bracket for Bullet Junction Box Only



TR-A01-IN

NPT 3/4" Waterproof Cable Gland



TR-UC08-C

Bullet&Dome Corner Mounting Bracket

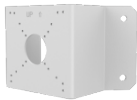

**Zhejiang Uniview Technologies Co., Ltd.**

No. 369, Xietong Road, Xixing Sub-district, Binjiang District, Hangzhou City, 310051, Zhejiang Province, China (Zhejiang) Pilot Free Trade Zone, China

Email: [overseasbusiness@uniview.com](mailto:overseasbusiness@uniview.com); [globalsupport@uniview.com](mailto:globalsupport@uniview.com)

<http://www.uniview.com>

©2023-2024 Zhejiang Uniview Technologies Co., Ltd. All rights reserved.

\*Product specifications and availability are subject to change without notice.

\*Despite our best efforts, technical or typographical errors may exist in this document. Uniview cannot be held responsible for any such errors and reserves the right to change the contents of this document without prior notice.