

TR-UV06-A-IN Housing Bracket

TR-UV06-A-IN

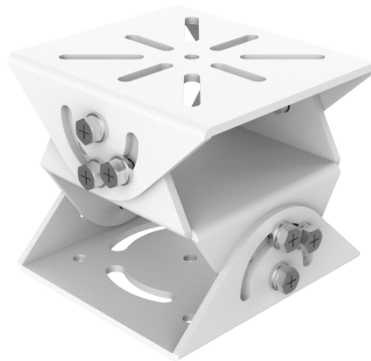

Specifications

Model	TR-UV06-A-IN
Bracket	
Application	Outdoor, pole or rail installation for housing
Bracket Dimensions	115mmx103mmx100mm (4.5"x4.1"x3.9")
Bracket Weight	0.8kg(1.76lb)
Bearable Load	20kg(44.1lb)
Bracket Material	Aluminum alloy
Adjustable Range	Horizontal: 360°; Vertical: 90°

Dimensions

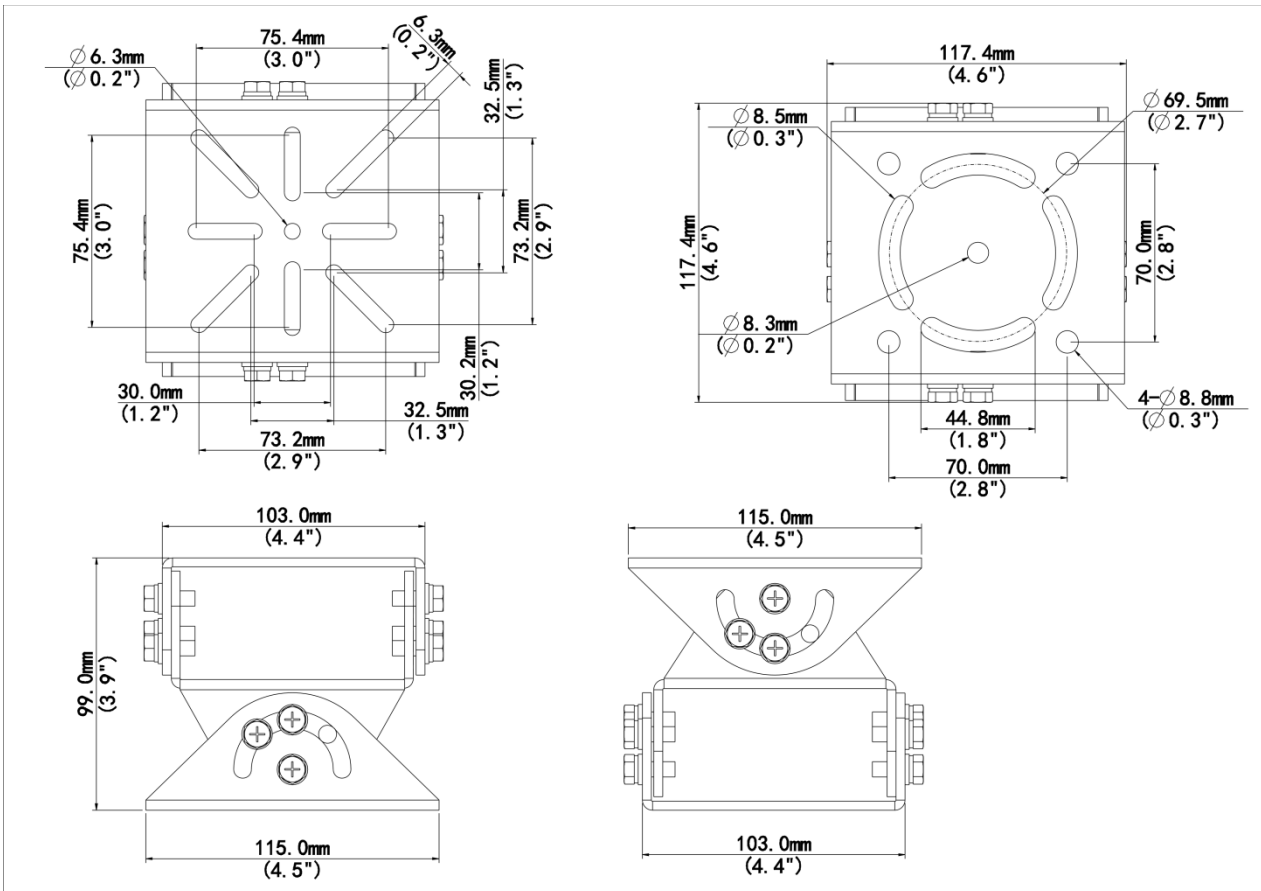

Zhejiang Uniview Technologies Co., Ltd.

No. 369, Xietong Road, Xixing Sub-district, Binjiang District, Hangzhou City, 310051, Zhejiang Province, China (Zhejiang) Pilot Free Trade Zone, China

Email: overseasbusiness@uniview.com; globalsupport@uniview.com

<http://www.uniview.com>

©2023-2024 Zhejiang Uniview Technologies Co., Ltd. All rights reserved.

*Product specifications and availability are subject to change without notice.

*Despite our best efforts, technical or typographical errors may exist in this document. Uniview cannot be held responsible for any such errors and reserves the right to change the contents of this document without prior notice.