

# 4MP Dual-light WDR Mini Dome Network Camera IPC314LE-ADF28K-DL



## Features

- High quality image with 4MP, 1/3.0" CMOS sensor
- 4 MP (2688 × 1520)@25/20 fps; 4 MP (2560 × 1440)@25/20 fps; 3 MP (2304 × 1296)@30/25 fps; 1080P (1920 × 1080)@30/25 fps
- Ultra 265, H.265, H.264, MJPEG
- Smart intrusion prevention, including cross line, intrusion detection
- Support ultra motion detection (human/ vehicle detection)
- ColorHunter technology ensures 24-hour full-color images
- 120 dB true WDR technology enables clear image in strong light scene
- Supports 9:16 corridor mode
- Built in mic
- Smart IR, up to 30 m (98.4 ft) IR distance
- Warm light, up to 30 m (98.4 ft) warm light distance
- MicroSD, up to 512 GB
- IP67 protection

## Specifications

Model	IPC314LE-ADF28K-DL
<b>Camera</b>	
Max Resolution	4 MP
Sensor	1/3.0" CMOS
Min. Illumination	Color: 0.005 Lux (F1.6, AGC ON), 0 Lux with IR
Day/Night	IR-cut filter with auto switch (ICR)
Shutter	Auto/Manual, 1 to 1/100000 s
Adjustment Angle	Pan: -48° to 48°, Tilt: 0° to 80°, Rotate: 0° to 360°
S/N	> 52 dB
WDR	120 dB
<b>Lens</b>	
Focal Length	2.8 mm
Iris Type	Fixed
Iris	F1.6
Field of View (H)	100.5°
Field of View (V)	58.4°
Field of View (D)	123.1°
Lens Type	Fixed
<b>DORI</b>	
DORI Distance (Lens)	2.8 mm
DORI Distance (Detect)	63.0 m (206.7 ft.)
DORI Distance (Observe)	25.2 m (82.7 ft.)
DORI Distance (Recognize)	12.6 m (41.3 ft.)
DORI Distance (Identify)	6.3 m (20.7 ft.)
<b>Illuminator</b>	
Supplemental Light	Dual light
Illumination Distance (IR)	30 m (98.4 ft.)
IR On/Off Control	Auto/Manual
Wavelength	850 nm
<b>Video</b>	
Video Compression	Ultra 265, H.265, H.264, MJPEG
H.264 Code Profile	Baseline profile, High profile
Frame Rate	Main Stream: 4MP (2688 × 1520), max.25 fps; 4MP (2560 × 1440), max.25 fps; 3MP (2304 × 1296), max.30 fps; 1080P (1920 × 1080), max. 30 fps; 720P (1280 × 720), max. 30 fps; Sub Stream: 720P (1280 × 720), max. 30 fps; D1 (720 × 576), max. 30 fps; 640 × 360, max. 30 fps; 2CIF (704 × 288), max. 30 fps; CIF (352 × 288), max. 30 fps;
Video Bit Rate	128 Kbps to 6144 Kbps
U-code	Support
OSD	Up to 4 OSDs
Privacy Mask	Up to 4 areas
ROI	Support



Video Stream	Dual streams
<b>Image</b>	
Smart IR	Support
White Balance	Auto, Outdoor, Fine tune, Locked, Sodium lamp, Auto2, Area white balance
Digital Noise Reduction	2D/3D DNR
Flip	Normal, Flip vertical, Flip horizontal, 180°, 90° Clockwise, 90° Anti-clockwise
Dewarping	N/A
HLC	Support
BLC	Support
Defog	Digital defog
<b>Intelligent</b>	
People Counting	N/A
Statistical Analysis	N/A
<b>Events</b>	
Basic Detection	Motion detection, Audio detection, Tampering alarm, Ultra motion detection (human/ vehicle detection) , Cross line (based on human body detection), Intrusion (based on human body detection)
General Function	Watermark, IP address filtering, Access policy, ARP protection, RTSP authentication, HTTP authentication, User authentication
<b>Audio</b>	
Audio Compression	G.711U, G.711A
Audio Bitrate	64 Kbps
Two-way Audio	N/A
Suppression	Support
Sampling Rate	8 kHz
<b>Storage</b>	
Edge Storage	MicroSD, up to 512 GB
Network Storage	NAS (NFS)
<b>Network</b>	
Protocols	IPv4, IPv6, IGMP, ICMP, ARP, TCP, UDP, DHCP, RTP, RTSP, RTCP, RTMP, DNS, DDNS, NTP, FTP, UPnP, HTTP, HTTPS, SMTP, SSL/TLS, SNMP, QoS, SSH
Compatible Integration	SDK, API, ONVIF (Profile S, Profile G, Profile T)
User/Host	Up to 32 users. 2 user levels: administrator and common user
Security	DTLS 1.2, TLS 1.2, Strong Password, HTTPS, Password protection, HTTPS encryption, Basic and Digest Authentication for RTSP, WSSE and Digest Authentication for ONVIF, Digest Authentication for HTTP, RTP/RTSP over HTTPS, Audit logs, Configuration Encrypted Storage, Configuration Encrypted Export, Digital Watermarking, Gateway ARP Binding, Digest SHA256 Authentication for HTTP, Digest SHA256 Authentication for RTSP, IP Filtering
Client	EZStation, APP
Web Browser	Plug-in free live view: Chrome 57+, Firefox 58+, Edge 16+
<b>Interface</b>	
Audio I/O	N/A



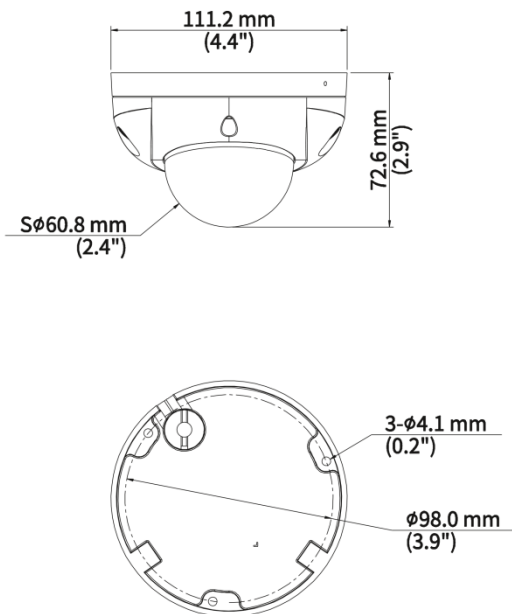

Alarm I/O	N/A
Serial Port	N/A
Built-in Mic	Support
Built-in Speaker	N/A
WIFI	N/A
Network	1 × RJ45 10 M/100 M Base-TX Ethernet
Video Output	N/A
<b>Certification</b>	
EMC	CE-EMC (EN 55032, EN 61000-3-3, EN IEC 61000-3-2, EN 50130-4) FCC (FCC 47 CFR part15 B)
Safety	CE LVD (EN 62368-1) UL/CUL (UL 62368-1, CAN/CSA C22.2 No. 62368-1)
Environment	CE-RoHS (2011/65/EU;(EU)2015/863); WEEE (2012/19/EU);
Protection	IP67 (IEC 60529) IK10 (IEC 62262)
<b>General</b>	
Power	DC 12 V±25%, PoE (IEEE 802.3af)
Power Consumption	Max 5.6 W
Power Interface	Ø5.5 mm coaxial power plug
Dimensions	Ø111.2 mm × 72.6 mm (Ø4.4" × 2.9") (Ø × H)
Weight	0.36kg (0.79lb)
Material	Metal + Plastic
Working Environment	-30 °C to 60 °C (-22 °F to 140 °F), Humidity: ≤ 95% RH (non-condensing)
Storage Environment	-40 °C to 70 °C (-40 °F to 158 °F), Humidity: ≤ 95% RH (non-condensing)
Surge Protection	4 KV
Reset Button	Support
Web Client Language	4 Languages: English, Russian, Spanish, Vietnamese

# Dimensions



# Accessories

<p><b>TR-JB03-G-IN</b></p> <p>Junction Box for Mini Fix-dome(Support wiring from behind)</p>	<p><b>TR-WM03-D-IN-V2</b></p> <p>Wall Mounting Bracket for 32 Fix-dome&amp;Mini Fix-dome&amp;Plastic Turret Camera</p>	<p><b>TR-UM06-E-IN</b></p> <p>Slant Mounting Bracket for Fixed Dome</p>
		
<p><b>TR-A01-IN</b></p> <p>NPT 3/4" Waterproof Cable Gland</p>	<p><b>TR-UP06-C-IN-V2</b></p> <p>Pole Mounting Bracket for Bullet Junction Box Only</p>	<p><b>TR-UC08-C-V2</b></p> <p>Bullet&amp;Dome Corner Mounting Bracket</p>
		

<p><b>TR-SE24-IN</b></p>	<p><b>TR-SE24-A-IN</b></p>	<p><b>TR-CM24-IN</b></p>
<p>Dome Pendant Mounting Pole 200mm</p>	<p>Dome Pendant Mounting Pole 500mm</p>	<p>Dome Pendant Mounting Bracket(Indoor)</p>
		
<p><b>TR-JB07/WM03-G-IN-V2</b></p>		
<p>Wall Mounting Assembling Bracket For 32 Fix-dome&amp;Mini Fix-dome&amp;Plastic Turret Camera</p>		
		

# Unlimited New View

## Zhejiang Uniview Technologies Co., Ltd.



<http://www.uniview.com>



[overseasbusiness@uniview.com](mailto:overseasbusiness@uniview.com); [globalsupport@uniview.com](mailto:globalsupport@uniview.com)



No. 369, Xietong Road, Xixing Sub-district, Binjiang District, Hangzhou City, 310051, Zhejiang Province, China



©2023-2025 Zhejiang Uniview Technologies Co., Ltd. All rights reserved.

\*Product specifications and availability are subject to change without notice.

Despite our best efforts, technical or typographical errors may exist in this document. Uniview cannot be held responsible for any such errors and reserves the right to change the contents of this document without prior notice.