

4MP IR Fixed Bullet Network Camera

IPC-B234-AF40-ECO

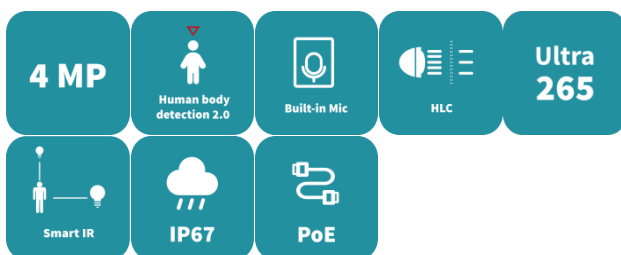

Features

- High quality image with 4 MP, 1/3.0" CMOS sensor
- 4 MP (2560 × 1440)@25/20 fps; 3 MP (2304 × 1296)@30/25 fps; 1080P (1920 × 1080)@30/25 fps
- Supports accurate human body detection 2.0
- Ultra 265, H.265, H.264
- 2D/3D DNR (digital noise reduction)
- ROI (region of interest) ensures image quality in areas of interest with low bandwidth
- Smart IR, up to 30 m (98.4 ft.) IR distance
- 3-axis
- Built-in mic
- Wide temperature range: -30 °C to 60 °C (-22 °F to 140 °F)
- Supports PoE power supply
- IP67

Specifications

Model	IPC-B234-AF40-ECO
Camera	
Max Resolution	4 MP
Sensor	1/3.0" CMOS
Min. Illumination	Color: 0.01 Lux (F2.0, AGC ON), 0 Lux with IR on
Day/Night	IR-cut filter with auto switch (ICR)
Shutter	Auto/Manual, 1 to 1/100000 s
Adjustment Angle	Pan: 0° to 360°, Tilt: 0° to 90°, Rotate: 0° to 360°
S/N	> 52 dB
WDR	DWDR
Lens	
Focal Length	4.0 mm
Iris	F2.0
Field of View (H)	74.6°
Field of View (V)	40.5°
Field of View (D)	89.1°
Lens Type	Fixed
Iris Type	Fixed
DORI	
DORI Distance (Lens)	4 mm
DORI Distance (Detect)	90.0 m (295.3 ft)
DORI Distance (Observe)	36.0 m (118.1 ft.)
DORI Distance (Recognize)	18.0 m (59.1 ft.)
DORI Distance (Identify)	9.0 m (29.5 ft.)
Illuminator	
Supplemental Light	IR
Illumination Distance (IR)	30 m (98.4 ft.)
Wavelength	850 nm
Video	
Video Compression	Ultra 265, H.265, H.264
H.264 Code Profile	Baseline profile, Main profile, High profile
Frame Rate	Main Stream: 4 MP (2560 × 1440), max. 25 fps; 3 MP (2304 × 1296), max. 30 fps; 1080P (1920 × 1080), max. 30 fps Sub Stream: 640 × 360, max. 30 fps; 2CIF (704 × 288), max. 30 fps; CIF (352 × 288), max. 30 fps
Video Bit Rate	128 Kbps to 6144 Kbps
OSD	Up to 4 OSDs
U-code	Support
Privacy Mask	Up to 4 areas
ROI	Support
Video Stream	Dual streams



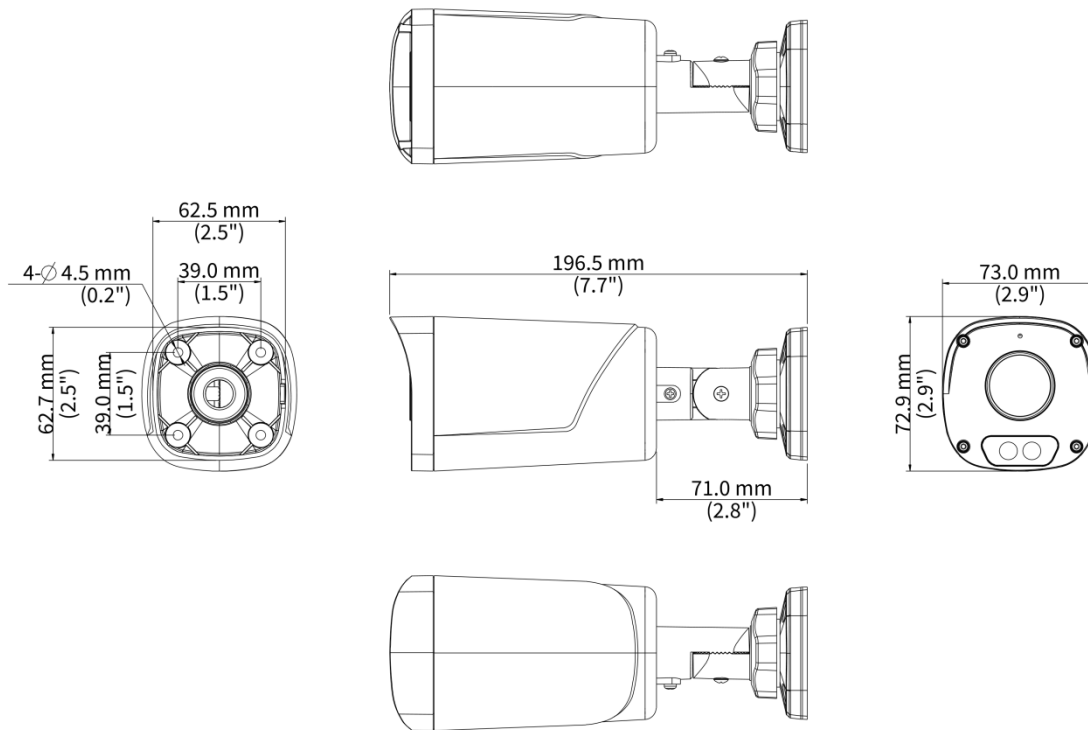

Image	
Smart Illumination	Support
White Balance	Auto, Outdoor, Fine tune, Sodium lamp, Locked, Auto2, Area white balance
Digital Noise Reduction	2D/3D DNR
Smart IR	Support
Flip	Normal, Flip vertical, Flip horizontal, 180°
Dewarping	N/A
HLC	Support
BLC	Support
Image Stabilization	N/A
Defog	Digital defog
Audio	
Audio Compression	G.711U, G.711A
Audio Bitrate	64 Kbps
Two-way Audio	N/A
Suppression	Support
Sampling Rate	8 kHz
Events	
Basic Detection	Motion detection, Audio detection, Human body detection 2.0
General Function	Watermark, IP address filtering, Access policy, ARP protection, RTSP authentication, User authentication, HTTP authentication
Storage	
Edge Storage	N/A
Network	
Protocols	IPv4, IGMP, ICMP, ARP, TCP, UDP, DHCP, RTP, RTSP, RTCP, RTMP, DNS, DDNS, NTP, UPnP, HTTP, HTTPS, SNMP, QoS, SSL/TLS
Compatible Integration	ONVIF (Profile S, Profile T) , API, SDK
Client	APP, Uniarch client
Web Browser	Plug-in required live view: IE 10+, Chrome 45+, Firefox 52+, Edge 79+, Plug-in free live view: Chrome 57+, Firefox 58+, Edge 16+
Security	Password Protection, Strong Password, Export Operation Logs, Basic and Digest Authentication for RTSP, Digest Authentication for HTTP, WSSE and Digest Authentication for ONVIF
User/Host	Up to 32 users. 3 user levels: administrator, common user and operator
Interface	
Audio I/O	N/A
Alarm I/O	N/A
Serial Port	N/A
Built-in Mic	Support
Built-in Speaker	N/A
WIFI	N/A
Network	1 × RJ45 10 M/100 M Base-TX Ethernet
Video Output	N/A
Certification	

Protection	IP67 (IEC 60529)
EMC	CE-EMC (EN 55032, EN 61000-3-3, EN IEC 61000-3-2, EN 50130-4) FCC (FCC 47 CFR part15 B)
Safety	CE LVD (EN 62368-1)
Environment	CE-RoHS (2011/65/EU;(EU)2015/863) WEEE (2012/19/EU) Packaging and Packaging Waste (94/62/EC)
General	
Power	PoE (IEEE 802.3af)
Power Consumption	Max. 3.1 W
Power Interface	N/A
Dimensions	196.5 mm × 73.0 mm × 72.9 mm (7.7" × 2.9" × 2.9") (L × W × H)
Weight	0.22 kg (0.49 lb.)
Material	Graphene + Plastic
Working Environment	-30 °C to 60 °C (-22 °F to 140 °F), Humidity: ≤ 95% RH (non-condensing)
Storage Environment	-30 °C to 60 °C (-22 °F to 140 °F), Humidity: ≤ 95% RH (non-condensing)
Surge Protection	4 KV
Reset Button	N/A
Web Client Language	4 Languages: English, Russian, Spanish, Vietnamese

Dimensions



Accessories

<p>TR-JB05-A-IN Small Bullet Junction Box(Support wiring from behind,Square)</p>	<p>TR-UP06-B-IN Bullet Pole Mounting Bracket</p>	<p>TR-A01-IN NPT 3/4" Waterproof Cable Gland</p>
		
<p>TR-UP06-C-IN-V2 Pole Mounting Bracket for Bullet Junction Box Only</p>	<p>TR-UC08-C-V2 Bullet&Dome Corner Mounting Bracket</p>	
		

Zhejiang Uniview Technologies Co., Ltd.



<http://www.uniview.com>



overseasbusiness@uniview.com; globalsupport@uniview.com



No. 369, Xietong Road, Xixing Sub-district, Binjiang District, Hangzhou City, 310051, Zhejiang Province, China



©2023-2025 Zhejiang Uniview Technologies Co., Ltd. All rights reserved.

*Product specifications and availability are subject to change without notice.

*Despite our best efforts, technical or typographical errors may exist in this document.

Uniview cannot be held responsible for any such errors and reserves the right to change the contents of this document without prior notice.