

8MP 42X LightHunter Laser Wiper Network PTZ Camera IPC6828EL-X42-W-VH1



Features

- 3840 × 2160@30 fps in the main stream
- 42X optical zoom
- Smart intrusion prevention, supports false alarm filtering, including cross line, intrusion, enter area, leave area detection
- automatic selection of best snapshots, supports face detection masked area
- supports front-end , supports blocklist and allowlist comparison
- People counting, supports people flow counting and crowd density monitoring
- Multi-target detection, supports human body, motor vehicle and non-motor vehicle image capture and attribute collection, realizes data visualization management, allows users to get target information for further data analysis
- Supports optical defog, self-adaptive defog
- LightHunter technology ensures ultra-high image quality in low illumination environment
- IR illumination: 500 m (1640 ft) distance, proportional to optical zoom of camera module
- Gyroscope stabilization for stable picture
- Supports wiper
- Power supply: AC 24 V±25%, DC 24 V±25%, PoE
- Alarm I/O: 7/2, audio I/O: 1/1
- IP67 ingress protection

Specifications

Model	IPC6828EL-X42-W-VH1
Camera	
Sensor	1/1.8" CMOS
Min. Illumination	Color: 0.0005 Lux (F1.2, AGC ON), 0 Lux with IR
Day/Night	IR-cut filter with auto switch (ICR)
Shutter	Auto/Manual, 1 to 1/100000 s
WDR	120 dB
S/N	>56 dB
Lens	
Focal Length	6.0~252mm
Digital Zoom	16X
Optical Zoom	42X
Iris	F1.2 to F4.6
Field of View (H)	57.96° to 2.15°
Field of View (V)	34.61° to 1.21°
Field of View (D)	71.30° to 2.54°
DORI	
DORI Distance (Detect)	155.5 m to 4829.4 m (510.1 ft. to 15844.5 ft.)
DORI Distance (Observe)	62.2 m to 1931.8 m (204.0 ft. to 6337.8 ft.)
DORI Distance (Recognize)	31.1 m to 965.9 m (102.0 ft. to 3168.9 ft.)
DORI Distance (Identify)	15.5 m to 482.9 m (51.0 ft. to 1584.4 ft.)
Video	
Privacy Mask	24 areas, up to 8 areas per scene
Video Compression	Ultra 265, H.265, H.264, MJPEG
Frame Rate	Main Stream: 8 MP (3840 × 2160), max. 30 fps Sub Stream: 1080P (1920 × 1080), max. 30 fps Third Stream: D1 (720 × 576), max. 30 fps
Video Bit Rate	128 Kbps to 16 Mbps
U-code	Support
ROI	Support
Video Stream	Triple streams
OSD	Up to 10 OSDs
Intelligent	
Auto Tracking	Support, target filtering: human, non-motor vehicle and vehicle
Multi-target Detection	Support
Smart Intrusion Prevention	Cross line detection, intrusion detection, enter area detection, leave area detection (support false alarm filtering and the classification of human, non-motor vehicle and vehicle)
People Counting	Support people flow counting and crowd density detection
Image	
White Balance	Auto, Outdoor, Fine tune, Sodium lamp, Locked, Auto2
Digital Noise Reduction	2D/3D DNR





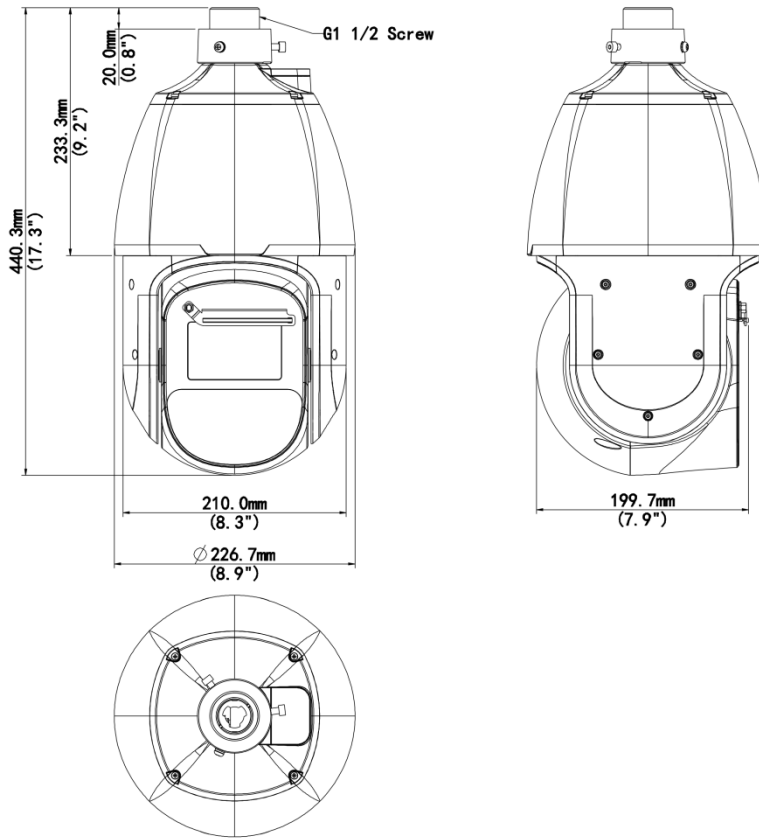

Flip	Normal, Flip vertical, Flip horizontal, 180°
HLC	Support
BLC	Support
Defog	Digital defog, Optical defog
EIS	Support
Image Stabilization	EIS (Gyroscope)
Events	
Basic Detection	Motion detection, Ultra motion detection, Tampering alarm, Audio detection, Object removed, Object Left Behind
General Function	Watermark, IP address filtering, Access policy, ARP protection, RTSP authentication, User authentication, Alarm input, Alarm output
Audio	
Audio Compression	G.711U, G.711A
Audio Bitrate	128 Kbps
Two-way Audio	Support
Suppression	Support
Sampling Rate	16 kHz
Storage	
Edge Storage	MicroSD, up to 512 GB
Network Storage	ANR, NAS (NFS)
Illuminator	
IR On/Off Control	Auto/Manual
Wavelength	850 nm
Illumination Distance (IR)	500m
Network	
Protocols	SSH, IGMP, RTP, RTCP, SMTP, IPv4, IPv6, ICMP, ARP, TCP, UDP, DHCP, PPPoE, RTSP, RTMP, DNS, DDNS, NTP, FTP, UPnP, HTTP, HTTPS, 802.1x, SNMP, QoS, SSL/TLS
Compatible Integration	ONVIF (Profile S, Profile G, Profile T, Profile M), API, SDK
User/Host	Up to 32 users. 3 user levels: administrator, common user and operator
Security	Password Protection, Strong Password, HTTPS Encryption, Export Operation Logs, Basic and Digest Authentication for RTSP, Digest Authentication for HTTP, TLS 1.2, TLS 1.3, WSSE and Digest Authentication for ONVIF
Client	EZStation, UNV-Link, UNV-Link Pro
Web Browser	Plug-in required live view: IE 10+, Chrome 45+, Firefox 52+, Edge 79+, Plug-in free live view: Chrome 57+, Firefox 58+, Edge 16+
PTZ	
Number of Presets	1024
Preset Patrol	16 patrols, up to 64 presets for each patrol
Route Patrol	16 patrols, up to 32 actions for each patrol
Recorded Patrol	16 patrols, up to 128 actions for each patrol
Patrol Stay Time	15 s to 1800 s
Preset Image Freeze	Support
Home Position	Support





Pan Range	360° (endless)
Tilt Range	-15° to 90° (auto flip)
Pan Speed	0.1°/s to 180°/s
Tilt Speed	0.1°/s to 180°/s
Interface	
Audio I/O	1 Input: impedance 1 k Ω , amplitude 2.5 V [p-p], 1 Output: impedance 600 Ω , amplitude 2.5 V [p-p]
Alarm I/O	7/2
Serial Port	1 * RS485
Network	1 \times RJ45 10 M/100 M Base-TX Ethernet
Video Output	1 BNC (for debugging)
Certification	
EMC	CE-EMC (EN 55032: 2015+ A11: 2020; EN IEC 61000-3-2: 2019; EN 61000-3-3: 2013+ A: 2019; EN 55035: 2017+ A11: 2020)
Safety	CE LVD (EN IEC 62368-1: 2020+ A11: 2020)
Environment	CE-ROHS (2011/65/EU;(EU)2015/863)
Protection	IP67 (IEC 60529:1989+AMD1:1999+AMD2:2013)
General	
Power	AC 24 V \pm 25%, DC 24 V \pm 25%, PoE (IEEE 802.3bt)
Power Consumption	Max. 67 W
Power Interface	Wires with cold-pressed terminal
Dimensions	\varnothing 226.7 mm \times 440.3 mm (\varnothing 8.93" \times 17.33") ($\varnothing \times$ H)
Weight	6.9 kg (15.21 lb.)
Working Environment	-40 °C to 70 °C (-40 °F to 158 °F), Humidity: \leq 95% RH (non-condensing)
Storage Environment	-40 °C to 70 °C (-40 °F to 158 °F), Humidity: \leq 95% RH (non-condensing)
Surge Protection	6 KV
Reset Button	Support
Heater	Support
Configurable	
P/N	Support

Dimensions



Accessories

TR-UF45-A-IN Dome Indoor Ceiling Mounting Pedestal	TR-SE45-A-IN Dome Ceiling Mounting Pole 500	TR-UC08-B-IN Aluminium Alloy Corner Mounting Bracket
		
TR-UC08-A-IN Dome Corner Mounting Bracket	TR-UP08-B-IN Aluminium Alloy Pole Mounting Bracket	TR-UP08-A-IN Dome Pole Mounting Bracket
		

<p>TR-WE45-B-IN Dome Gooseneck Bracket</p>	<p>TR-JB12-IN Dome Junction Box</p>	<p>TR-WE45-A-IN Long Wall Mounting Bracket for Dome</p>
		
<p>TR-CE45-IN Dome Indoor Ceiling Mounting Bracket</p>	<p>TR-SE45-IN Dome Ceiling Mounting Pole 200</p>	
		

Unlimited New View

Zhejiang Uniview Technologies Co., Ltd.



<http://www.uniview.com>



overseasbusiness@uniview.com; globalsupport@uniview.com



No. 369, Xietong Road, Xixing Sub-district, Binjiang District, Hangzhou City, 310051, Zhejiang Province, China



©2023-2025 Zhejiang Uniview Technologies Co., Ltd. All rights reserved.

*Product specifications and availability are subject to change without notice.

Despite our best efforts, technical or typographical errors may exist in this document. Uniview cannot be held responsible for any such errors and reserves the right to change the contents of this document without prior notice.