

Outdoor Network PTZ Dome Cameras

Quick Guide

V2.00

Waterproof Requirements

Please waterproof cables in accordance with the following instructions. User shall assume all responsibility for device damage caused by water due to improper waterproof measures.



NOTE!

- Before you start, connect all the needed cables and cut off the copper wires for the cables that you don't use.
- Please use self-adhesive waterproof tape (supplied with some products) to protect the cables.
- Use waterproof components to protect the network cable. Waterproof the power cable separately if you don't use it. The video cable does not need waterproof treatment.

1. Use insulation tape (not included in the package) to insulate the connection part of each cable.

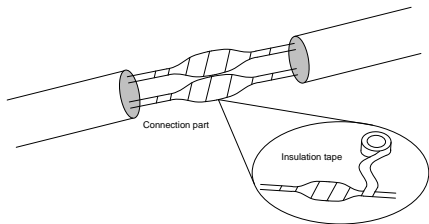

2. Waterproof the cables with self-adhesive waterproof tape.
 - (1) Fully stretch the waterproof tape at both ends.
 - (2) Wrap the connection part and the cable ends tightly with waterproof tape. Make sure the tape is fully stretched during the process.
 - (3) Tighten the tape at both ends to prevent water leakage.



Wrap the used cables separately

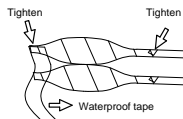

Wrap the unused cables together into a bundle

3. Install the supplied waterproof components to the network cable in sequence.

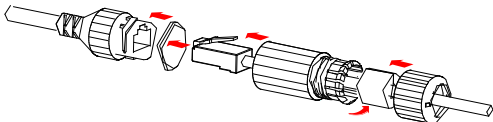

i CAUTION!

You need to mount the rubber ring onto the network cable interface first.

4. If your camera has a DC cable and you will not use it, insert the plug into the interface.

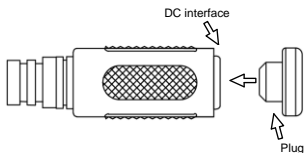

5. (Optional) After the waterproof treatment is completed, put the cables into a waterproof junction box (purchased separately).

i CAUTION!

- The cable connector must not be exposed and must be kept away from water.
- Restore and fasten the device after dismantling.
- Place the power adapter in a power distribution box.

1 Packing List

Contact your local dealer if the package is damaged or incomplete. The package contents may vary with device model.

No.	Name	Qty	Unit
1	Camera	1	PCS
2	Power adapter	1	PCS
3	User manual	1	Set
4*	Cable unit	1	PCS
5*	Cable unit sun shield	1	PCS
6*	ESD-preventive glove	1	Set
7*	Bracket adapter ring	1	PCS
8*	Waterproof components	1	Set

Remarks:

* means optional and supplied with certain models only.

2 Safety and Compliance information

2.1 Installation

- Use a power adapter or a PoE device that meets requirements. Otherwise, the device may be damaged.
- Make sure the length of the power cable between the power adapter and the camera is not too long, otherwise the voltage of the camera is lowered, causing the camera to work abnormally. If it is required to lengthen the power cable, lengthen the cable between the power adapter and the mains.
- Do not hold the tail cable by hand for weight bearing. Otherwise, the cable connector of the camera could be loosened.
- When connecting to an external interface, use an existing connection terminal, and ensure that the cable terminal (latch or clamp) is in good condition and properly fastened. Ensure that the cable is not tense during mounting, with a proper margin reserved to avoid poor port contact or loosening caused by shock or shake.

- During the process of transportation, special attention is required for the protection of the transparent dome cover to prevent friction, scratch and contamination, etc. In order to keep the cover clean, do not remove the protective film on the cover during mounting. After mounting is finished, remove the film before the device is powered on.

2.2 Maintenance

- Caution: There will be risk of explosion if battery is replaced by an incorrect type. Dispose of used batteries according to the instructions.
- If there is dust on the front glass surface, remove the dust gently using an oil-free brush or a rubber dust blowing ball.
- If there is grease or a dust stain on the front glass surface, clean the glass surface gently from the center outward using lens cleaning cloth. If the grease or the stain still cannot be removed, use lens cleaning cloth dipped with detergent and clean the glass surface gently until it is removed.
- Do not use organic solvents, such as benzene or ethanol when cleaning the transparent dome cover.

2.3 Laser Safety (if applicable)

- Installation and maintenance must be carried out by trained and qualified personnel.
- The camera must be mounted at least 6 meters above the ground.
- To avoid the risk of fire, the laser illuminator must be clear of obstacles within a minimum range of 30 centimeters.
- Make sure laser is disconnected from power before examination.
- Never stare into beam or view through any optical instruments. Avoid exposure to direct or scattered radiation. Be especially cautious during installation and maintenance.
- Never view lasers without protective eyewear. Some lasers emit infrared or ultraviolet, which are invisible to human eyes.
- Keep flammable or explosive objects away from laser beam. Some lasers may ignite combustible materials and thus cause fire.
- Never direct laser at a person. Do not direct laser at glass. The reflection may still cause harm to human eyes.
- Make sure the lens cleaning cloth is clean itself.



- Never look at the transmit laser while the power is on. Never look directly at the fiber ports and the fiber cable ends when they are powered on.
- Use of controls or adjustments to the performance or procedures other than those specified herein may result in hazardous laser emissions.

3 Appearance

3.1 Dimensions

The appearance may vary with device model. The following part shows an example.

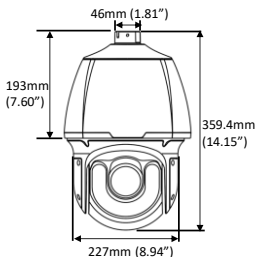

NOTE!

Please refer to the latest product datasheet for detailed specifications.

3.2 Cable Connection

The tail cable may vary with device model. The following part shows an example.



NOTE!

Please refer to the latest product datasheet for detailed specifications.

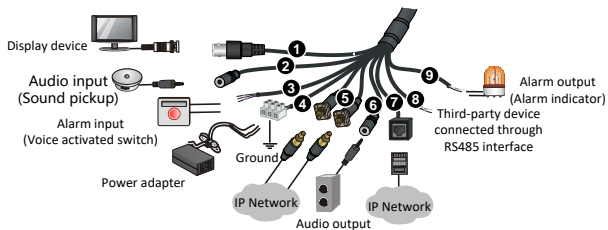

No.	Interface	Usage
1	VIDEO OUT	Video output. Output analog video signal to display device.
2	AUDIO IN	Audio input. NOTE! This interface can be used for audio input and two-way audio, but it cannot be used for the two functions at the same time.
3	ALARM IN	Alarm input.
4	Power interface	Connect power adapter. NOTE! When using, please ensure the device is properly grounded.
5	Optical interface	FC (supplied with flange), 1*100M/1000M Base-FX optical interface (SFP). Connect optical network. NOTE! Optical interface uses single-mode fiber. See (Optional) Mount SFP Optical Module for details.
6	AUDIO OUT	Audio output.
7	Ethernet interface	RJ45, 1*10M/100M Base-TX Ethernet interface. Connect Ethernet network. NOTE!

		Please refer to the latest product datasheet for detailed specifications.
8	RS485	Serial port. Connect external devices for communication, for example, to control third-party devices.
9	ALARM OUT	Alarm output.

4 Installation

4.1 Process Map

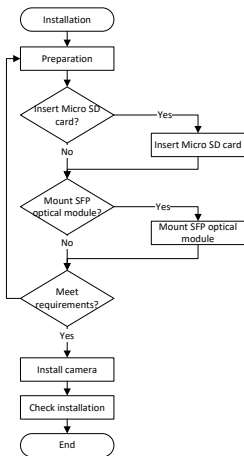

4.2 Preparation

1. Installation position

The bearing capacity of installation position shall meet requirements. Reinforce the installation position if necessary.

2. Lightning protection and grounding requirements

Select proper lightning protection devices for the power supply, audio and video cables, and RS485 cables.

3. Accessories

Accessories such as wall mount bracket will be used during installation. Please choose the accessories according to our recommendation list.



NOTE!

The wall bearing capacity and the bracket length shall meet requirements. Choose an appropriate mounting mode according to the actual situations.

4.3 (Optional) Insert Micro SD Card

You need to install a Micro SD card first if you want to save video on an on-board SD card.



NOTE!

- You need to format the Micro SD card before use. The Micro SD card can be formatted on the camera's Web interface.
 - For recommended SD card specifications, please contact your dealer or technical support.
-

The figure below is for illustrative purpose only. The actual card slot position may vary.



WARNING!

- Before you insert or remove the Micro SD card, be sure to disconnect power and wait till the camera stops operation; otherwise, the camera or the Micro SD card may be damaged.
 - Do not disassemble the device in high humidity environment. The high humidity inside the device will cause lens fogging.
-

1. Remove the 4 screws on the back cover.
2. Insert the micro SD card into the slot.
3. Check that the sealing ring is in position.
4. Put the back cover back in place, and turn the screws until they are fully tightened.

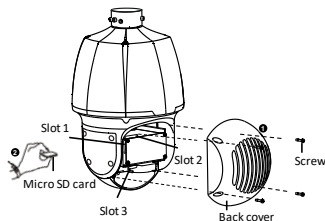

4.4 (Optional) Mount SFP Optical Module

4.4.1 Precautions

- Single-mode fiber rather than multimode fiber should be used as transmission lines.
- The optical module in the camera must match that of the switch in terms of fiber mode, and emission/receiver wavelength. And it shall support a transmission distance longer than the actual distance.
- Select a high quality optical fiber connector. A non-standard unpolished connector may damage the internal ceramic sleeves of optical module, flange or optical splitter.
- You can switch network interface without disconnecting power, but optical interface and Ethernet interface cannot be used at the same time.
- Before connecting optical fiber, check that there is no obvious surface defect such as stain, scratch, dent, or pit. If the fiber connector, flange, or optical module is dirty, clean it with alcohol and clean cotton (or a clean cotton swab).
- When connecting optical module, the curvature of optical fiber cannot be smaller than 90 degrees. If the optical fiber is too long, you can bend the fiber. Ensure that the bend diameter is greater than 60mm, and the curvature is greater than 90 degrees.
- When mounting the tail cable adapter, ensure that the optical fiber is not clamped by the device. Otherwise, the optical fiber may be damaged.
- Ensure that the fiber connector is in good condition, the latch is not disrupted and keeps elasticity, and that the connector is properly connected to the fiber end.
- To connect a fiber connector and a flange, align the fiber connector with the slot in the flange to ensure proper interconnection.

4.4.2 Mount the Optical Module

1. Unscrew the tail cable adapter by loosening the four screws.

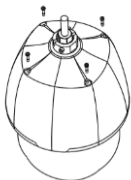

2. Remove the dustproof cover inside the tail cable adapter.

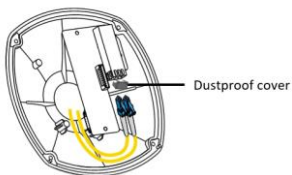

3. Insert the recommended SFP optical module.

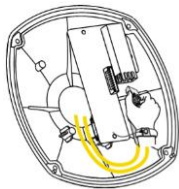

4. Connect the optical fiber and the optical module, and then mount the tail cable adapter back in place.

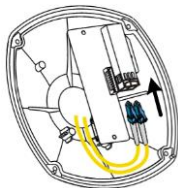

Caution:

Make sure to connect the optical fiber to the optical interface of device tail cable correctly.

4.5 Wall Mount

1. Mark the positions of the holes by referring to the mount points on the bracket and lead the cable through the hole on the wall. Then
2. Turn the bracket adapter (G1 ½ male thread) in and secure the bracket adapter with a screw.

drill holes and knock in the expansion bolts.

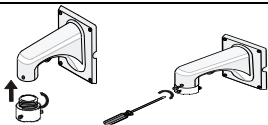
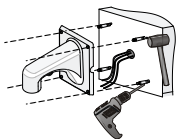

3. Attach the safety wire to the bracket and the dome. And Lead the tail cable through the bracket.



4. Attach the dome to the bracket adapter.

Align the two camera holders on camera top with the inner track on the bracket adapter, push the camera up, and then turn the camera anti-clockwise until it makes contact with the bracket adapter screw.

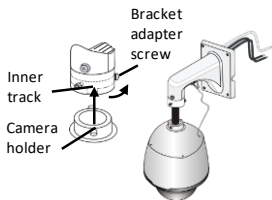

5. Secure the dome with two M5 screws.

6. Connect the cables and attach the bracket to the wall with flat washers, spring washers and nuts.

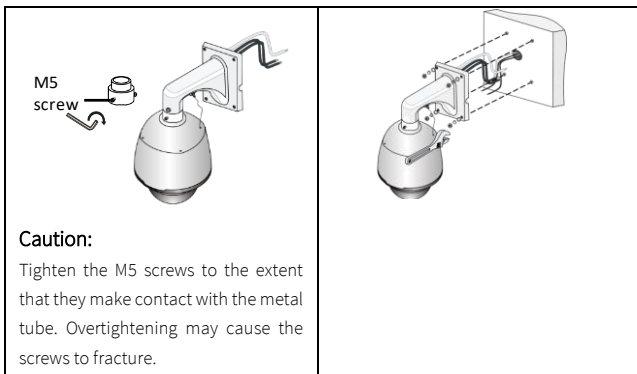

NOTE!

- When mounting the camera, please install the bracket adapter to the bracket first and then mount the camera to the bracket.
- Tighten all the screws to hold the dome securely.
- For waterproofing, apply sealant on the connection part between the dome and the bracket, wall veneer slits, and cable outlets on the wall.
- In the preceding method, the tail cables pass through the wall, if you do not want the cables pass through the wall, pass the cables through the cable outlets on the base.

5 Startup

Check that the device is properly installed, then connect power to start up the device.

The camera performs a self-test every time it's powered on, including each of the pan, tilt and zoom operations. Please wait till the device completes self-test before you operate the camera.



NOTE!

If ambient temperature is below 0°C, the camera will preheat itself automatically before self test. The preheating takes a while (30 minutes at most). Please wait patiently.

6 Web Login

Log in to the Web interface to manage and maintain the device.

1. Open your browser, input the camera's IP address **192.168.1.13** in the address bar and then press Enter to open the login page.
2. Enter the username and password (**admin/123456** by default) and then click **Login**.



NOTE!

- DHCP is enabled by default. If a DHCP server is deployed in the network, the IP address of your camera may be assigned dynamically, and you need to use the assigned IP address to log in.
- If prompted, install the plug-in at your first login. Please follow the on-screen instructions to complete the installation and then open the browser again to log in.
- The default password is intended only for your first login. To ensure security, please change the password after your first login. You are strongly recommended to set a strong password of at least nine characters including all three elements: digits, letters and special characters.
- If the password has been changed, please use the new password to log in.

7 FAQ

1. The system does not prompt me to install the plug-in at my first login on Windows 7.

Answer: Follow the steps to turn off UAC on your computer: Open the Control Panel. Type **uac** in the search box, and then click **Change User Account Control Settings**. Drag the slider to **Never Notify** and then click **OK**. After UAC is turned off, please log in again.

2. Failed to install the plug-in?

Answer: Before you log in, follow the steps to add the camera's IP to the trusted sites in your IE: Click **Tool > Internet Options > Security**. Click **Trusted sites**, click **Sites**, and then add the camera's IP address.

If you are using Windows 7, you also need to save the setup.exe to your computer first, and then right-click the file and select **Run as administrator**.

3. No live video after my first login?

Answer: Please turn off the firewall on your computer and then log in again.

4. How to restore factory default settings?

Answer: Perform the following operations in 10 minutes after the camera is powered on:

- (1) Remove the back cover.
- (2) Press and hold the RST button for at least 10 seconds to restore defaults.

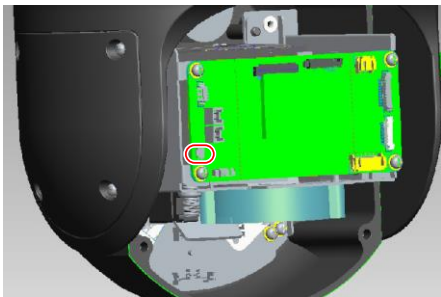

- (3) Wait for the camera to restart.

Disclaimer and Safety Warnings

Copyright Statement

©2021–2024 Zhejiang Uniview Technologies Co., Ltd. All rights reserved.

No part of this manual may be copied, reproduced, translated or distributed in any form or by any means without prior consent in writing from Zhejiang Uniview Technologies Co., Ltd (referred to as Uniview or us hereafter).

The product described in this manual may contain proprietary software owned by Uniview and its possible licensors. Unless permitted by Uniview and its licensors, no one is allowed to copy, distribute, modify, abstract, decompile, disassemble, decrypt, reverse engineer, rent, transfer, or sublicense the software in any form by any means.

Trademark Acknowledgements

All other trademarks, products, services and companies in this manual or the product described in this manual are the property of their respective owners.

Export Compliance Statement

Uniview complies with applicable export control laws and regulations worldwide, including that of the People's Republic of China and the United States, and abides by relevant regulations relating to the export, re-export and transfer of hardware, software and technology. Regarding the product described in this manual, Uniview asks you to fully understand and strictly abide by the applicable export laws and regulations worldwide.

EU Authorised Representative

UNV Technology EUROPE B.V. Room 2945, 3rd Floor, Randstad 21-05 G, 1314 BD, Almere, Netherlands.

Privacy Protection Reminder

Uniview complies with appropriate privacy protection laws and is committed to protecting user privacy. You may want to read our full privacy policy at our website and get to know the ways we process your personal information. Please be aware, using the product described in this manual may involve the collection of personal information such as face, fingerprint, license plate number, email, phone number, GPS. Please abide by your local laws and regulations while using the product.

About This Manual

- This manual is intended for multiple product models, and the photos, illustrations, descriptions, etc, in this manual may be different from the actual appearances, functions, features, etc, of the product.
- This manual is intended for multiple software versions, and the illustrations and descriptions in this manual may be different from the actual GUI and functions of the software.
- Despite our best efforts, technical or typographical errors may exist in this manual. Uniview cannot be held responsible for any such errors and reserves the right to change the manual without prior notice.
- Users are fully responsible for the damages and losses that arise due to improper operation.
- Uniview reserves the right to change any information in this manual without any prior notice or indication. Due to such reasons as product version upgrade or regulatory requirement of relevant regions, this manual will be periodically updated.

Disclaimer of Liability

- To the extent allowed by applicable law, in no event will Uniview be liable for any special, incidental, indirect, consequential damages, nor for any loss of profits, data, and documents.
- The product described in this manual is provided on an "as is" basis. Unless required by applicable law, this manual is only for informational purpose, and all statements, information, and recommendations in this manual are presented without warranty of any kind, expressed

or implied, including, but not limited to, merchantability, satisfaction with quality, fitness for a particular purpose, and noninfringement.

- Users must assume total responsibility and all risks for connecting the product to the Internet, including, but not limited to, network attack, hacking, and virus. Uniview strongly recommends that users take all necessary measures to enhance the protection of network, device, data and personal information. Uniview disclaims any liability related thereto but will readily provide necessary security related support.
- To the extent not prohibited by applicable law, in no event will Uniview and its employees, licensors, subsidiary, affiliates be liable for results arising out of using or inability to use the product or service, including, not limited to, loss of profits and any other commercial damages or losses, loss of data, procurement of substitute goods or services; property damage, personal injury, business interruption, loss of business information, or any special, direct, indirect, incidental, consequential, pecuniary, coverage, exemplary, subsidiary losses, however caused and on any theory of liability, whether in contract, strict liability or tort (including negligence or otherwise) in any way out of the use of the product, even if Uniview has been advised of the possibility of such damages (other than as may be required by applicable law in cases involving personal injury, incidental or subsidiary damage).
- To the extent allowed by applicable law, in no event shall Uniview's total liability to you for all damages for the product described in this manual (other than as may be required by applicable law in cases involving personal injury) exceed the amount of money that you have paid for the product.

Network Security

Please take all necessary measures to enhance network security for your device.

The following are necessary measures for the network security of your device:

- **Change default password and set strong password:** You are strongly recommended to change the default password after your first login and set a strong password of at least nine characters including all three elements: digits, letters and special characters.
- **Keep firmware up to date:** It is recommended that your device is always upgraded to the latest version for the latest functions and better security. Visit Uniview's official website or contact your local dealer for the latest firmware.

The following are recommendations for enhancing network security of your device:

- **Change password regularly:** Change your device password on a regular basis and keep the password safe. Make sure only the authorized user can log in to the device.
- **Enable HTTPS/SSL:** Use SSL certificate to encrypt HTTP communications and ensure data security.
- **Enable IP address filtering:** Allow access only from the specified IP addresses.
- **Minimum port mapping:** Configure your router or firewall to open a minimum set of ports to the WAN and keep only the necessary port mappings. Never set the device as the DMZ host or configure a full cone NAT.
- **Disable the automatic login and save password features:** If multiple users have access to your computer, it is recommended that you disable these features to prevent unauthorized access.

- **Choose username and password discretely:** Avoid using the username and password of your social media, bank, email account, etc, as the username and password of your device, in case your social media, bank and email account information is leaked.
- **Restrict user permissions:** If more than one user needs access to your system, make sure each user is granted only the necessary permissions.
- **Disable UPnP:** When UPnP is enabled, the router will automatically map internal ports, and the system will automatically forward port data, which results in the risks of data leakage. Therefore, it is recommended to disable UPnP if HTTP and TCP port mapping have been enabled manually on your router.
- **SNMP:** Disable SNMP if you do not use it. If you do use it, then SNMPv3 is recommended.
- **Multicast:** Multicast is intended to transmit video to multiple devices. If you do not use this function, it is recommended you disable multicast on your network.
- **Check logs:** Check your device logs regularly to detect unauthorized access or abnormal operations.
- **Physical protection:** Keep the device in a locked room or cabinet to prevent unauthorized physical access.
- **Isolate video surveillance network:** Isolating your video surveillance network with other service networks helps prevent unauthorized access to devices in your security system from other service networks.

Learn More

You may also obtain security information under Security Response Center at Uniview's official website.

Safety Warnings

The device must be installed, serviced and maintained by a trained professional with necessary safety knowledge and skills. Before you start using the device, please read through this guide carefully and make sure all applicable requirements are met to avoid danger and loss of property.

Storage, Transportation, and Use

- Store or use the device in a proper environment that meets environmental requirements, including and not limited to, temperature, humidity, dust, corrosive gases, electromagnetic radiation, etc.
- Make sure the device is securely installed or placed on a flat surface to prevent falling.
- Unless otherwise specified, do not stack devices.
- Ensure good ventilation in the operating environment. Do not cover the vents on the device. Allow adequate space for ventilation.
- Protect the device from liquid of any kind.
- Make sure the power supply provides a stable voltage that meets the power requirements of the device. Make sure the power supply's output power exceeds the total maximum power of all the connected devices.
- Verify that the device is properly installed before connecting it to power.
- Do not remove the seal from the device body without consulting Uniview first. Do not attempt to service the product yourself. Contact a trained professional for maintenance.
- Always disconnect the device from power before attempting to move the device.

- Take proper waterproof measures in accordance with requirements before using the device outdoors.

Power Requirements

- Install and use the device in strict accordance with your local electrical safety regulations.
- Use a UL certified power supply that meets LPS requirements if an adapter is used.
- Use the recommended cordset (power cord) in accordance with the specified ratings.
- Only use the power adapter supplied with your device.
- Use a mains socket outlet with a protective earthing (grounding) connection.
- Ground your device properly if the device is intended to be grounded.

Battery Use Caution

- When battery is used, avoid:
 - Extremely high or low temperature and air pressure during use, storage and transportation.
 - Battery replacement.
- Use the battery properly. Improper use of the battery such as the following may cause risks of fire, explosion or leakage of flammable liquid or gas.
 - Replace battery with an incorrect type.
 - Dispose of a battery into fire or a hot oven, or mechanically crushing or cutting of a battery.
- Dispose of the used battery according to your local regulations or the battery manufacturer's instructions.

Avertissement de l'utilisation de la batterie

- Lorsque utiliser la batterie, évitez:
 - Température et pression d'air extrêmement élevées ou basses pendant l'utilisation, le stockage et le transport.
 - Remplacement de la batterie.
- Utilisez la batterie correctement. Mauvaise utilisation de la batterie comme celles mentionnées ici, peut entraîner des risques d'incendie, d'explosion ou de fuite liquide de gaz inflammables.
 - Remplacer la batterie par un type incorrect.
 - Disposer d'une batterie dans le feu ou un four chaud, écraser mécaniquement ou couper la batterie.
- Disposer la batterie utilisée conformément à vos règlements locaux ou aux instructions du fabricant de la batterie.
- **Personal safety warnings:**
 - Chemical Burn Hazard. This product contains a coin cell battery. Do NOT ingest the battery. It can cause severe internal burns and lead to death.
 - Keep new and used batteries away from children.
 - If the battery compartment does not close securely, stop using the product and keep it away from children.
 - If you think batteries might have been swallowed or placed inside any part of the body, seek immediate medical attention.
- **Avertissements de sécurité personnelle:**
 - Risque de brûlure chimique. Ce produit contient une batterie de cellules. N'ingérer pas la batterie. Si la batterie de cellule est avalée, elle peut causer de graves brûlures internes en seulement 2 heures et peut entraîner la mort.

- Gardez les batteries nouvelles ou utilisées à l'écart des enfants.
- Si le compartiment de la batterie ne se ferme pas en toute sécurité, cessez d'utiliser le produit et gardez-le à l'écart des enfants.
- Si vous pensez que des piles ont pu être avalées ou placées à l'intérieur d'une partie du corps, consultez immédiatement un médecin.

Regulatory Compliance

FCC Statements

This device complies with Part 15 of the FCC Rules. Operation is subject to the following two conditions: (1) this device may not cause harmful interference, and (2) this device must accept any interference received, including interference that may cause undesired operation.

Visit http://en.uniview.com/Support/Download_Center/Product_Installation/Declaration/ for SDoC.

Caution: The user is cautioned that changes or modifications not expressly approved by the party responsible for compliance could void the user's authority to operate the equipment.

NOTE: This equipment has been tested and found to comply with the limits for a Class A digital device, pursuant to part 15 of the FCC Rules. These limits are designed to provide reasonable protection against harmful interference when the equipment is operated in a commercial environment. This equipment generates, uses, and can radiate radio frequency energy and, if not installed and used in accordance with the instruction manual, may cause harmful interference to radio communications. Operation of this equipment in a residential area is likely to cause harmful interference in which case the user will be required to correct the interference at his own expense.

LVD/EMC Directive



This product complies with the European Low Voltage Directive 2014/35/EU and EMC Directive 2014/30/EU.

WEEE Directive-2012/19/EU



The product this manual refers to is covered by the Waste Electrical & Electronic Equipment (WEEE) Directive and must be disposed of in a responsible manner.

Battery Regulation- (EU) 2023/1542



Battery in the product complies with the European Battery Regulation- (EU) 2023/1542. For proper recycling, return the battery to your supplier or to a designated collection point.