

Intelligent Integrated Management BOX Quick Guide

V1.01

Preface

The content of this section is designed to ensure that users use the product correctly to prevent dangers or property loss caused by improper operation. Before using this product, be sure to read this manual carefully. Please keep this manual properly for future reference.

About This Manual

- We recommend that you use this manual under the guidance of a professional.
- This manual is designed for use with multiple product models, and it is not possible to list the appearance and functions of each product individually. Please refer to the actual product for use.
- This manual is intended for multiple software versions, and the illustrations and descriptions in this manual may be different from the actual GUI and functions of the software.
- Despite our best efforts, technical or typographical errors may exist in this manual. Uniview cannot be held responsible for any such errors and reserves the right to change the manual without prior notice.
- Users are fully responsible for the damages and losses that arise due to improper operation.
- Uniview reserves the right to change any information in this manual without any prior notice or indication. Due to such reasons as product version upgrade or regulatory requirement of relevant regions, this manual will be periodically updated.
- This manual will be updated in real time according to the laws and regulations of the relevant regions. For specific details, please refer to the product's paper copy, QR code, or official website. In case of any discrepancy between the paper copy and the electronic version, the electronic version shall prevail.

About This Product

If the product you have chosen is a video product, please strictly adhere to the applicable laws and regulations. You can visit our official website to inquire about the relevant content.

Instructions for Use

- This document serves as a guide for use only. All statements, information, and suggestions contained in this document do not constitute any express or implied warranty.
- We assume no responsibility for any special, incidental, consequential, or indirect damages resulting from the use of this manual or the use of our products, including but not limited to losses due to loss of business profits, data or document loss, and product malfunction or information leakage caused by cyber-attack, hacker attack, and virus infections.
- Due to uncertain factors such as the physical environment, there may be discrepancies between the actual values of some data and the reference values provided in the manual. In case of any questions or disputes, the company's final interpretation shall prevail.



Formatting Conventions

The UI formatting conventions used in this document are as follows:

Format	Meaning
Bold	Bold means UI elements (button names, menu names, window names, etc.), e.g., Click Save .
>	Indicate a sequence of actions, e.g., click Device Management > Add Device, which means first click Device Management, and then click Add Device.

Symbol Conventions

This document uses various distinctive symbols to highlight areas that require special attention during the operation process. The meanings of these symbols are as follows:

Symbol	Meaning
	NOTE: Provides tips and additional information related to the operation and use of the product.
	CAUTION: Alerts to matters that requires attention during operation, as improper handling may lead to product damage, data loss, or functional abnormalities.
	WARNING: The annotations following this symbol demand extra attention, as improper handling could potentially cause personal injury.

Legal Statement

Copyright Statement

©2025-2026 Zhejiang Uniview Technologies., Co., Ltd. All rights reserved.

All parts of this document, including but not limited to text, images, and graphics, are copyrighted and belong to Zhejiang Uniview Technologies Co., Ltd (hereinafter referred to as "Uniview" "we" "us"). Without our written permission, no organization or individual may excerpt, copy, translate, modify, or disseminate any part or all of the content of this manual in any form. The products described in this manual may contain software copyrighted by us and any potential licensors. Without the permission of the relevant rights holders, no one may copy, distribute, modify, excerpt, decompile, disassemble, decrypt, reverse engineer, rent, transfer, sublicense, or engage in any other actions that infringe upon the software copyright in any form.

Trademark Acknowledgements

 are trademarks or registered trademarks of Uniview.

All other trademarks, products, services and companies in this manual or the product described in this manual are the property of their respective owners.

Export Compliance Statement

Uniview complies with applicable export control laws and regulations worldwide, including that of the People's Republic of China and the United States, and abides by relevant regulations relating to the export, re-export and transfer of hardware, software and technology. Regarding the product described in this manual, Uniview asks you to fully understand and strictly abide by the applicable export laws and regulations worldwide.

EU Authorised Representative

UNV Technology EUROPE B.V. Treubstraa 1, 2288 EG, Rijswijk, Netherlands.

If you have any feedback, please contact us at service@uniview.com.

Disclaimer of Liability

- We assume no responsibility and offer no compensation for any special, incidental, consequential, or indirect damages resulting from the use of this manual or our products, including but not limited to losses related to lost business profits, data, or document loss.
- The product described in this manual is provided on an "as is" basis. Unless required by applicable law, this manual is only for informational purpose, and all statements, information, and recommendations in this manual are presented without warranty of any kind, expressed or implied, including, but not limited to, merchantability, satisfaction with quality, fitness for a particular purpose, and noninfringement.
- Users must assume total responsibility and all risks for connecting the product to the Internet, including, but not limited to, network attack, hacking, and virus. Uniview strongly recommends that users take all necessary measures to enhance the protection of network, device, data and personal information. Uniview disclaims any liability related thereto but will readily provide necessary security related support.
- To the extent not prohibited by applicable law, in no event will Uniview and its employees, licensors, subsidiary, affiliates be liable for results arising out of using or inability to use the product or service, including, not limited to, loss of profits and any other commercial damages or losses, loss of data, procurement of substitute goods or services; property damage, personal injury, business interruption, loss of business information, or any special, direct, indirect, incidental, consequential, pecuniary, coverage, exemplary, subsidiary losses, however caused and on any theory of liability, whether in contract, strict liability or tort (including negligence or otherwise) in any way out of the use of the product, even if Uniview has been advised of the possibility of such damages (other than as may be required by applicable law in cases involving personal injury, incidental or subsidiary damage).
- To the extent allowed by applicable law, in no event shall Uniview's total liability to you for all damages for the product described in this manual (other than as may be required by applicable law in cases involving personal injury) exceed the amount of money that you have paid for the product.
- When using this product, please strictly adhere to the applicable laws and regulations to avoid infringing upon the rights of third parties, including but not limited to intellectual property rights, data rights, or other privacy rights. You must also not use this product for the purposes of developing or facilitating the use of weapons of mass destruction, biological or chemical weapons, nuclear weapons, or for any other purposes that violate international norms and regulations.

Privacy Protection Reminder

Uniview complies with appropriate privacy protection laws and is committed to protecting user privacy. You may want to read our full privacy policy at our website and get to know the ways we process your personal information. Please be aware, using the product described in this manual may involve the collection of personal information such as face, fingerprint, license plate number, email, phone number, GPS. Please abide by your local laws and regulations while using the product.

Safety Precautions

The device must be installed, serviced and maintained by a trained professional with necessary safety knowledge and skills. Before you start using the device, please read through this guide carefully and make sure all applicable requirements are met to avoid danger and loss of property.

Storage, Transportation, and Use

- Store or use the device in a proper environment that meets environmental requirements, including and not limited to, temperature, humidity, dust, corrosive gases, electromagnetic radiation, etc.
- Make sure the device is securely installed or placed on a flat surface to prevent falling.
- Unless otherwise specified, do not stack devices.
- Ensure good ventilation in the operating environment. Do not cover the vents on the device. Allow adequate space for ventilation.
- Protect the device from liquid of any kind.
- Make sure the power supply provides a stable voltage that meets the power requirements of the device. Make sure the power supply's output power exceeds the total maximum power of all the connected devices.
- Verify that the device is properly installed before connecting it to power.
- Do not remove the seal from the device body without consulting Uniview first. Do not attempt to service the product yourself. Contact a trained professional for maintenance.
- Always disconnect the device from power before attempting to move the device.
- Take proper waterproof measures in accordance with requirements before using the device outdoors.

Power Requirements

- Install and use the device in strict accordance with your local electrical safety regulations.
- Use a UL certified power supply that meets LPS requirements if an adapter is used.
- Use the recommended cordset (power cord) in accordance with the specified ratings.
- Only use the power adapter supplied with your device.
- Use a mains socket outlet with a protective earthing (grounding) connection.
- Ground your device properly if the device is intended to be grounded.

Battery Safety

Please use batteries properly; otherwise, there is a risk of fire or explosion.

- **Warning:** Using incorrect battery models can lead to explosion.
- If you need to replace the battery, it is recommended that you go to an authorized service center or have it replaced under professional supervision. We shall not be held responsible for any issues arising from unauthorized battery replacement.
- When replacing the battery, be sure to use a battery of the same type as the original! Using the wrong model for replacement (such as certain types of lithium batteries) may cause safety protection to fail.
- Batteries must not be exposed to overheat environments such as sunlight, fire, as this may lead to fire, explosion, or combustion.
- Do not dispose of batteries in fire or heating appliances. Do not squeeze, bend, or cut batteries, as it may cause explosion.
- Do not expose batteries to extremely high or low temperatures, or to very low-pressure environments, as this may cause explosion or leakage of flammable liquid/gas.
- Dispose of the used battery according to your local regulations or the battery manufacturer's instructions.
- For products or the included remote control containing a button cell battery: Do not ingest the battery - chemical burn hazard! If swallowed, a button cell battery can cause severe internal burns within 2 hours and may be fatal. Precautions (including but not limited to):
 - Keep new and used batteries away from children.
 - Stop using the product and keep it away from children if the battery compartment is not securely closed.
 - If you suspect that a battery may have been swallowed or inserted inside any part of the body, seek immediate medical attention.

Network Security

Please take all necessary measures to enhance network security for your device.

The following are necessary measures for the network security of your device:

- **Change default password and set strong password:** You are strongly recommended to change the default password after your first login and set a strong password of at least nine characters including all three elements: digits, letters and special characters.
 - Do not include the account name or the reverse of the account name.
 - Avoid using consecutive characters, such as 123, abc, etc.
 - Do not use overlapping characters, such as 111, aaa, etc.
- **Keep firmware up to date:** It is recommended that your device is always upgraded to the latest version for the latest functions and better security. Visit Uniview's official website or contact your local dealer for the latest firmware.

The following are recommendations for enhancing network security of your device:

- **Change password regularly:** Change your device password on a regular basis and keep the password safe. Make sure only the authorized user can log in to the device.
- **Enable HTTPS/SSL:** Use SSL certificate to encrypt HTTP communications and ensure data security.
- **Enable IP address filtering:** Allow access only from the specified IP addresses.

- **Minimum port mapping:** Configure your router or firewall to open a minimum set of ports to the WAN and keep only the necessary port mappings. Never set the device as the DMZ host or configure a full cone NAT.
- **Disable the automatic login and save password features:** If multiple users have access to your computer, it is recommended that you disable these features to prevent unauthorized access.
- **Choose username and password discretely:** Avoid using the username and password of your social media, bank, email account, etc., as the username and password of your device, in case your social media, bank and email account information is leaked.
- **Restrict user permissions:** If more than one user needs access to your system, make sure each user is granted only the necessary permissions.
- **Disable UPnP:** When UPnP is enabled, the router will automatically map internal ports, and the system will automatically forward port data, which results in the risks of data leakage. Therefore, it is recommended to disable UPnP if HTTP and TCP port mapping have been enabled manually on your router.
- **SNMP:** Disable SNMP if you do not use it. If you do use it, then SNMPv3 is recommended.
- **Multicast:** Multicast is intended to transmit video to multiple devices. If you do not use this function, it is recommended you disable multicast on your network.
- **Check logs:** Check your device logs regularly to detect unauthorized access or abnormal operations.
- **Physical protection:** Keep the device in a locked room or cabinet to prevent unauthorized physical access.
- **Isolate video surveillance network:** Isolating your video surveillance network with other service networks helps prevent unauthorized access to devices in your security system from other service networks.

Learn More

You may also obtain security information under Security Response Center at Uniview's official website.

Avertissement de l'utilisation de la batterie

- Lorsque utiliser la batterie, évitez:
 - Température et pression d'air extrêmement élevées ou basses pendant l'utilisation, le stockage et le transport.
 - Remplacement de la batterie.
- Utilisez la batterie correctement. Mauvaise utilisation de la batterie comme celles mentionnées ici, peut entraîner des risques d'incendie, d'explosion ou de fuite liquide de gaz inflammables.
 - Remplacer la batterie par un type incorrect;
 - Disposer d'une batterie dans le feu ou un four chaud, écraser mécaniquement ou couper la batterie;
- Disposer la batterie utilisée conformément à vos règlements locaux ou aux instructions du fabricant de la batterie.

Regulatory Compliance

FCC Statements

This device complies with Part 15 of the FCC Rules. Operation is subject to the following two conditions: (1) this device may not cause harmful interference, and (2) this device must accept any interference received, including interference that may cause undesired operation.

Visit https://global.uniview.com/Support/Download_Center/Product_Installation/Declaration/ for SDoC.

Caution: The user is cautioned that changes or modifications not expressly approved by the party responsible for compliance could void the user's authority to operate the equipment.

NOTE: This equipment has been tested and found to comply with the limits for a Class A digital device, pursuant to part 15 of the FCC Rules. These limits are designed to provide reasonable protection against harmful interference when the equipment is operated in a commercial environment. This equipment generates, uses, and can radiate radio frequency energy and, if not installed and used in accordance with the instruction manual, may cause harmful interference to radio communications. Operation of this equipment in a residential area is likely to cause harmful interference in which case the user will be required to correct the interference at his own expense.

LVD/EMC Directive



This product complies with the European Low Voltage Directive 2014/35/EU and EMC Directive 2014/30/EU.

WEEE Directive-2012/19/EU



The product this manual refers to is covered by the Waste Electrical & Electronic Equipment (WEEE) Directive and must be disposed of in a responsible manner.

Battery Regulation- (EU) 2023/1542



Battery in the product complies with the European Battery Regulation (EU) 2023/1542. For proper recycling, return the battery to your supplier or to a designated collection point.

1. Packing List

The package contents may vary with box model and version.

No.	Name	Qty	Unit
1	Intelligent Integrated Management BOX (referred to as box hereafter)	1	PCS
2	Box door key	2	PCS
3	Box prefixing bracket (with 2 clamps)	1	Set
4	Clamp	2	PCS
5	Waterproof components	5	Set
6	Warning light	1	PCS
7	M4-10mm cross screw	16	PCS
8	M4-20mm cross screw	16	PCS
9	M3-8mm Phillips screwdriver	4	PCS
10	Hex key	1	PCS
11	M8-10mm hex socket screw	4	PCS
12	M8-20mm hex socket screw	4	PCS
13	Gland	1	PCS
14	Anti-vibration foam	4	PCS
15	Product documents	1	Set

2. Product Overview

The box is an all-in-one solution that integrates power supply, networking, device management, remote maintenance, smart video management, and more. It features high integration, high reliability, ease of maintenance, and simple installation, suitable for construction sites, highways, farms, cities, industrial parks, etc. The box offers AC and DC models for scenarios with or without access to power, installing a 4G router (user-provided) can enable use in wireless network environments.

2.1 Dimensions

The figures below are for illustrative purposes only.

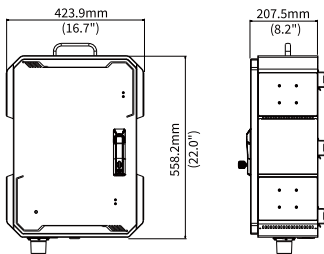

2.2 Structure

Normally, you only need to operate the first layer of the box. The second layer shown here is for reference only during maintenance. See 3.3.1 Door Lock Operation for the steps to open the box door. The actual structure may vary depending on the model.

2.2.1 AC Model

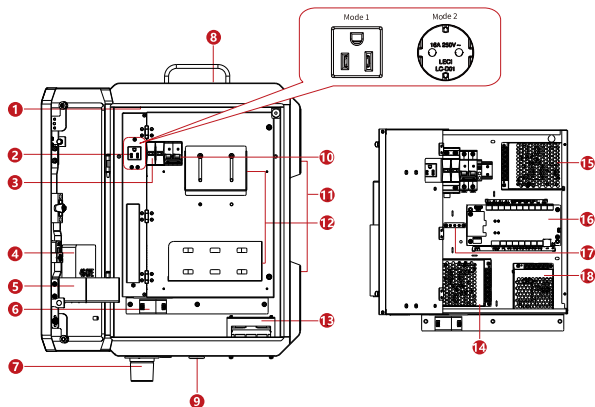

No.	Name	No.	Name
①	Fan	②	Socket
			● Model 1

			<p>Output voltage: AC120V Rated current: 6A</p> <ul style="list-style-type: none"> ● Model 2 <p>Output voltage: AC230V Rated current: 6A</p> <p>Note: Different regions require different models. Please choose the intelligent integrated management box according to your local electrical standards.</p>
③	Circuit breaker	④	<p>4G router (with at least 2 LAN ports reserved)</p> <p>Note: The 4G router is user-provided. Please place it here when the installation is completed.</p>
⑤	Storage box	⑥	Mains wiring terminal
⑦	Warning light	⑧	IP speaker installation hole
⑨	Dome camera mounting plate/IP speaker installation hole	⑩	Surge protector
⑪	Camera junction box mounting hole	⑫	Customer device mounting bracket
⑬	Heater	⑭	Customer device power supply
⑮	Heater power supply	⑯	Power management module
⑰	Grounding terminal	⑱	Power management module, 12V input

2.2.2 DC Model

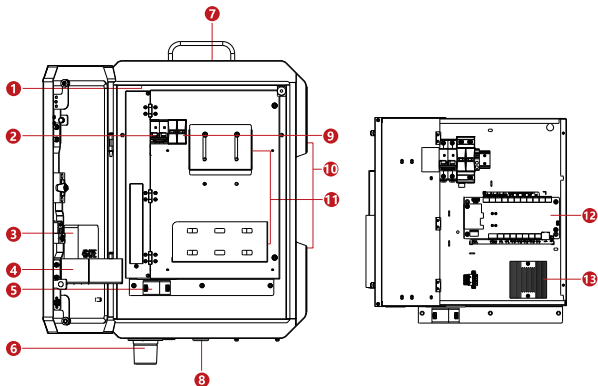

No.	Name	No.	Name
①	Fan	②	Surge protector
③	4G router (with at least 3 LAN ports reserved) Note: The 4G router is user-provided. Please place it here when the installation is completed.	④	Storage box
⑤	DC input wiring terminal	⑥	Warning light
⑦	IP speaker installation hole	⑧	Dome camera mounting plate/IP speaker installation hole
⑨	Circuit breaker	⑩	Camera junction box mounting hole
⑪	Customer device mounting bracket	⑫	Power management module
⑬	Customer device power	-	-

3. Device Installation

3.1 Installation Tools

The following tools will be required during the installation.

- ESD gloves
- Screwdriver

3.2 Lightning Protection

Lightning protection measures must be place when the device is installed at a high place.

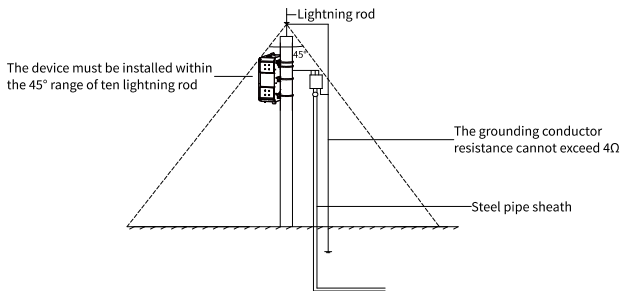

- The device should be installed within the effective range of the lightning rod.
- Outdoor wiring should preferably be routed along the eaves.
- In open areas, sealed steel pipes must be buried for wiring and grounded at a single point. Suspended wiring is strictly prohibited.
- In the case of outdoor installation, please take the necessary protective measures to ensure electrical safety, and install surge protectors as required.
- In areas with severe thunderstorms or high induced voltages (for example, high voltage substations), additional protection devices must be installed, such as high-power lightning protection device, lightning conductor, etc.
- The lightning protection and grounding for outdoor installations and lines must be designed in accordance with the lightning protection requirements of the buildings and must comply with the relevant national and industry standards.

- The system must be connected to a common electrical potential ground. The grounding equipment must meet both the requirements for system interference resistance and electrical safety and must not be short-circuited or mixed with the neutral line of the high-voltage power grid. When the system is grounded separately, the grounding impedance must not exceed 4Ω , and the cross-sectional area of the grounding conductor must be equal to or greater than 25mm^2 .

3.3 Installation



CAUTION!

- Do not place any network device in the box until the box is securely mounted.
 - A clamp can hold a maximum weight of 20kg.
-

3.3.1 Door Lock Operation

1. If the box door is locked, insert the key from the package into the keyhole and rotate it 180° counterclockwise to unlock.

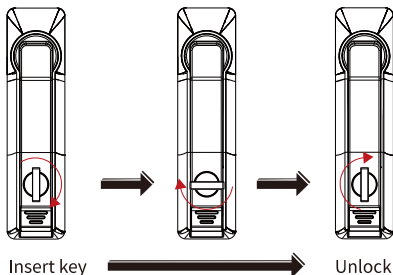

2. After unlocking, be sure to remove the key to prevent it from being accidentally ejected during subsequent operations.

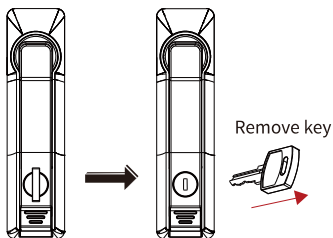

3. Press the switch at the bottom of the lock, then rotate the popped-out door handle 90° clockwise to open the door.

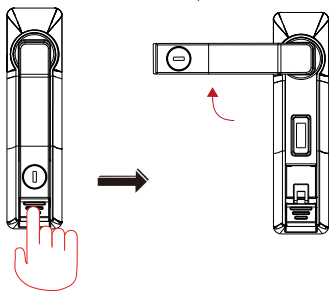

NOTE!

To close and lock the door, reverse the steps and keep the key safe.

3.3.2 Device Installation

1 Warning Light Installation

1. Locate the warning light power cable inside the box at the indicated position. Pass the cable through the bottom warning light mounting hole and connect it to the 2-pin interface at the bottom of the warning light.

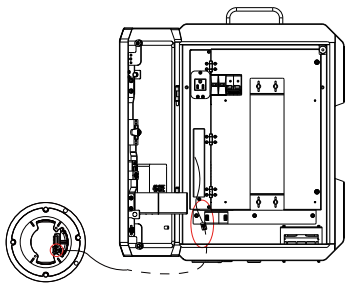

2. Align the silkscreen marks on the warning light with those on the bottom of the box, and secure it using the included M3-8mm cross screws.

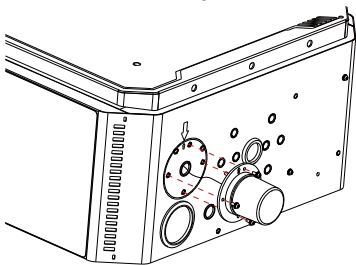

2 (Optional) Customer Device Installation and Power Supply

You can install an NVR or a network switch in the box. Please prepare the device as needed.



CAUTION!

Do not perform operations while powered. Before you perform any operations, ensure the circuit breaker is switched off and all cables are de-energized.

Compatible Dimensions

Supports installation of equipment with dimensions:

Length: 90–225 mm, Width: 0–185 mm, Height: 0–63 mm.

Electrical Specifications

Rated voltage: DC 48 V, rated current: 2.3 A.

Installation Procedure

1. Remove the rectangular anti-vibration foams included in the package and attach them to all four sides of the device as shown in the figure below.

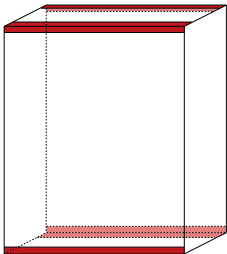

2. Loosen the mounting screws on the triangle bracket, adjust it to the appropriate position, and place the device into the box. If the device is smaller, remove the screws and select suitable screw holes according to the actual size of the device for secure mounting.

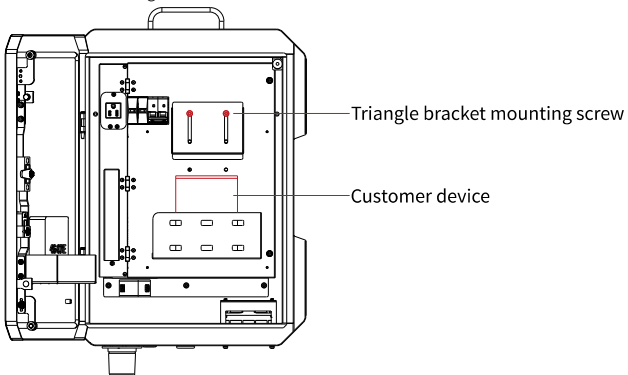

3. Adjust the triangle bracket so it fits snugly against the device, then tighten the screws to secure it in place.

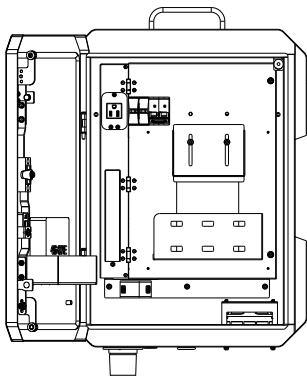

CAUTION!

If necessary, use extra foam padding, cable ties, or other methods for securing.

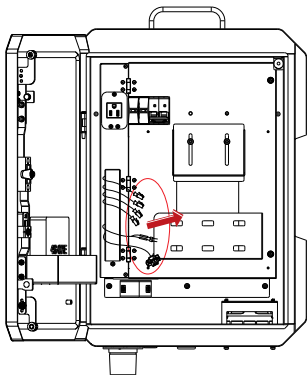

4. Find the internal phoenix terminals, alarm cables, and network cables within the box and connect them to the side of the device.



3 Camera/IP Speaker Installation

The camera, IP speaker, and junction box need to be purchased separately according to actual needs.

CAUTION!

Please use the (M8-20mm) hex socket screws  from the accessory kit to install the camera, and use the (M8-10mm) hex socket screws  to install the speaker.

NOTE!

- Only PoE-powered cameras are supported.
- It is recommended that the cameras installed on both sides of the box have similar weights.

Side mount

1. Check whether the hole diameter and hole spacing at the bottom of the junction box meet the requirements.
 - Model 1 (suitable for fixed dome/turret network camera)

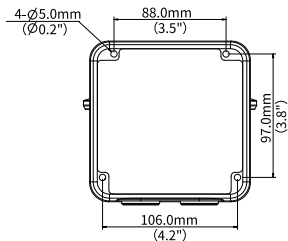

- Model 2 (suitable for bullet/dome network camera)

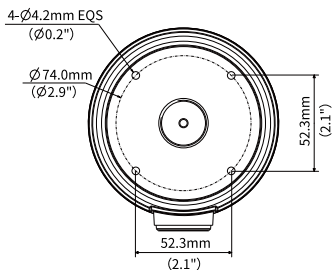

2. Remove the waterproof cover from the side of the box.

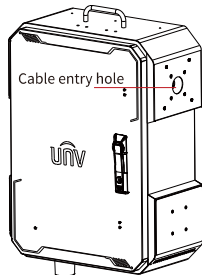
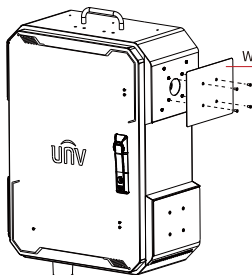

3. Install the camera and connect the network cable to the camera's tail cable. For detailed installation instructions, refer to the corresponding quick guide.

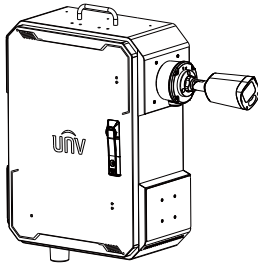
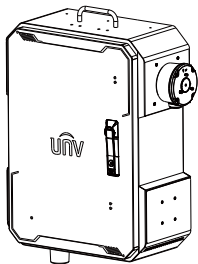

Bottom mount

1. Check whether the hole diameter and hole spacing of the dome camera mounting plate or the IP speaker bracket meets the requirements.

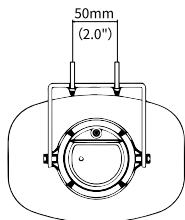
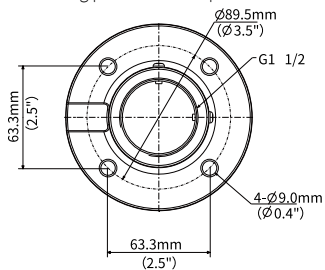

2. Find the installation holes for the cameras/IP speaker.

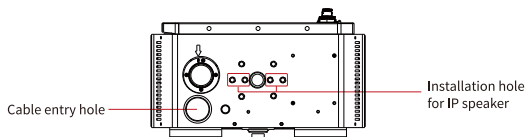
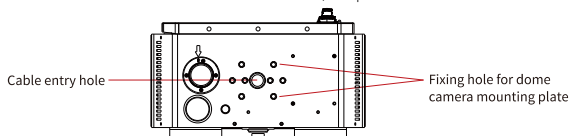

3. Install the camera or IP speaker and connect the network cable to the camera's tail cable. For detailed installation instructions, refer to the corresponding quick guide.

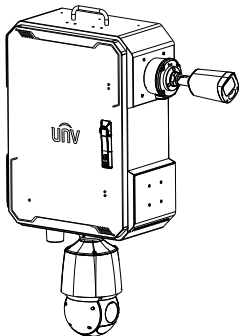

4. Use cable ties to secure the internal cables to the bottom of the box (see the illustration below) to prevent the device's tail cables from touching the heater.

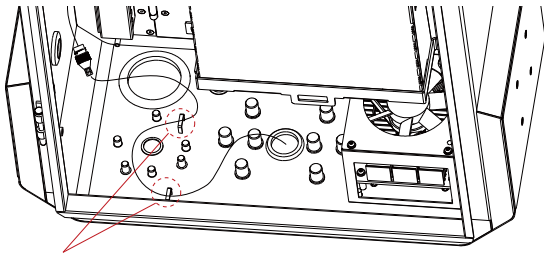

Use cable ties here

Top mount

1. Only IP speakers are supported for top installation, and the mounting bracket requirements are the same as those for bottom mount.
2. Find the corresponding mounting holes for installation. For IP speakers installed on top, the tail cables should still enter the box through the wiring hole at the bottom. The internal wiring method is the same as for bottom installation.

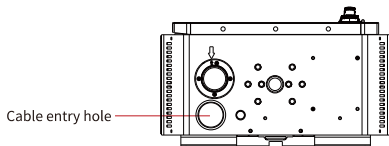
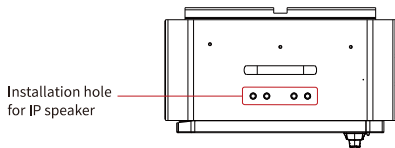

4 Box Installation

1. Secure the prefixing bracket to the pole using a clamp. The maximum supported pole diameter is 300mm.

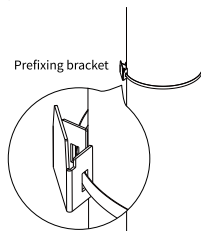

2. Insert the upper reinforcing element on the back of the box into the bracket to complete the prefixing.

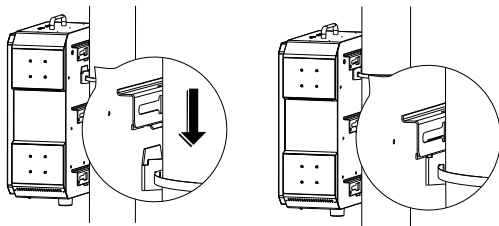

- Use three clamps to secure the upper and lower reinforcing elements to complete the fixing.

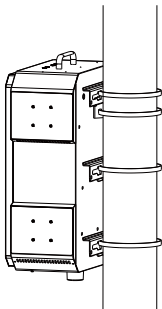

3.4 Network Connection

Choose the appropriate network connection method according to the local network environment.

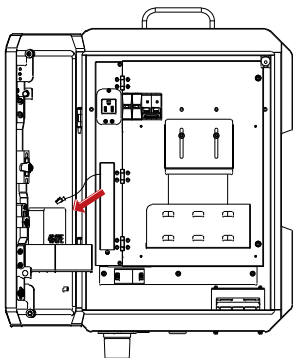

i CAUTION!

The network devices mentioned in the following sections must support a DC12V round-head power supply.

3.4.1 Wireless Network

1. Open the box door, place the 4G router in the storage box located on the inside of the door.
 - AC model: Reserve at least 2 LAN ports on the 4G router.
 - DC model: Reserve at least 3 LAN ports on the 4G router.

i CAUTION!

The selected 4G router must meet the following requirements:

- The box provides 12V/2.5A, with a maximum power not exceeding 30W. The 4G router's power consumption should not exceed this limit.
 - The router's bandwidth must meet the combined bandwidth requirements for the IP cameras (IPCs).
-

2. Connect the network cables from the customer device and the power management module to the 4G router.
3. Locate the cable tagged with ROUTER POWER, and connect it to the 4G router.

3.4.2 Wired Network

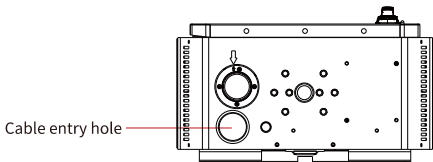

Connect External Fiber Optic Cable

1. Place the fiber modem, optical transceiver, or fiber switch (with RJ45 ports) into the storage box.
 - AC model: Reserve at least 2 RJ45 ports on the network device.
 - DC model: Reserve at least 3 RJ45 ports on the network device.

2. Lead the external fiber optic cable through the cable entry hole at the bottom of the box, and connect it to the network device.
3. Connect network cables of the customer device and the power management module to the network device.
4. Locate the cable tagged with ROUTER POWER, and connect it to the network device.

Connect External Network Cable

1. Place the switch (with RJ45 ports) into the storage box.
 - AC model: Reserve at least 3 RJ45 ports on the switch.
 - DC model: Reserve at least 4 RJ45 ports on the switch.
2. Lead the external network cable through the cable entry hole at the bottom of the box, and connect it to the switch.
3. Connect the network cables of the customer device and the power management module to the switch.
4. Locate the cable tagged with ROUTER POWER, and connect it to the switch.

3.5 Power On



CAUTION!

- Do not operate with power connected. Before operating, ensure that the circuit breaker is in the OFF position, and all cables are de-energized.
 - For the final installation, a UL 489-certified, 20-ampere circuit breaker must be installed at the front end.
-

3.5.1 AC Model

Connect to mains power for supply; install a cable gland if required.



CAUTION!

Voltage range for AC model: AC 100V to 240V.

No Cable Gland

1. Lead the mains supply cables through the cable entry hole. The terminals from left to right on the front panel of the box are Live, Neutral, Ground.
2. After ensuring correct connections, close the circuit breaker. All devices inside the box will be powered.

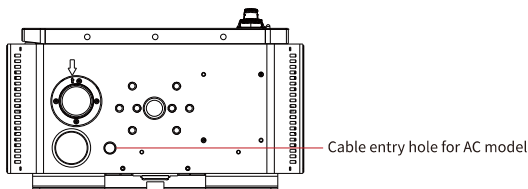

With Cable Gland

1. Remove the rubber ring from the cable entry hole, and lead the cables through the locking nut, main body, mounting hole, washer, and sealing nut in sequence.
2. Crimp the cables at the mains wiring terminal, with Live, Neutral, and Ground arranged from left to right on the front panel of the box.
3. Insert the left side of the main body into the mounting hole in the direction shown in the figure, and fasten the locking nut and sealing nut to the main body.
4. After ensuring correct connections, close the circuit breaker. All devices inside the box will be powered.

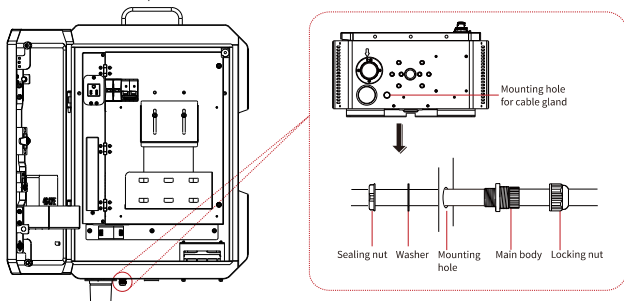

3.5.2 DC Model

Connects to the 12V solar power supply system. The following introduces how to connect the solar power supply system to the box. For precautions regarding the solar power supply system, see the corresponding quick guide.



CAUTION!

Voltage range for DC model: DC 10.8V to 14.4V.

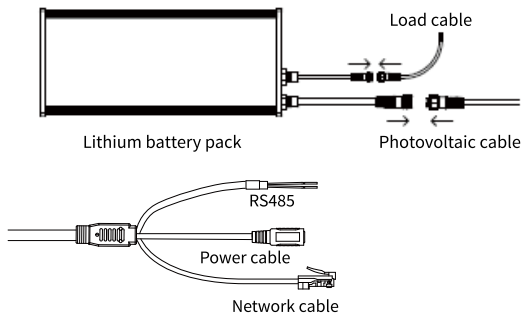

O&M module tail cables

1. Lead the solar cables through the cable entry hole at the bottom of the box.
- Load Cable:
 - Connect the aviation connector to the lithium battery pack's output port.
 - Connect the RS485 terminal to the solar O&M module's RS485 cable.
 - Connect the UT terminal to the DC box's input wiring terminal.

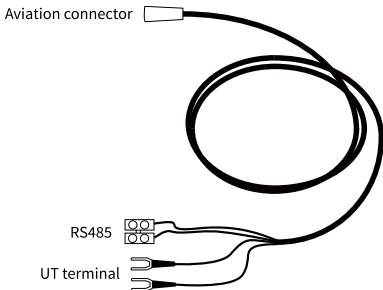

- Adapter Cable:
 - Connect the DC connector to the O&M module power supply.

- Connect the UT terminal to the DC box's input wiring terminal.

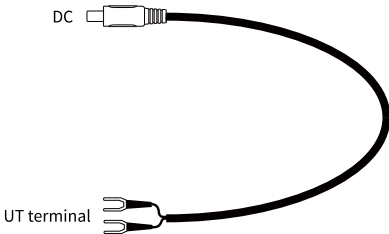

2. Crimp the cables onto the terminal blocks. On the front panel of the box, terminals are arranged from left to right as: + / -.
3. After ensuring correct connections, close the circuit breaker. All devices inside the box will be powered.

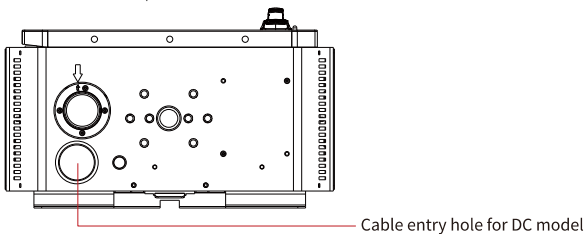

4. Local Web Management

4.1.1 Web Login

Default IP address

192.168.1.13

Default

username/password

admin/123456

Note:

For security, please set a strong password (at least 9 characters, including uppercase and lowercase letters, digits, and special characters) after your first login. It is recommended to change the password regularly and store it securely to ensure that only authorized users can log in to the device.

4.1.2 System Configuration

1 Language Configuration

Set the system language for the device. The default language is English.

The screenshot shows a web interface for system configuration. On the left is a sidebar menu with a gear icon and the word "System". Below it are four menu items: "Language Configuration" (highlighted in blue), "Threshold Configuration", "Box Status and Po...", "Network", and "Maintenance". The main content area is titled "Language Configuration" and contains a "Device Language" dropdown menu set to "English" and a blue "Save" button.

2 Threshold Configuration

Set temperature and humidity alarm thresholds. The following are system default values.

- Low temperature threshold: 41° F / 5° C
- High temperature threshold: 122° F / 50° C
- Humidity threshold: 95%

The screenshot shows the "Threshold Configuration" page. The sidebar menu is the same as in the previous screenshot, with "Threshold Configuration" highlighted. The main content area is titled "Threshold Configuration" and includes a "Temperature Unit" section with radio buttons for "Fahrenheit(°F)" (selected) and "Celsius(°C)". Below this are three input fields: "Low temperature threshold" with the value "41.0" and a unit selector "°F"; "High temperature threshold" with the value "122.0" and a unit selector "°F"; and "Humidity threshold" with the value "95" and a unit selector "%". A blue "Save" button is at the bottom.

4.1.3 Distribution Box Status and Port Control

Manage the power status of the distribution box ports and perform intelligent control.

The screenshot displays the 'Box Status and Port Control' interface. On the left, there is a navigation menu with 'System', 'Network', and 'Maintenance' sections. The main area is titled 'Box Status and Port Control' and contains a table with the following data:

Output Port	Voltage Output Value	Voltage Status	Current Output Value	Current Status	On/Off	Intelligent Control	Operate
Socket	225.15V	Normal	0.00A	Normal	<input checked="" type="checkbox"/>		
AC220V/DC48V	225.15V	Normal	0.00A	Normal	<input checked="" type="checkbox"/>		
Heater	225.15V	Normal	0.00A	Normal	<input type="checkbox"/>	Auto Temperature: <input checked="" type="checkbox"/>	
Warning Light	1.80V	Normal	0.20A	Normal	<input checked="" type="checkbox"/>	Alarm Linkage: <input checked="" type="checkbox"/>	
Network Device	1.80V	Normal	0.33A	Normal		Auto Disconnect: <input checked="" type="checkbox"/>	<input type="button" value="Restart"/>
Fan	1.80V	Normal	0.25A	Normal	<input type="checkbox"/>	Auto Temperature: <input checked="" type="checkbox"/>	

Below the table is the 'Box Environment' section, which includes several status cards:

- Temperature: 57.94°C (Normal)
- Humidity: 13.00% (Normal)
- Box Door Status: Closed
- Fan: Off
- Heater Status: Off
- Surge Protector Status: Normal
- Input Voltage: 225.15V (Normal)
- Total Current: 0.00A (Normal)
- Leakage: No

- On/Off: Controls the enabling/disabling of the port.
- Auto Temperature Control: When enabled, the power management module automatically turns on the heater when the temperature falls below the low-temperature threshold, and activates the fan when it rises above the high-temperature threshold.
- Alarm Linkage: When enabled, the power management module receives alarm output signals from the customer device. If the warning light is on and the customer device triggers an alarm output, the warning light will flash synchronously.
- Auto Disconnect Detection: Once enabled, the box will automatically monitor its connection status with EZCloud. If it fails to ping the server 4 consecutive times, it will restart the port (up to 5 attempts). After 5 failed attempts, it will stop trying to reconnect.
- Restart: Click to restart the router.

4.1.4 Network Configuration

1 Network

Use DHCP (default mode) to automatically assign an IP address.

<ul style="list-style-type: none"> System Box Status and Po... Network <ul style="list-style-type: none"> Network EZCloud Maintenance 	<h3>Network</h3> <table border="1"> <tr> <td>Obtain IP Address</td> <td>DHCP</td> </tr> <tr> <td>IP Address</td> <td>192.168.168.134</td> </tr> <tr> <td>IPv4 Subnet Mask</td> <td>255.255.254.0</td> </tr> <tr> <td>Default Gateway</td> <td>192.168.168.1</td> </tr> <tr> <td>Preferred DNS Server</td> <td>8.8.8.8</td> </tr> <tr> <td>Alternate DNS Server</td> <td>8.8.4.4</td> </tr> </table> <p>Save</p>	Obtain IP Address	DHCP	IP Address	192.168.168.134	IPv4 Subnet Mask	255.255.254.0	Default Gateway	192.168.168.1	Preferred DNS Server	8.8.8.8	Alternate DNS Server	8.8.4.4
Obtain IP Address	DHCP												
IP Address	192.168.168.134												
IPv4 Subnet Mask	255.255.254.0												
Default Gateway	192.168.168.1												
Preferred DNS Server	8.8.8.8												
Alternate DNS Server	8.8.4.4												

2 EZCloud

After adding the power management module in the app, enable this option to automatically connect to the cloud.

<ul style="list-style-type: none"> System Box Status and Po... Network <ul style="list-style-type: none"> Network EZCloud Maintenance 	<h3>EZCloud</h3> <table border="1"> <tr> <td>EZCloud</td> <td><input checked="" type="radio"/> On <input type="radio"/> Off</td> </tr> <tr> <td>Server IP</td> <td>ezcloud.uni-view.com</td> </tr> <tr> <td>Register Code</td> <td>5LNCXBACBAGLRF7TWJHILAMYB3 <input type="button" value="Copy"/></td> </tr> <tr> <td>Device Status</td> <td>Online <input type="button" value="Logout"/></td> </tr> <tr> <td>Username</td> <td>dnqq</td> </tr> <tr> <td>Service Agreement</td> <td>http://ezcloud.uni-view.com/doc/termsofservice.html</td> </tr> </table>	EZCloud	<input checked="" type="radio"/> On <input type="radio"/> Off	Server IP	ezcloud.uni-view.com	Register Code	5LNCXBACBAGLRF7TWJHILAMYB3 <input type="button" value="Copy"/>	Device Status	Online <input type="button" value="Logout"/>	Username	dnqq	Service Agreement	http://ezcloud.uni-view.com/doc/termsofservice.html
EZCloud	<input checked="" type="radio"/> On <input type="radio"/> Off												
Server IP	ezcloud.uni-view.com												
Register Code	5LNCXBACBAGLRF7TWJHILAMYB3 <input type="button" value="Copy"/>												
Device Status	Online <input type="button" value="Logout"/>												
Username	dnqq												
Service Agreement	http://ezcloud.uni-view.com/doc/termsofservice.html												

4.1.5 System Maintenance

1 Device Status

View the basic information and operation status of the device.

<ul style="list-style-type: none"> System Box Status and Po... Network Maintenance <ul style="list-style-type: none"> Basic Info Maintenance 	<h3>Basic Info</h3> <table border="1"> <tr> <td colspan="2">Basic Info</td> </tr> <tr> <td>Model</td> <td></td> </tr> <tr> <td>Serial No.</td> <td></td> </tr> <tr> <td>Hardware Version</td> <td>ENC-0302C590</td> </tr> <tr> <td>Firmware Version</td> <td></td> </tr> <tr> <td>Boot Version</td> <td>V0.1</td> </tr> <tr> <td colspan="2">Status</td> </tr> <tr> <td>System Time</td> <td>2025/5/8 17:33:52</td> </tr> <tr> <td>Operation Time</td> <td>0 Day(s) 3 Hour(s) 23 Minute(s)</td> </tr> </table> <p>Refresh</p>	Basic Info		Model		Serial No.		Hardware Version	ENC-0302C590	Firmware Version		Boot Version	V0.1	Status		System Time	2025/5/8 17:33:52	Operation Time	0 Day(s) 3 Hour(s) 23 Minute(s)
Basic Info																			
Model																			
Serial No.																			
Hardware Version	ENC-0302C590																		
Firmware Version																			
Boot Version	V0.1																		
Status																			
System Time	2025/5/8 17:33:52																		
Operation Time	0 Day(s) 3 Hour(s) 23 Minute(s)																		

2 System maintenance



Perform maintenance operations to the device.

- Restart the device: Click **Restart**, then confirm to restart the device. The login page is displayed after the device completes restart.
- Export configurations: Click **Export** next to **Export configuration file** to export the current configuration information of the device.
- Export diagnosis information: Click **Export** next to **Export Diagnosis Info** to export the diagnosis information of the device.
- Restore defaults: Select **Restore all settings to defaults without keeping current network and user settings** (if needed) and then click **Default** to restore default settings.
- Import configurations: Click **Browse** next to the **Importing** field, locate the configuration file to import, and then click **Import** to apply the new configurations.
- Local upgrade: Click **Browse** next to the **Local Upgrade** field, locate the upgrade file, select **Upgrade Boot Program**, click **Upgrade**, and then confirm to start the upgrade. The device will restart and display the login screen after completing the restart.

CAUTION!

- Do not power off the device during upgrade.
- A progress bar will be displayed. Please wait patiently and avoid other operations. After the upgrade is complete, check to ensure that the device has been upgraded to the correct version.

5. IMSPortal Management

1. Open a browser and enter `imsportal.ezcloud.uniview.com`. Register and log in to the portal.
2. Click  to create an organization, then click  to add the box using the register code on the box.

- Restart: Supports remote restart of the router, customer device, and sockets (AC models only).
- Enable: Enable/disable each functional port on the power management module.
- Auto Temperature Control: When enabled, the power management module automatically turns on the heater when the temperature falls below the low-temperature threshold, and activates the fan when it rises above the high-temperature threshold.
- Alarm Linkage: When enabled, the power management module receives alarm output signals from the customer device. If the warning light is on and the customer device triggers an alarm output, the warning light will flash synchronously.

Power On/Off and Restart If restarting a device does not work, try restarting the entire system. ×

 Router Restart <input checked="" type="checkbox"/>	 AC220V/DC48V Restart <input checked="" type="checkbox"/> Switch <input checked="" type="checkbox"/>	 Socket Restart <input checked="" type="checkbox"/> Switch <input checked="" type="checkbox"/>	 Heater Switch <input type="checkbox"/> Auto Temp... <input type="checkbox"/>	 Fan Switch <input checked="" type="checkbox"/> Auto Temp... <input type="checkbox"/>	 Warning Light Switch <input type="checkbox"/> Alarm Lin... <input type="checkbox"/>
--	--	--	---	---	--



NOTE!

For additional system configuration needs, click to go to the login page of the corresponding device's web interface.

Total Device(s) (3) Show Sub-Orga...

<input type="checkbox"/>	Device Name	IP	Organization	Deliver To	Last Onli...	Action
<input type="checkbox"/>	-	

6. App Management

Scan the QR code below to download and install the app.



NOTE!

For detailed instructions, refer to the user manual of the app.
