

5MP WDR LightHunter IR Network Bullet Camera

IPC2225SB-ADF60KM-I1

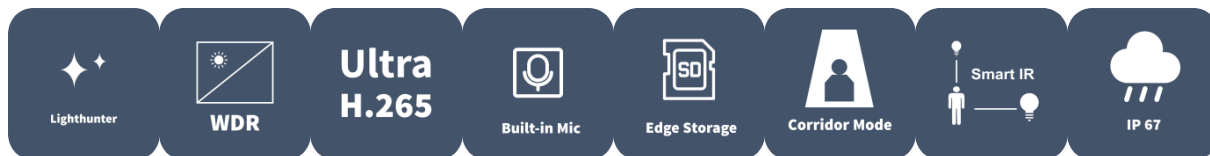

Features

- High quality image with 5MP,1/2.7 CMOS sensor
- 2880*1620@30fps in the main stream
- Ultra 265, H.265, H.264, MJPEG
- Smart intrusion prevention, support Cross Line and Intrusion based on human body and vehicle detection
- LightHunter technology ensures ultra-high image quality in low illumination environment
- Support 9:16 Corridor Mode
- Up to 120 dB Optical WDR (Wide Dynamic Range)
- Support Smart IR, up to 80m IR range
- DC12V or PoE (IEEE 802.3af) power supply
- Audio 1 in and 1 out, Alarm 1 in and 1 out
- Built-in Mic
- IP67,IK10

Specifications

Model	IPC2225SB-ADF60KM-I1
Camera	
Sensor	1/2.7" CMOS
Min. Illumination	Colour:0.003 lux (F1.6, AGC ON) 0 lux with IR
Day/Night	IR-cut filter with auto switch (ICR)
Shutter	Auto/Manual,1 to 1/100000 s
WDR	120 dB
S/N	>56 dB
Lens	
Focal Length	6.0 mm
Iris	F1.6
Field of View (H)	56.3°
Field of View (V)	29.9°
Field of View (D)	69.2°
Iris Type	Fixed
DORI	
DORI Distance (Lens)	6.0mm
DORI Distance (Detect)	135.0m(442.9ft)
DORI Distance (Observe)	54.0m(177.2ft)
DORI Distance (Recognize)	27.0m(88.6ft)
DORI Distance (Identify)	13.5m(44.3ft)
Illuminator	
Illumination Distance (IR)	80 m (262 ft)
IR On/Off Control	Auto/Manual
Wavelength	850 nm
Video	
Privacy Mask	Up to 4 areas per scene
Frame Rate-Main Stream	5MP (2880*1620), Max 30fps

Frame Rate-Sub Stream	720P (1280*720), Max 30fps
Video Compression	Ultra 265, H.265, H.264, MJPEG
Video Bit Rate	128 Kbps to 16 Mbps
ROI	Support
Video Stream	Dual Streams
OSD	Up to 4 OSDs
Image	
Defog	Digital Defog
White Balance	Auto, Outdoor, Fine Tune, Sodium Lamp, Locked, Auto2
Digital Noise Reduction	2D/3D DNR
Smart IR	Support
Flip	Normal, Flip Vertical, Flip Horizontal, 180°, 90°Clockwise, 90°Anti-clockwise
HLC	Support
BLC	Support
Heatwave Reduction	N/A
Intelligent	
Smart Intrusion Prevention	Cross line detection, intrusion detection (support false alarm filtering and the classification of human and vehicle)
Events	
Basic Detection	Motion Detection, Ultra Motion Detection (based on Human Body and Vehicle Detection), Tampering Alarm, Audio Detection
General Function	Watermark, IP Address Filtering, Access Policy, ARP Protection, RTSP Authentication, User Authentication, HTTP authentication, Alarm input, Alarm output
Audio	
Audio Compression	G.711U, G.711A
Audio Bitrate	128 Kbps
Two-way Audio	Support
Suppression	Support
Sampling Rate	16KHZ
Storage	
Edge Storage	Micro SD, up to 512 GB
Network Storage	ANR, NAS (NFS)

Network	
Protocols	SSH, IGMP, RTP, RTCP, SMTP, IPv4, IPv6, ICMP, ARP, TCP, UDP, DHCP, PPPoE, RTSP, RTMP, DNS, DDNS, NTP, FTP, UPnP, HTTP, HTTPS, 802.1x, SNMP, QoS, SSL/TLS
Compatible Integration	ONVIF (Profile S, Profile G, Profile T, Profile M), SDK, API
User/Host	Up to 32 users. 3 user levels: administrator, common user and operator
Security	TLS1.3, Password Protection, Strong Password, HTTPS Encryption, Export Operation Logs, Basic and Digest Authentication for RTSP, Digest Authentication for HTTP, TLS 1.2, WSSE and Digest Authentication for ONVIF
Client	EZStation, UNV-Link, UNV-Link Pro
Web Browser	Plug-in required live view: IE 10+, Chrome 45+, Firefox 52+, Edge 79+, Plug-in free live view: Chrome 57+, Firefox 58+, Edge 16+
Interface	
Audio I/O	1 Input: impedance 1 k Ω , amplitude 2.5 V [p-p], 1 Output: impedance 600 Ω , amplitude 2.5 V [p-p]
Alarm I/O	1/1
Built-in Mic	Support
Network	1 \times RJ45 10 M/100 M Base-TX Ethernet
Certification	
EMC	CE-EMC (EN 55032: 2015+A1:2020, EN 61000-3-3: 2013+A1: 2019, EN IEC 61000-3-2: 2019+A1: 2021, EN 55035: 2017+A11:2020) FCC (FCC CFR 47 part15 B, ANSI C63.4-2014)
Safety	CE LVD (EN 62368-1:2014+A11:2017) UL (UL 62368-1, 2nd Ed., Issue Date: 2014-12-01)
Environment	CE-RoHS (2011/65/EU;(EU)2015/863); WEEE (2012/19/EU); Reach (Regulation (EC) No 1907/2006)
Protection	IP67 (IEC 60529:1989+AMD1:1999+AMD2:2013) IK10 (IEC 62262:2002)
General	
Power	DC12V(\pm 25%) , PoE (IEEE 802.3af)
Power Consumption	Max 8W
Power Interface	\varnothing 5.5 mm coaxial power plug
Dimensions	245 x 87 x 86mm (9.6" x 3.4" x 3.4") (L x W x H)
Weight	0.82kg(1.81lb)

Working Environment	-30°C ~ 60°C (-22°F ~ 140°F), Humidity: 5%~95% RH (non-condensing)
Storage Environment	-40°C ~ 70°C (-40°F ~ 158°F), Humidity: 5%~95% RH (non-condensing)
Web Client Language	22 Languages Traditional Chinese, English, Simplified Chinese, Polish, German, Russian, French, Korean, Dutch, Czech, Portuguese (Europe), Portuguese (Brazil), Japanese, Thai, Turkish, Spanish (Latin America), Spanish (Europe), Hungarian, Italian, Vietnamese, Arabic, Slovak

Dimensions

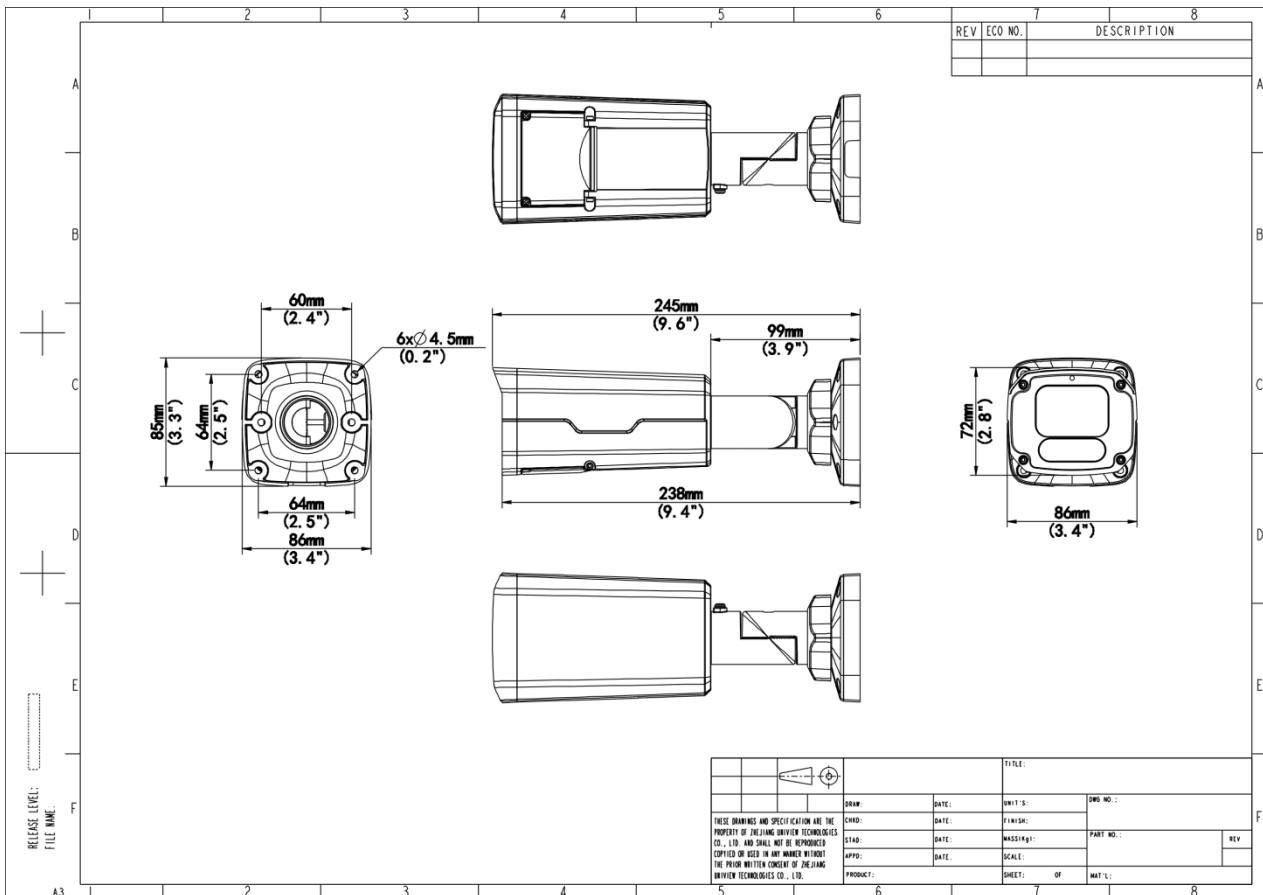

Accessories

TR-JB07-D-IN

Bullet Junction Box(Support wiring from m behind)



TR-JB06-A-IN

Middle Bullet Junction Box(Elegant White)



TR-UP06-B-IN

Bullet Pole Mounting Bracket



TR-UP06-C-IN

Pole Mounting Bracket for Bullet Junction Box Only



TR-A01-IN

NPT 3/4" Waterproof Cable Gland



Zhejiang Uniview Technologies Co., Ltd.

No. 369, Xietong Road, Xixing Sub-district, Binjiang District, Hangzhou City, 310051, Zhejiang Province, China (Zhejiang) Pilot Free Trade Zone, China

Email: overseasbusiness@uniview.com; globalsupport@uniview.com

<http://www.uniview.com>

©2023-2024 Zhejiang Uniview Technologies Co., Ltd. All rights reserved.

*Product specifications and availability are subject to change without notice.

*Despite our best efforts, technical or typographical errors may exist in this document. Uniview cannot be held responsible for any such errors and reserves the right to change the contents of this document without prior notice.