

# 4MP HD Intelligent LightHunter IR VF Dome Network Camera IPC3234SB-ADZK-I0

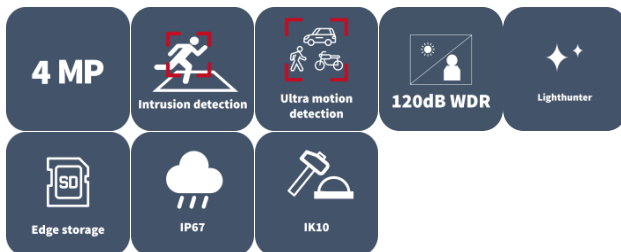

## Features

- High quality image with 4 MP, 1/3.0" CMOS sensor
- 4 MP (2688 × 1520)@30/25 fps; 4 MP (2560 × 1440)@30/25 fps; 3 MP (2304 × 1296)@30/25 fps; 1080P (1920 × 1080)@30/25 fps
- Ultra 265, H.265, H.264, MJPEG
- Intelligent perimeter protection, including cross line, intrusion, enter area, leave area detection
- Intelligent intrusion prevention system based on target classification significantly reduces false alarms caused by leaves, birds, and lights, accurately focusing on humans, vehicles, and non-motor vehicles
- Intelligent people flow counting and crowd density monitoring
- LightHunter technology ensures ultra-high image quality in low illumination environment
- 120 dB true WDR technology enables clear image in strong light scene
- Supports 9:16 corridor mode
- Built-in mic
- Alarm I/O: 1/1, audio I/O: 1/1
- Smart IR, up to 40 m (131.2 ft) IR distance
- MicroSD, up to 512 GB
- IK10 vandal resistant and IP67 protection

## Specifications

| Model                      | IPC3234SB-ADZK-I0  |
|----------------------------|--|
| <b>Camera</b>              |  |
| Max Resolution             | 4 MP   |
| Sensor                     | 1/3.0" CMOS  |
| Min. Illumination          | Color: 0.002 Lux (F1.2, AGC ON), 0 Lux with IR   |
| Day/Night                  | IR-cut filter with auto switch (ICR)   |
| Shutter                    | Auto/Manual, 1 ~ 1/100000s   |
| Adjustment Angle           | Pan: 0° to 355°, Tilt: 0° to 80°, Rotate: 0° to 355°   |
| S/N                        | >52 dB   |
| WDR                        | 120 dB   |
| <b>Lens</b>                |  |
| Focal Length               | 2.7 to 13.5 mm   |
| Iris Type                  | Fixed  |
| Iris                       | F1.2   |
| Field of View (H)          | 98.26° to 31.35°   |
| Field of View (V)          | 54.76° to 18.55°   |
| Field of View (D)          | 127.74° to 36.99°  |
| Lens Type                  | Motorized  |
| <b>DORI</b>                |  |
| DORI Distance (Lens)       | 2.7 to 13.5 mm   |
| DORI Distance (Detect)     | 60.8 m to 303.8 m (199.5 ft. to 996.7 ft.)   |
| DORI Distance (Observe)    | 24.3 m to 121.5 m (79.7 ft. to 398.6 ft.)  |
| DORI Distance (Recognize)  | 12.2 m to 60.8 m (40.0 ft. to 199.5 ft.)   |
| DORI Distance (Identify)   | 6.1 m to 30.4 m (20.0 ft. to 99.7 ft.)   |
| <b>Illuminator</b>         |  |
| Supplemental Light         | IR   |
| Illumination Distance (IR) | 40 m (131.2 ft.)   |
| Wavelength                 | 850 nm   |
| Light On/Off Control       | Auto/Manual  |
| <b>Video</b>               |  |
| Video Compression          | Ultra 265, H.265, H.264, MJPEG   |
| H.264 Code Profile         | Baseline profile, Main profile, High profile   |
| Frame Rate                 | Main Stream: 4 MP (2688 × 1520), max. 30 fps; 4 MP (2560 × 1440), max. 30 fps; 3 MP (2304 × 1296), max. 30 fps; 1080P (1920 × 1080), max. 30 fps;<br>Sub Stream: 720P (1280 × 720), max. 30 fps; D1 (720 × 576), max. 30 fps; 640 × 360, max. 30 fps;<br>Third Stream: D1 (720 × 576), max. 30 fps; 640 × 360, max. 30 fps; 2CIF (704 × 288), max. 30 fps; CIF (352 × 288), max. 30 fps; |
| Video Bit Rate             | 128 Kbps to 16 Mbps  |
| U-code                     | Support  |
| OSD                        | Up to 8 OSDs   |
| Privacy Mask               | Up to 4 areas  |





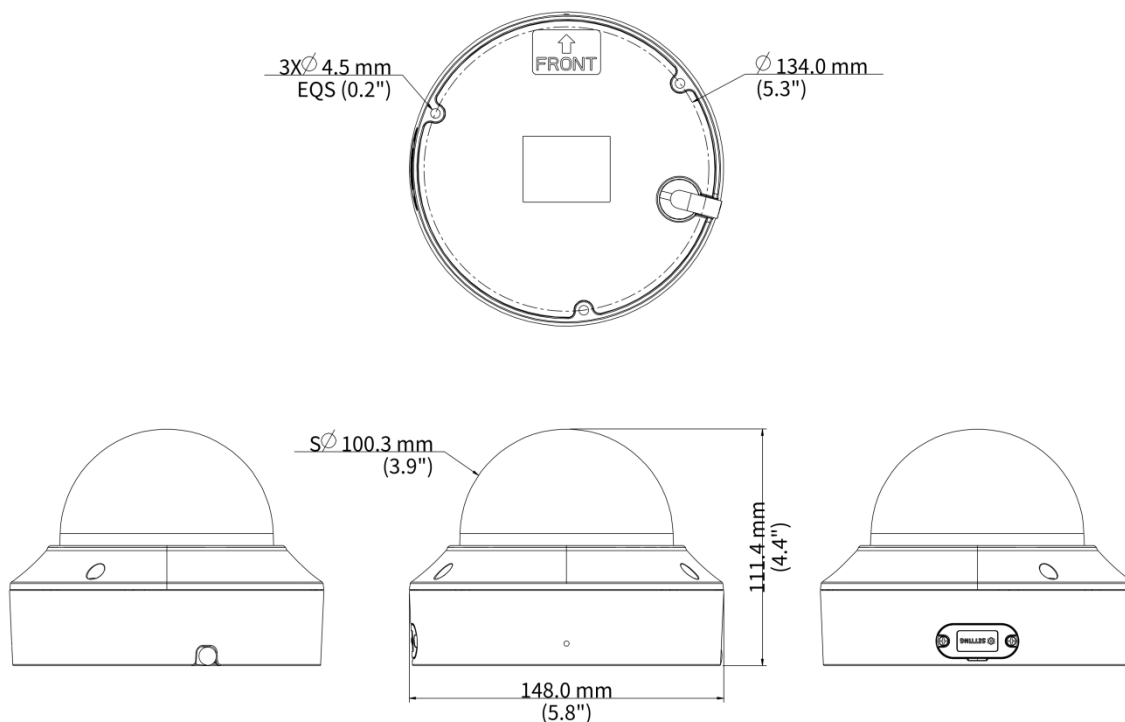

|                            |  |
|----------------------------|--|
| ROI                        | Support  |
| Video Stream               | Triple streams   |
| Image                      |  |
| Smart IR                   | Support  |
| White Balance              | Auto, Outdoor, Fine tune, Sodium lamp, Locked, Auto2   |
| Digital Noise Reduction    | 2D/3D DNR  |
| Flip                       | Normal, Flip vertical, Flip horizontal, 180°, 90° Clockwise, 90° Anti-clockwise  |
| Dewarping                  | N/A  |
| HLC                        | Support  |
| BLC                        | Support  |
| Defog                      | Digital defog  |
| Intelligent                |  |
| Smart Intrusion Prevention | Cross line detection, intrusion detection, enter area detection, leave area detection (support false alarm filtering and the classification of human, non-motor vehicle and vehicle)                       |
| People Counting            | Support people flow counting and crowd density detection   |
| Statistical Analysis       | N/A  |
| Events                     |  |
| Basic Detection            | Motion detection, Ultra motion detection, Tampering alarm, Audio detection   |
| General Function           | Watermark, IP address filtering, Access policy, ARP protection, RTSP authentication, User authentication, HTTP authentication  |
| Audio                      |  |
| Audio Compression          | G.711U, G.711A, AAC-LC   |
| Audio Bitrate              | G.711U/G.711A: 64 kbps, AAC-LC: 128 kbps   |
| Two-way Audio              | Support  |
| Suppression                | Support  |
| Sampling Rate              | G.711U/G.711A: 8 kHz, AAC-LC: 8 kHz, 16 kHz, 48 kHz  |
| Storage                    |  |
| Edge Storage               | MicroSD, up to 512 GB  |
| Network Storage            | ANR, NAS (NFS)   |
| Network                    |  |
| Protocols                  | IPv4, IPv6, IGMP, ICMP, ARP, TCP, UDP, DHCP, RTP, RTSP, RTCP, RTMP, DNS, DDNS, NTP, FTP, UPnP, HTTP, HTTPS, SMTP, SSL/TLS, 802.1x, SNMP, PPPoE   |
| Compatible Integration     | ONVIF (Profile S, Profile G, Profile T, Profile M), API, SDK   |
| User/Host                  | Up to 32 users. 3 user levels: administrator, common user and operator   |
| Security                   | Password Protection, Strong Password, HTTPS Encryption, Export Operation Logs, Basic and Digest Authentication for RTSP, Digest Authentication for HTTP, TLS 1.2, WSSE and Digest Authentication for ONVIF |
| Client                     | EZStation, APP   |
| Web Browser                | Plug-in required live view: IE 10+, Chrome 45+, Firefox 52+, Edge 79+, Plug-in free live view: Chrome 57+, Firefox 58+, Edge 16+   |
| Interface                  |  |
| Audio I/O                  | 1 Input: impedance 35 k $\Omega$ , amplitude 2 V [p-p], 1 Output: impedance 600 $\Omega$ , amplitude 2 V [p-p]   |
| Alarm I/O                  | 1/1  |



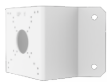

|                      |   |
|----------------------|---|
| Serial Port          | N/A   |
| Built-in Mic         | Support   |
| Built-in Speaker     | N/A   |
| WIFI                 | N/A   |
| Network              | 1 × RJ45 10 M/100 M Base-TX Ethernet  |
| Video Output         | N/A   |
| <b>Certification</b> |   |
| EMC                  | CE-EMC (EN 55032, EN 61000-3-3, EN IEC 61000-3-2, EN 55035)<br>FCC (FCC 47 CFR part15 B)  |
| Safety               | CE LVD (EN 62368-1)<br>CB (IEC 62368-1)<br>UL/CUL (UL 62368-1, CAN/CSA C22.2 No. 62368-1)   |
| Environment          | CE-RoHS (2011/65/EU;(EU)2015/863); WEEE (2012/19/EU);   |
| Protection           | IP67 (IEC 60529)<br>IK10 (IEC 62262)  |
| <b>General</b>       |   |
| Power                | DC 12 V±25%, PoE (IEEE 802.3af)   |
| Power Consumption    | Max. 7.0 W  |
| Power Interface      | Ø5.5 mm coaxial power plug  |
| Dimensions           | Ø148 mm × 111.3 mm (Ø5.8" × 4.4") (Ø × H)   |
| Weight               | 0.92 kg (2.03 lb.)  |
| Material             | Metal   |
| Working Environment  | -30 °C to 60 °C (-22 °F to 140 °F), Humidity: ≤ 95% RH (non-condensing)   |
| Storage Environment  | -30 °C to 60 °C (-22 °F to 140 °F), Humidity: ≤ 95% RH (non-condensing)   |
| Surge Protection     | 6 KV  |
| Reset Button         | Support   |
| Web Client Language  | 20 Languages: Traditional Chinese, English, Simplified Chinese, Polish, German, Russian, French, Korean, Dutch, Czech, Portuguese (Europe), Portuguese (Brazil), Japanese, Thai, Turkish, Spanish (Latin America), Spanish (Europe), Hungarian, Italian, Vietnamese |

# Dimensions



# Accessories

|   |   |   |
|---|---|---|
| <p><b>TR-JB04-C-IN</b><br/>Junction Box for 323 Series<br/>Fix-dome(Support wiring from behind)</p> | <p><b>TR-FM152-A-IN</b><br/>In-ceiling Bracket for 323 Series<br/>Fix-dome</p>      | <p><b>TR-SM04-IN</b><br/>Switch Box Adapter for 323 Series<br/>Fix-dome</p>                         |
|                  |  |                |
| <p><b>TR-A01-IN</b><br/>NPT 3/4" Waterproof Cable Gland</p>   | <p><b>TR-UC08-C-V2</b><br/>Bullet&amp;Dome Corner Mounting Bracket</p>              | <p><b>TR-JB07/WM04-B-IN-V2</b><br/>4 Inch Back Hole Hemisphere Wall Mounting Assembling Bracket</p> |
|                  |  |                |

|   |  |   |
|---|--|---|
| <p><b>TR-WM04-IN-V2</b><br/>4 Inch Hemisphere Wall Mounting Bracket</p>           | <p><b>TR-CM24-IN</b><br/>Dome Pendant Mounting Bracket(Indoor)</p>                       | <p><b>TR-SE24-A-IN</b><br/>Dome Pendant Mounting Pole 500mm</p>                     |
|  |         |  |
| <p><b>TR-SE24-IN</b><br/>Dome Pendant Mounting Pole 200mm</p>                     | <p><b>TR-UP06-C-IN-V2</b><br/>Pole Mounting Bracket for Bullet Junction<br/>Box Only</p> |   |
|  |         |   |

# Unlimited New View

## Zhejiang Uniview Technologies Co., Ltd.



<http://www.uniview.com>



[overseasbusiness@uniview.com](mailto:overseasbusiness@uniview.com); [globalsupport@uniview.com](mailto:globalsupport@uniview.com)



No. 369, Xietong Road, Xixing Sub-district, Binjiang District, Hangzhou City, 310051, Zhejiang Province, China



©2023-2025 Zhejiang Uniview Technologies Co., Ltd. All rights reserved.

\*Product specifications and availability are subject to change without notice.

Despite our best efforts, technical or typographical errors may exist in this document. Uniview cannot be held responsible for any such errors and reserves the right to change the contents of this document without prior notice.