

4MP HD Vandal-resistant IR Fixed Dome Network Camera IPC324SR3-DSF40KM-G



Features

- High quality image with 4 MP, 1/3.0" CMOS sensor
- 4 MP (2688 × 1520)@25/20 fps; 4 MP (2560 × 1440)@25/20 fps; 3 MP (2304 × 1296)@30/25 fps; 1080P (1920 × 1080)@30/25 fps
- Ultra 265, H.265, H.264, MJPEG
- EasyStar technology ensures high image quality in low illumination environment
- 120 dB true WDR technology enables clear image in strong light scene
- Supports 9:16 corridor mode
- Smart IR, up to 30 m (98.4 ft.) IR distance
- MicroSD, up to 256 GB
- IK10 vandal resistant
- IP67 protection
- Supports PoE power supply
- 3-axis

Specifications

Model	IPC324SR3-DSF40KM-G
Camera	
Max Resolution	4 MP
Sensor	1/3.0" CMOS
Min. Illumination	Support Easystar: color: 0.003 Lux (F1.6, AGC ON), 0 Lux with IR
Day/Night	IR-cut filter with auto switch (ICR)
Shutter	Auto/Manual, 1 ~ 1/100000s
Adjustment Angle	Pan: 3° to 360°, Tilt: 0° to 68°, Rotate: 3° to 360°
S/N	>52 dB
WDR	120 dB
Lens	
Focal Length	4.0 mm
Iris	F1.6
Field of View (H)	83.7°
Field of View (V)	44.9°
Field of View (D)	89.2°
Lens Type	Fixed
DORI	
DORI Distance (Lens)	4 mm
DORI Distance (Detect)	90.0 m (295.3 ft.)
DORI Distance (Observe)	36.0 m (118.1 ft.)
DORI Distance (Recognize)	18.0 m (59.1 ft.)
DORI Distance (Identify)	9.0 m (29.5 ft.)
Illuminator	
Illumination Distance (IR)	30 m (98.4 ft.)
Wavelength	850 nm
IR On/Off Control	Auto/Manual
Video	
Video Compression	Ultra 265, H.265, H.264, MJPEG
H.264 Code Profile	Baseline profile, Main profile, High profile
Frame Rate	Main Stream: 4 MP (2688 × 1520), max. 25 fps; 4 MP (2560 × 1440), max. 25 fps; 3 MP (2304 × 1296), max. 30 fps; 1080P (1920 × 1080), max. 30 fps; Sub Stream: 720P (1280 × 720), max. 30 fps; D1 (720 × 576), max. 30 fps; 640 × 360, max. 30 fps;
Video Bit Rate	128 Kbps to 16 Mbps
U-code	Support
OSD	Up to 4 OSDs
Privacy Mask	Up to 4 areas
ROI	Up to 8 areas
Video Stream	Dual streams
Image	
White Balance	Auto, Outdoor, Fine tune, Sodium lamp, Locked, Auto2







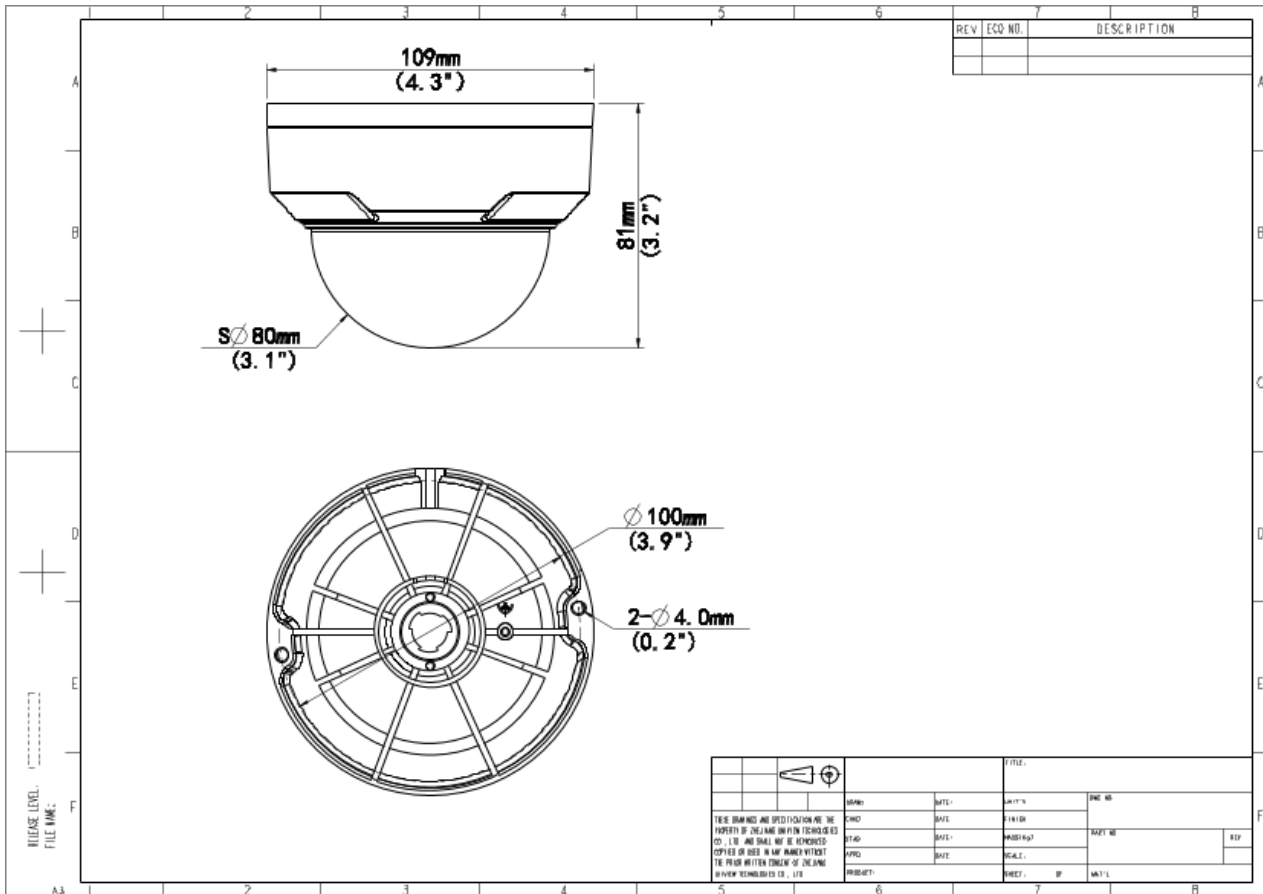



Digital Noise Reduction	2D/3D DNR
Smart IR	Support
Flip	Normal, Flip vertical, Flip horizontal, 180°, 90° Clockwise, 90° Anti-clockwise
Dewarping	N/A
HLC	Support
BLC	Support
Defog	Digital defog
Events	
Basic Detection	Motion detection, Tampering alarm, Cross line (based on human body detection), Intrusion (based on human body detection), Ultra motion detection
General Function	Watermark, IP address filtering, Access policy, ARP protection, RTSP authentication, User authentication, HTTP authentication
Storage	
Edge Storage	MicroSD, up to 512 GB
Network Storage	ANR, NAS (NFS)
Network	
Protocols	IPv4, IPv6, IGMP, ICMP, ARP, TCP, UDP, DHCP, RTP, RTSP, RTCP, RTMP, DNS, DDNS, NTP, FTP, UPnP, HTTP, HTTPS, SMTP, SSL/TLS, 802.1x, SNMP, PPPoE
Compatible Integration	ONVIF (Profile S, Profile G, Profile T), API, SDK
User/Host	Up to 32 users. 3 user levels: administrator, common user and operator
Security	Password Protection, Strong Password, HTTPS Encryption, Export Operation Logs, Basic and Digest Authentication for RTSP, Digest Authentication for HTTP, TLS 1.2, WSSE and Digest Authentication for ONVIF
Client	UNV-Link, UNV-Link Pro, EZStation
Web Browser	Plug-in required live view: IE 10+, Chrome 45+, Firefox 52+, Edge 79+, Plug-in free live view: Chrome 57+, Firefox 58+, Edge 16+
Interface	
Audio I/O	N/A
Alarm I/O	N/A
Serial Port	N/A
Built-in Mic	N/A
Built-in Speaker	N/A
WIFI	N/A
Network	1 × RJ45 10 M/100 M Base-TX Ethernet
Video Output	N/A
Certification	
EMC	CE-EMC (EN 55032, EN 61000-3-3, EN IEC 61000-3-2, EN 55035) FCC (FCC 47 CFR part15 B)
Safety	CE LVD (EN 62368-1) CB (IEC 62368-1) UL/CUL (UL 62368-1, CAN/CSA C22.2 No. 62368-1)
Environment	CE-RoHS (2011/65/EU;(EU)2015/863); WEEE (2012/19/EU);
Protection	IP67 (IEC 60529)

	IK10 (IEC 62262)
General	
Power	DC 12 V±25%, PoE (IEEE 802.3af) Power consumption: Max. 5.5 W
Power Interface	Ø5.5 mm coaxial power plug
Dimensions	Ø109 mm × 81 mm (Ø4.3" × 3.2") (Ø × H)
Weight	0.35 kg (0.77 lb.)
Material	Metal
Working Environment	-30 °C to 60 °C (-22 °F to 140 °F), Humidity: ≤ 95% RH (non-condensing)
Storage Environment	-30 °C to 60 °C (-22 °F to 140 °F), Humidity: ≤ 95% RH (non-condensing)
Surge Protection	4 KV
Reset Button	N/A
Web Client Language	13 Languages: English, Simplified Chinese, Polish, German, Russian, French, Korean, Dutch, Czech, Portuguese, Spanish, Spanish (Europe), Italian

Dimensions

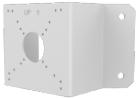

Accessories

<p>TR-JB03-G-IN Junction Box for Mini Fix-dome(Support wiring from behind)</p>	<p>TR-JB07/WM03-G-IN Wall Mounting Assembling Bracket For 32 Fix-dome&Mini Fix-dome&Plastic Turret Camera</p>	<p>TR-WM03-D-IN Wall Mounting Bracket for 32 Fix-dome&Mini Fix-dome&Plastic Turret Camera</p>
		
<p>TR-UM06-E-IN Slant Mounting Bracket for Fixed Dome</p>	<p>TR-A01-IN NPT 3/4" Waterproof Cable Gland</p>	<p>TR-UP06-IN Universal Pole Mounting Bracket</p>
		
<p>TR-UC08-C Bullet&Dome Corner Mounting Bracket</p>	<p>TR-SE24-IN Dome Pendent Mounting Pole 200mm</p>	<p>TR-SE24-A-IN Dome Pendent Mounting Pole 500mm</p>
		
<p>TR-CM24-IN Dome Pendent Mounting Bracket(Indoor)</p>		
		

Unlimited New View

Zhejiang Uniview Technologies Co., Ltd.



<http://www.uniview.com>



overseasbusiness@uniview.com; globalsupport@uniview.com



No. 369, Xietong Road, Xixing Sub-district, Binjiang District, Hangzhou City, 310051, Zhejiang Province, China



©2023-2025 Zhejiang Uniview Technologies Co., Ltd. All rights reserved.

*Product specifications and availability are subject to change without notice.

Despite our best efforts, technical or typographical errors may exist in this document. Uniview cannot be held responsible for any such errors and reserves the right to change the contents of this document without prior notice.