

8MP LightHunter WDR Network Dome Camera IPC3238EA



Features

- High quality image with 8 MP, 1/1.8" CMOS sensor
- 3840 × 2160@60 fps in the main stream, offering smoother live video and more details
- Ultra 265, H.265, H.264, MJPEG
- Wise-ISP technology, comprehensive improvement in image quality
- Metadata analysis, supports human body, motor vehicle and non-motor vehicle image capture and attribute collection, realizes data visualization management, allows users to get target information for further data analysis
- supports front-end comparison, supports blacklist and allowlist comparison, increases the concurrent detection number up to 120
- Smart intrusion prevention, supports false alarm filtering, including cross line, intrusion, enter area, leave area detection
- People counting, supports people flow counting and crowd density monitoring, suitable for different statistical scenarios
- LightHunter technology ensures ultra high image quality in low illumination environment
- Up to 140 dB optical WDR (wide dynamic range)
- DC 12 V, PoE (IEEE 802.3at) power supply
- Wide voltage range of $\pm 25\%$ in DC

Specifications

Model	IPC3238EA-AHDZK-I1	IPC3238EA-AHDX4K-I1
Camera		
Sensor	1/1.8" CMOS	
Min. Illumination	Color: 0.001 Lux (F1.2, AGC ON), BW: 0.0005 Lux (F1.2, AGC ON), 0 Lux with IR	Color: 0.003 Lux (F1.6, AGC ON), BW: 0.002 Lux (F1.6, AGC ON), 0 Lux with IR
Day/Night	IR-cut filter with auto switch (ICR)	
Shutter	Auto/Manual, 1 to 1/100000 s	
WDR	140 dB	
S/N	>56 dB	
Lens		
Focal Length	2.8 to 12 mm	8 to 32 mm
Optical Zoom	4X	
Iris	F1.2	F1.6
Field of View (H)	102.5° to 48.5°	42° to 15.3°
Field of View (V)	55.1° to 27.2°	22.6° to 8.8°
Field of View (D)	126.08° to 59.66°	51.66° to 18.05°
Iris Type	P-iris	
DORI		
DORI Distance (Detect)	108.0 m to 180.0 m (354.3 ft. to 590.6 ft.)	240.3 m to 644.4 m (788.4 ft. to 2114.2 ft.)
DORI Distance (Observe)	43.2 m to 72.0 m (141.7 ft. to 236.2 ft.)	96.1 m to 257.8 m (315.4 ft. to 845.7 ft.)
DORI Distance (Recognize)	21.6 m to 36.0 m (70.9 ft. to 118.1 ft.)	48.1 m to 128.9 m (157.7 ft. to 422.8 ft.)
DORI Distance (Identify)	10.8 m to 18.0 m (35.4 ft. to 59.1 ft.)	24.0 m to 64.4 m (78.7 ft. to 211.4 ft.)
Video		
Video Compression	Ultra 265, H.265, H.264, MJPEG	
Video Bit Rate	128 Kbps to 16 Mbps	
ROI	Support	
Video Stream	Triple streams	
Privacy Mask	Up to 8 areas (8 blacks / 8 mosaics)	
OSD	Up to 10 OSDs	
Frame Rate-Main Stream	8 MP (3840 × 2160), max. 60 fps	
Frame Rate-Sub Stream	1080P (1920 × 1080), max. 60 fps	
Frame Rate-Third Stream	D1 (720 × 576), max. 60 fps	
Intelligent		
Recognition	Face recognition: Max support 16 face libraries; Max supports 100000 faces in face library	
Metadata Analyse	Support human body, human face, motor vehicle and non-motor vehicle image capture and attribute collection	
Exception Detection	Object removed Object Left Behind Scene change Defocus detection	Object removed Object Left Behind
Metadata of Multi-target Detection	Gender (face), Age range (face), Glasses (face), Gender (pedestrian), Mask (pedestrian), Upper garment color (pedestrian), Lower garment color (pedestrian), Upper garment style (pedestrian), Lower garment style (pedestrian), Bag style (pedestrian), Upper garment color	





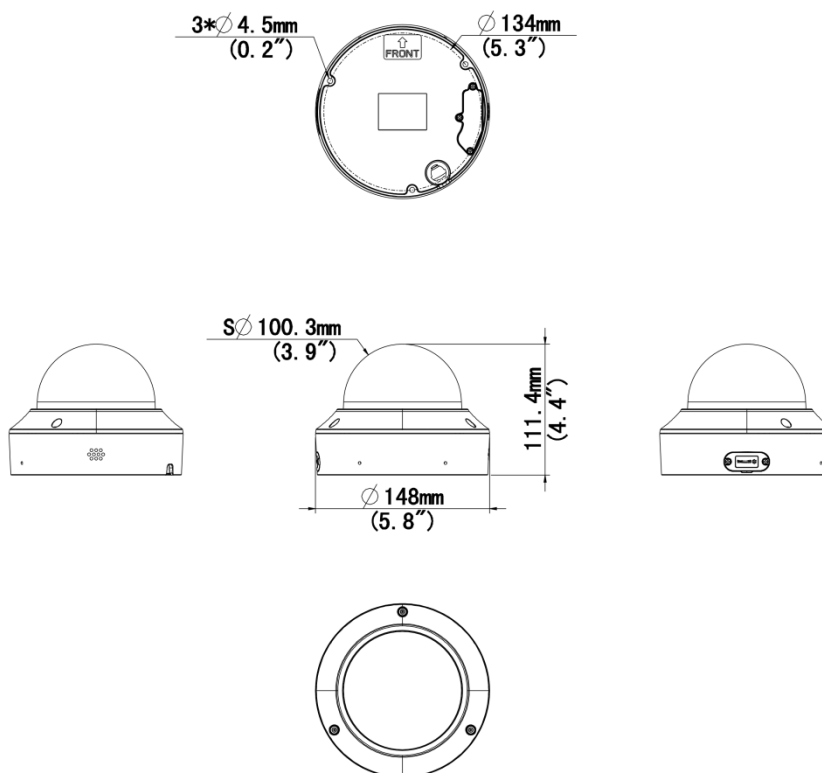

	(non-motor vehicle), Upper garment style (non-motor vehicle), Vehicle type (non-motor vehicle), Vehicle type (motor vehicle), Vehicle color (motor vehicle), Vehicle brand (motor vehicle), Plate number (motor vehicle)
Smart Intrusion Prevention	Cross line detection, intrusion detection, enter area detection, leave area detection (support false alarm filtering and the classification of human, non-motor vehicle and vehicle)
People Counting	Support people flow counting and crowd density detection
Multi-target Detection	Support human body, human face, motor vehicle and non-motor vehicle image capture and attribute collection
Image	
White Balance	Auto&Outdoor&Fine Tune&Sodium Lamp&Locked&Auto2
Digital Noise Reduction	2D/3D DNR
Flip	Normal&Flip Vertical&Flip Horizontal&180°&90°Clockwise&90°Anti-clockwise
HLC	Support
Smart IR	Support
Defog	Digital defog
Events	
Basic Detection	Motion detection Tampering alarm Audio detection Object removed Object Left Behind Scene change Defocus detection
General Function	Watermark&IP Address Filtering&Access Policy&ARP Protection&RTSP Authentication&User Authentication&HTTP authentication&Alarm input&Alarm output
Audio	
Audio Compression	G.711U&G.711A
Audio Bitrate	128 Kbps
Two-way Audio	Support
Suppression	Support
Sampling Rate	8 kHz, 16 kHz
Storage	
Edge Storage	MicroSD, up to 512 GB
Network Storage	ANR&NAS(NFS)
Network	
Protocols	IGMP, RTP, SMTP, IPv4, IPv6, ICMP, ARP, TCP, UDP, DHCP, PPPoE, RTSP, RTCP, RTMP, DNS, DDNS, NTP, FTP, UPnP, HTTP, HTTPS, 802.1x, SNMP, QoS, SSL/TLS, SSH, TLS1.3
Compatible Integration	ONVIF (Profile S, Profile G, Profile T, Profile M), API, SDK
User/Host	Up to 32 users. 3 user levels: administrator, common user and operator
Security	Password Protection, Strong Password, HTTPS Encryption, Export Operation Logs, Basic and Digest Authentication for RTSP, Digest Authentication for HTTP, TLS 1.2, WSSE and Digest Authentication for ONVIF, TLS 1.3
Client	EZStation, UNV-Link, UNV-Link Pro
Web Browser	Plug-in required live view: IE 10 and above, Chrome 45 and above, Firefox 52 and above, Edge 79 and above&Plug-in free live view: Chrome 57.0 and above, Firefox 58.0 and above, Edge 16 and above
Illuminator	

Illumination Distance (IR)	40 m (131.2 ft.)	
IR On/Off Control	Auto/Manual	
Wavelength	850 nm	
Interface		
Audio I/O	2 Input: impedance 1 k Ω , amplitude 2.5 V [p-p], 1 Output: impedance 600 Ω , amplitude 2.5 V [p-p]	
Alarm I/O	3/2	
Serial Port	1 \times RS485	
Built-in Mic	Support, built-in mic*2	
Built-in Speaker	Support	
Network	1 \times RJ45 10 M/100 M/1000 M Base-TX Ethernet	
Certification		
EMC	CE EMC (EN 55032: 2015+A1:2020,EN 61000 3 3: 2013+A1: 2019,EN IEC 61000 3 2: 2019+A1: 2021,EN 55035: 2017+A11:2020) FCC (FCC CFR 47 part15 B, ANSI C63.4 2014)	
Safety	CE LVD (EN 62368 1:2014+A11:2017) UL (UL 62368 1, 2nd Ed., Issue Date: 2014 12 01)	
Environment	CE RoHS (2011/65/EU;(EU)2015/863); WEEE (2012/19/EU); Reach (Regulation (EC) No 1907/2006)	
Protection	IP67 (IEC 60529:1989+AMD1:1999+AMD2:2013) IK10 (IEC 62262:2002)	
General		
Power	DC 12 V (\pm 25%), PoE+ (IEEE 802.3at)	
Power Consumption	Max. 19 W	
Power Interface	\varnothing 5.5 mm coaxial power plug	
Built-in DC12V Output	Support	
Dimensions	\varnothing 148 mm \times 111.4 mm (\varnothing 5.8" \times 4.4") ($\varnothing \times$ H)	
Weight	1.04 kg (2.29 lb.)	1.07 kg (2.36 lb.)
Working Environment	-40°C ~60°C (-40°F~ 140°F)	
Surge Protection	6 KV	
Heater	Support	
Configurable		
P/N	Support	

Dimensions



Accessories

<p>TR-JB04-C-IN Junction Box for 323 Series Fix-dome(Support wiring from behind)</p>	<p>TR-JB07/WM04-B-IN 4 Inch Back Hole Hemisphere Wall Mounting Assembling Bracket</p>	<p>TR-WM04-IN 4 Inch Hemisphere Wall Mounting Bracket</p>
		
<p>TR-FM152-A-IN In-ceiling Bracket for 323 Series Fix-dome</p>	<p>TR-SM04-IN Switch Box Adapter for 323 Series Fix-dome</p>	<p>TR-A01-IN NPT 3/4" Waterproof Cable Gland</p>
		

TR-UP06-IN Universal Pole Mounting Bracket	TR-UC08-C Bullet&Dome Corner Mounting Bracket	
		

Unlimited New View

Zhejiang Uniview Technologies Co., Ltd.



<http://www.uniview.com>



overseasbusiness@uniview.com; globalsupport@uniview.com



No. 369, Xietong Road, Xixing Sub-district, Binjiang District, Hangzhou City, 310051, Zhejiang Province, China



©2023-2025 Zhejiang Uniview Technologies Co., Ltd. All rights reserved.

*Product specifications and availability are subject to change without notice.

Despite our best efforts, technical or typographical errors may exist in this document. Uniview cannot be held responsible for any such errors and reserves the right to change the contents of this document without prior notice.