

2MP HD IR Fixed Dome Network Camera

IPC-D122-PF28K



Features

- High quality image with 1080P, 1/2.9" CMOS sensor
- 1080P (1920 × 1080)@25/20 fps; 720P (1280 × 720)@25/20 fps
- Ultra 265, H.265, H.264
- 2D/3D DNR (digital noise reduction)
- ROI (region of interest) ensures image quality in areas of interest with low bandwidth
- Smart IR, up to 30 m (98.4 ft.) IR distance
- MicroSD, up to 128 GB
- 2-axis
- Wide temperature range: -30 °C to 60 °C (-22 °F to 140 °F)
- DC 12 V, PoE (IEEE 802.3af) power supply
- IP67
- IK10

Specifications

Model	IPC-D122-PF28K
Camera	
Max Resolution	2 MP
Sensor	1/2.9" CMOS
Min. Illumination	Color: 0.02 Lux (F2.1, AGC ON), 0 Lux with IR on
Day/Night	IR-cut filter with auto switch (ICR)
Shutter	Auto/Manual, 1 ~ 1/100000s
Adjustment Angle	Pan: 3° to 360°, Tilt: 0° to 75°
S/N	>52 dB
WDR	DWDR
Lens	
Focal Length	2.8 mm
Iris Type	Fixed
Iris	F2.1
Field of View (H)	101.1°
Field of View (V)	55.0°
Field of View (D)	111.0°
DORI	
DORI Distance (Lens)	2.8 mm
DORI Distance (Detect)	45.0 m (147.6 ft.)
DORI Distance (Observe)	18.0 m (59.1 ft.)
DORI Distance (Recognize)	9.0 m (29.5 ft.)
DORI Distance (Identify)	4.5 m (14.8 ft.)
Illuminator	
Supplemental Light	IR
Illumination Distance (IR)	Up to 30m (98ft)
Wavelength	850 nm
IR On/Off Control	Auto/Manual
Video	
Video Compression	Ultra 265, H.265, H.264
H.264 Code Profile	Baseline profile, Main profile, High profile
Frame Rate	Main Stream: 1080P (1920 × 1080), max. 25 fps; 720P (1280 × 720), max. 25 fps; Sub Stream: D1 (720 × 576), max. 25 fps; 640 × 360, max. 25 fps; 2CIF (704 × 288), max. 25 fps; CIF (352 × 288), max. 25 fps;
Video Bit Rate	128 Kbps to 6144 Kbps
U-code	Support
OSD	Up to 4 OSDs
Privacy Mask	Up to 4 areas
ROI	Up to 8 areas
Video Stream	Dual streams







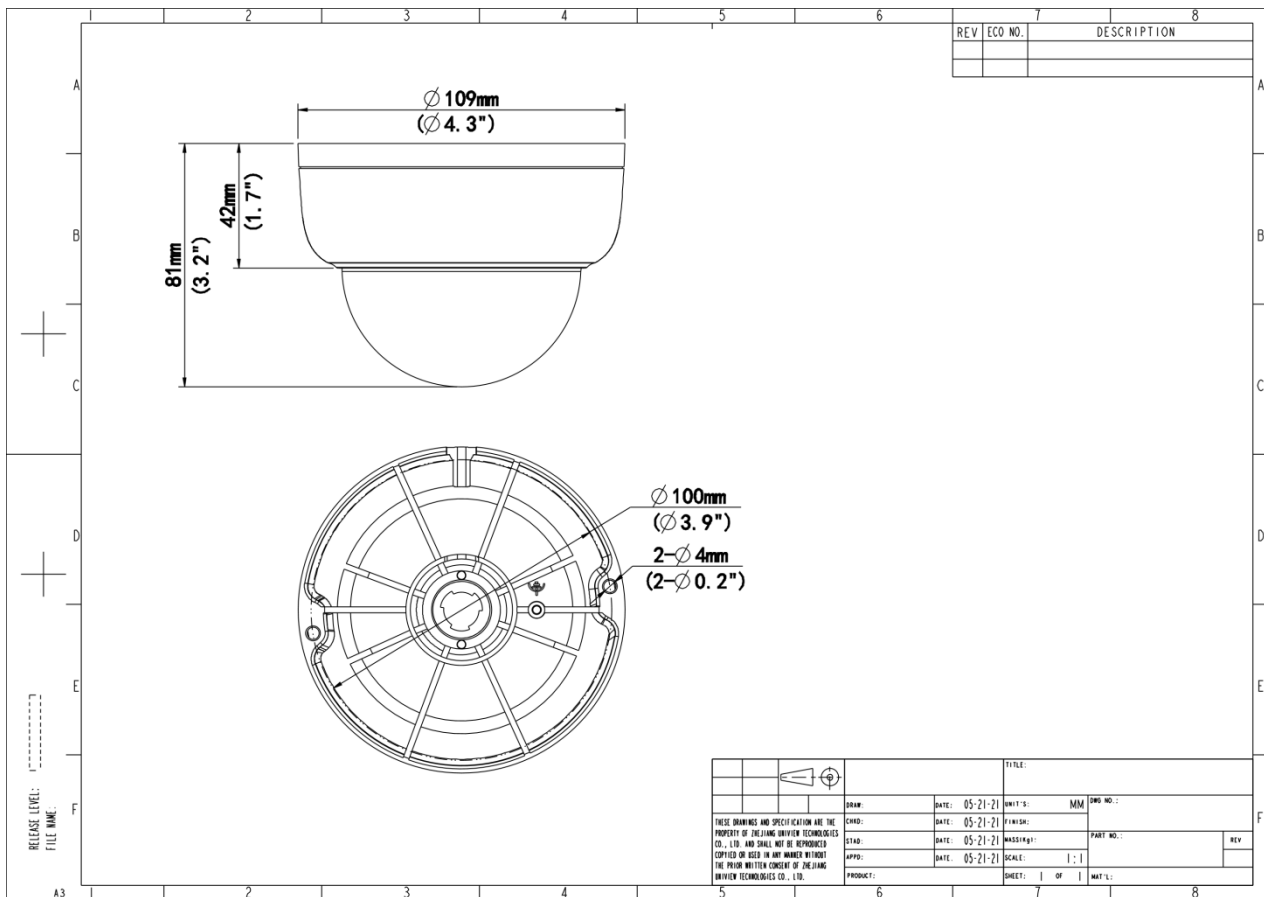





Image	
White Balance	Auto, Outdoor, Fine tune, Sodium lamp, Locked, Auto2
Digital Noise Reduction	2D/3D DNR
Smart IR	Support
Flip	Normal, Flip vertical, Flip horizontal, 180°
Dewarping	N/A
HLC	Support
BLC	Support
Defog	Digital defog
Events	
Basic Detection	Motion detection
General Function	Watermark, IP address filtering, Access policy, ARP protection, RTSP authentication, User authentication, HTTP authentication
Storage	
Edge Storage	MicroSD, up to 512 GB
Network Storage	ANR
Network	
Protocols	IPv4, IGMP, ICMP, TCP, UDP, DHCP, RTP, RTSP, RTCP, RTMP, DNS, DDNS, NTP, UPnP, HTTP, HTTPS, QoS
Compatible Integration	ONVIF (Profile S, Profile G, Profile T), API
User/Host	Up to 32 users, 2 user levels: administrator and common user
Client	APP, Uniarch client
Web Browser	Plug-in required live view: IE 10+, Chrome 45+, Firefox 52+, Edge 79+, Plug-in free live view: Chrome 57+, Firefox 58+, Edge 16+
Interface	
Audio I/O	N/A
Alarm I/O	N/A
Built-in Mic	N/A
Built-in Speaker	N/A
WIFI	N/A
Network	1 × RJ45 10 M/100 M Base-TX Ethernet
Video Output	N/A
Certification	
EMC	CE-EMC (EN 55032, EN 61000-3-3, EN IEC 61000-3-2, EN 55035) FCC (FCC 47 CFR part15 B)
Safety	CE LVD (EN 62368-1) CB (IEC 62368-1)
Environment	CE-RoHS (2011/65/EU;(EU)2015/863); WEEE (2012/19/EU);
Protection	IP67 (IEC 60529) IK10 (IEC 62262)
General	
Power	DC 12 V±25%, PoE (IEEE 802.3af) Power consumption: Max. 3.3 W

Power Interface	Ø5.5 mm coaxial power plug
Dimensions	Ø109 mm × 81 mm (Ø4.3" × 3.2") (Ø × H)
Weight	0.36 kg (0.79 lb.)
Material	Metal + Plastic
Storage Environment	-30 °C to 60 °C (-22 °F to 140 °F), Humidity: ≤ 95% RH (non-condensing)
Working Environment	-30 °C to 60 °C (-22 °F to 140 °F), Humidity: ≤ 95% RH (non-condensing)
Surge Protection	4 KV
Reset Button	N/A

Dimensions



Accessories

<p>TR-JB03-G-IN Junction Box for Mini Fix-dome(Support wiring from behind)</p>	<p>HS-205S Sunshade Shell for Fixed Focus Dome</p>	<p>TR-UM06-E-IN Slant Mounting Bracket for Fixed Dome</p>
		
<p>TR-A01-IN NPT 3/4" Waterproof Cable Gland</p>	<p>TR-SE24-IN Dome Pendent Mounting Pole 200mm</p>	<p>TR-SE24-A-IN Dome Pendent Mounting Pole 500mm</p>
		
<p>TR-CM24-IN Dome Pendent Mounting Bracket(Indoor)</p>	<p>TR-JB07/WM03-G-IN-V2 Wall Mounting Assembling Bracket For 32 Fix-dome&Mini Fix-dome&Plastic Turret Camera</p>	<p>TR-WM03-D-IN-V2 Wall Mounting Bracket for 32 Fix-dome&Mini Fix-dome&Plastic Turret Camera</p>
		
<p>TR-UC08-C-V2 Bullet&Dome Corner Mounting Bracket</p>	<p>TR-UP06-C-IN-V2 Pole Mounting Bracket for Bullet Junction Box Only</p>	<p>TR-FM116 In-ceiling Bracket for Fix-dome</p>
		
<p>TR-WM07P-B Dome Wall Mounting Plastic Bracket</p>		
		

Zhejiang Uniview Technologies Co., Ltd.



<http://www.uniview.com>



overseasbusiness@uniview.com; globalsupport@uniview.com



No. 369, Xietong Road, Xixing Sub-district, Binjiang District, Hangzhou City, 310051, Zhejiang Province, China



©2023-2025 Zhejiang Uniview Technologies Co., Ltd. All rights reserved.

*Product specifications and availability are subject to change without notice.

*Despite our best efforts, technical or typographical errors may exist in this document.

Uniview cannot be held responsible for any such errors and reserves the right to change the contents of this document without prior notice.