

4MP+4MP LightHunter Dual-lens Network PTZ Camera IPC94144SFW-X25-F40C



Features

- Fixed camera and PTZ camera integration, dual-channel with one IP, provides overall view and detailed view at the same time
- Ultra 265, H.265, H.264, MJPEG
- 25X optical zoom of PTZ channel allows for closer viewing of subjects
- Smart intrusion prevention, supports false alarm filtering, including cross line, intrusion, enter area, leave area detection
- automatic selection of best snapshots, supports face detection masked area
- People counting, supports people flow counting and crowd density monitoring, suitable for different statistical scenarios
- PTZ channel can be linked to fixed channel's smart intrusion prevention to track the objects triggering the rule
- Supports sound and light warning, makes warning and alarming more noticeable
- LightHunter technology ensures ultra-high image quality in low illumination environment
- IR and warm light illumination to deal with different scenes and achieve full-color illumination
- DC 12 V, PoE+ (IEEE 802.3at) power supply
- Alarm I/O: 2/1, audio I/O: 1/1

Specifications

Channel	Channel 1 (Panorama)	Channel 2 (Detail)
Camera		
Sensor	1/1.8" CMOS	1/2.7" CMOS
Min. Illumination	Color: 0.0005 Lux (F1.0, AGC ON), 0 lux with IR	Color: 0.003 Lux (F1.5, AGC ON), 0 lux with IR
Day/Night	IR-cut filter with auto switch (ICR)	
Shutter	Auto/Manual, 1 to 1/100000 s	
WDR	120 dB	
S/N	>56 dB	
Lens		
Focal Length	4.0 mm	4.8 to 120 mm
Optical Zoom	N/A	25X
Iris	F1.0	F1.5 to F3.8
Field of View (H)	94.9°	55.46° to 3.09°
Field of View (V)	51.5°	32.94° to 1.73°
Field of View (D)	116.7°	68.22° to 3.80°
DORI		
DORI Distance (Detect)	90.0 m (295.3 ft.)	123.8 m to 2475.0 m (406.0 ft. to 8120.1 ft.)
DORI Distance (Observe)	36.0 m (118.1 ft.)	43.2 m to 1080.0 m (141.7 ft. to 3543.3ft.)
DORI Distance (Recognize)	18.0 m (59.1 ft.)	21.6 m to 540 m (70.9 ft. to 1771.7 ft.)
DORI Distance (Identify)	9.0 m (29.5 ft.)	10.8 m to 270 m (35.4 ft. to 885.8 ft.)
Video		
Privacy Mask	Up to 4 areas	24 areas, up to 4 areas per scene
Frame Rate-Main Stream	4 MP (2688 × 1520)@25 fps (Default) 4 MP (2688 × 1520), max. 30 fps; 4 MP (2560 × 1440), max. 30 fps; 1080P (1920 × 1080), max. 30 fps; 720P (1280 × 720), max. 30 fps; D1 (720 × 576), max. 30 fps; 640 × 360, max. 30 fps;	
Frame Rate-Sub Stream	720P (1280 × 720), max. 30 fps; D1 (720 × 576), max. 30 fps; 640 × 360, max. 30 fps	1080P (1920 × 1080), max. 30 fps; 720P (1280 × 720), max. 30 fps; D1 (720 × 576), max. 30 fps; 640 × 360, max. 30 fps
Frame Rate-Third Stream	D1 (720 × 576), max. 30 fps; 640 × 360, max. 30 fps; 2CIF (704 × 288), max. 30 fps; CIF (352 × 288), max. 30 fps	
Video Compression	Ultra 265, H.265, H.264, MJPEG	
Frame Rate	Main Stream: 4 MP (2688 × 1520), max. 30 fps; Sub Stream: 720P (1280 × 720), max. 30 fps; Third Stream: D1 (720 × 576), max. 30 fps	Main Stream: 4 MP (2688 × 1520), max. 30 fps; Sub Stream: 1080P (1920 × 1080), max. 30 fps; Third Stream: D1 (720 × 576), max. 30 fps

Frame Rate Recommendation	2688 × 1520@30 fps + 720P@30 fps + D1@16 fps	2688 × 1520@30 fps + 1080P@30 fps + D1@16 fps
	2688 × 1520@30 fps + 720P@25 fps + D1@30 fps	2688 × 1520@30 fps + 1080P@25 fps + D1@30 fps
	2688 × 1520@25 fps + 720P@25 fps + D1@25 fps	2688 × 1520@25 fps + 1080P@25 fps + D1@25 fps
	2560 × 1440@30 fps + 720P@30 fps + D1@30 fps	2560 × 1440@30 fps + 1080P@30 fps + D1@30 fps
	2560 × 1440@30 fps + 720P@25 fps + D1@30 fps	2560 × 1440@30 fps + 1080P@25 fps + D1@30 fps
	2560 × 1440@25 fps + 720P@25 fps + D1@25 fps	2560 × 1440@25 fps + 1080P@25 fps + D1@25 fps
	1080P@30 fps + 720P@30 fps + D1@30 fps	1080P@30 fps + 1080P@30 fps + D1@30 fps
	1080P@25 fps + 720P@25 fps + D1@25 fps	1080P@25 fps + 1080P@25 fps + D1@25 fps
	Video Bit Rate	128 Kbps to 16 Mbps
U-code	Support	
ROI	Support	
Video Stream	Triple streams	
OSD	Up to 8 OSDs	
Image		
White Balance	Auto, Outdoor, Fine tune, Sodium lamp, Locked, Auto2	
Digital Noise Reduction	2D/3D DNR	
Flip	Normal, Flip vertical, Flip horizontal, 180°	
HLC	Support	
BLC	Support	
Smart IR	Support	
Defog	Digital defog	
Heatwave Reduction	Support	
Illuminator		
Light On/Off Control	Auto/Manual	
Wavelength	N/A	850 nm
Illumination Distance (IR)	N/A	100 m (328.1 ft.)
Illumination Distance (Warm Light)	30 m (98.4 ft.)	N/A
Supplemental Light	Warm light	
Events		
Basic Detection	Motion detection, Audio detection, Tampering alarm	
General Function	Watermark, IP address filtering, Access policy, ARP protection, RTSP authentication, User authentication, Alarm input, Alarm output	
UMD (Ultra Motion Detection)	Support	
Intelligent		
Linkage Function	Support. Triggered by fixed lens via smart intrusion prevention function to track target	N/A





Smart Intrusion Prevention	Cross line detection, intrusion detection (support false alarm filtering and the classification of human, non-motor vehicle and vehicle)	
People Counting	Support people flow counting and crowd density detection	
Exception Detection	Object Left Behind, Object removed, Scene change	Object Left Behind, Object removed
Audio		
Audio Compression	G.711U, G.711A	
Audio Bitrate	128 Kbps	
Two-way Audio	Support	
Suppression	Support	
Sampling Rate	16 kHz	
Storage		
Edge Storage	MicroSD, up to 512 GB	
Network Storage	ANR	
Network		
Protocols	SSH, IGMP, RTP, RTCP, SMTP, IPv4, IPv6, ICMP, ARP, TCP, UDP, DHCP, PPPoE, RTSP, RTMP, DNS, DDNS, NTP, FTP, UPnP, HTTP, HTTPS, 802.1x, SNMP, QoS, SSL/TLS	
Compatible Integration	ONVIF (Profile S, Profile G, Profile T, Profile M), API, SDK	
User/Host	Up to 32 users. 3 user levels: administrator, common user and operator	
Security	TLS 1.3, Password Protection, Strong Password, HTTPS Encryption, Export Operation Logs, Basic and Digest Authentication for RTSP, Digest Authentication for HTTP, TLS 1.2, WSSE and Digest Authentication for ONVIF	Password Protection, Strong Password, HTTPS Encryption, Export Operation Logs, Basic and Digest Authentication for RTSP, Digest Authentication for HTTP, TLS 1.2, WSSE and Digest Authentication for ONVIF, TLS 1.3
Client	EZStation, UNV-Link, UNV-Link Pro	
Web Browser	Plug-in required live view: IE 10+, Chrome 45+, Firefox 52+, Edge 79+	
PTZ		
Number of Presets	N/A	1024
Preset Patrol	N/A	16 patrols, up to 64 presets for each patrol
Route Patrol	N/A	16 patrols, up to 32 actions for each patrol
Recorded Patrol	N/A	16 patrols, up to 128 actions for each patrol
Patrol Stay Time	15 s to 1800 s	
Preset Image Freeze	N/A	
Home Position	N/A	Support
Number of Presets (IPC)	N/A	1024
Pan Range	N/A	360°
Tilt Range	18°±5°	-15° to 90°
Pan Speed	N/A	0.1°/s to 80°/s
Tilt Speed	N/A	0.1°/s to 80°/s
Interface		
Audio I/O	1 Input: impedance 1 kΩ, amplitude 2.5 V [p-p], 1 Output: impedance 600 Ω, amplitude 2.5 V [p-p]	
Alarm I/O	2/1	

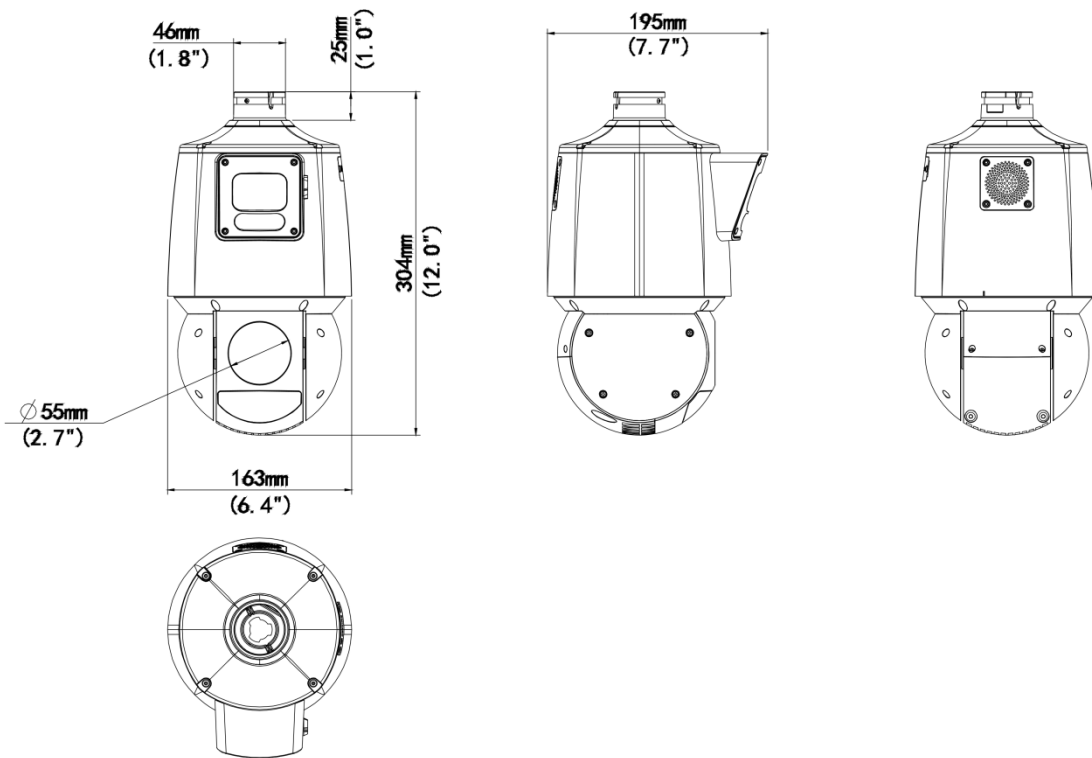





Serial Port	1 × RS485
Built-in Mic	N/A
Built-in Speaker	Support
WIFI	N/A
Network	1 × RJ45 10 M/100 M Base-TX Ethernet
Video Output	N/A
Certification	
EMC	CE-EMC (EN 55032: 2015+A1: 2020, EN 61000-3-3: 2013+A1: 2019, EN IEC 61000-3-2: 2019+A1: 2021, EN 55035: 2017+A11: 2020) FCC (FCC CFR 47 part15 B, ANSI C63.4-2014)
Safety	CE LVD (EN 62368-1: 2014+A11: 2017) UL (UL 62368-1, 2nd Ed , Issue Date: 2014-12-01)
Environment	CE-RoHS (2011/65/EU; (EU) 2015/863)
Protection	IP66 (IEC 60529 : 1989+AMD1: 1999+AMD2: 2013)
General	
Power	DC 12 V (±25%), PoE+ (IEEE 802.3at)
Power Consumption	Max. 24 W
Power Interface	Ø5.5 mm coaxial power plug
Dimensions	304 mm × 195 mm × 163 mm (12.0" × 7.7" × 6.4") (L × W × H)
Weight	2.27 kg (5.00 lb.)
Working Environment	-40 °C to 65 °C (-40 °F to 149 °F), Humidity: ≤ 95% RH (non-condensing)
Storage Environment	-40 °C to 70 °C (-40 °F to 158 °F), Humidity: ≤ 95% RH (non-condensing)
Surge Protection	4 KV
Reset Button	Support
Web Client Language	22 Languages: Traditional Chinese, English, Simplified Chinese, Polish, German, Russian, French, Korean, Dutch, Czech, Portuguese (Europe), Portuguese (Brazil), Japanese, Thai, Turkish, Spanish (Latin America), Spanish (Europe), Hungarian, Italian, Vietnamese, Arabic, Slovak

Dimensions



Accessories

TR-UF45-A-IN Dome Indoor Ceiling Mounting Pedestal	TR-SE45-A-IN Dome Ceiling Mounting Pole 500	TR-SE45-IN Dome Ceiling Mounting Pole 200
		
TR-CE45-IN Dome Indoor Ceiling Mounting Bracket	TR-WE45-IN Dome Wall Mounting Bracket	TR-WE45-A-IN Long Wall Mounting Bracket for Dome
		

<p>TR-WE45-B-IN Dome Gooseneck Bracket</p>	<p>TR-JB12-IN Dome Junction Box</p>	<p>TR-UP08-A-IN Dome Pole Mounting Bracket</p>
		
<p>TR-UP08-B-IN Aluminium Alloy Pole Mounting Bracket</p>	<p>TR-UC08-A-IN Dome Corner Mounting Bracket</p>	<p>TR-UC08-B-IN Aluminium Alloy Corner Mounting Bracket</p>
		

Unlimited New View

Zhejiang Uniview Technologies Co., Ltd.



<http://www.uniview.com>



overseasbusiness@uniview.com; globalsupport@uniview.com



No. 369, Xietong Road, Xixing Sub-district, Binjiang District, Hangzhou City, 310051, Zhejiang Province, China



©2023-2025 Zhejiang Uniview Technologies Co., Ltd. All rights reserved.

*Product specifications and availability are subject to change without notice.

Despite our best efforts, technical or typographical errors may exist in this document. Uniview cannot be held responsible for any such errors and reserves the right to change the contents of this document without prior notice.