

## 2MP HD IR Fixed Eyeball Network Camera IPC3612LB-ADF28(40)K-K



## Features

- High quality image with 2MP, 1/2.8" CMOS sensor
- 2MP (1920 × 1080)@30/25 fps; 720P (1280 × 720)@30/25 fps
- Ultra 265, H.265, H.264, MJPEG
- 120 dB true WDR technology enables clear image in strong light scene
- Support 9:16 Corridor Mode
- Smart IR, up to 30 m (98 ft) IR distance
- Built in Mic
- Supports up to 512 GB Micro SD Card
- IP67 protection
- Support PoE power supply
- 3 Axis

## Specifications

Model	IPC3612LB-ADF28K-K	IPC3612LB-ADF40K-K
<b>Camera</b>		
Max Resolution	2 MP	
Sensor	1/2.8" CMOS	
Min. Illumination	Color: 0.01 Lux (F2.0, AGC ON), 0 Lux with IR	
Day/Night	IR-cut filter with auto switch (ICR)	
Shutter	Auto/Manual, 1 ~ 1/100000s	
Adjustment Angle	Pan: 0° to 360°, Tilt: 0° to 80°, Rotate: 0° to 360°	
S/N	>52 dB	
WDR	120 dB	
<b>Lens</b>		
Focal Length	2.8 mm	4.0 mm
Iris	F2.0	
Field of View (H)	112.9°	91.2°
Field of View (V)	59.1°	47.9°
Field of View (D)	121.2°	95.9°
Iris Type	Fixed	
<b>DORI</b>		
DORI Distance (Lens)	2.8 mm	4 mm
DORI Distance (Detect)	42.0 m (137.8 ft.)	60.0 m (196.9 ft.)
DORI Distance (Observe)	16.8 m (55.1 ft.)	24.0 m (78.7 ft.)
DORI Distance (Recognize)	8.4 m (27.6 ft.)	12.0 m (39.3 ft.)
DORI Distance (Identify)	4.2 m (13.8 ft.)	6.0 m (19.7 ft.)
<b>Illuminator</b>		
Supplemental Light	IR	
Illumination Distance (IR)	30 m (98.4 ft.)	
Wavelength	850 nm	
IR On/Off Control	Auto/Manual	
<b>Video</b>		
Video Compression	Ultra 265, H.265, H.264, MJPEG	
H.264 Code Profile	Baseline profile, Main profile, High profile	
Frame Rate	Main Stream: 1080P (1920 × 1080), max. 30 fps; 720P (1280 × 720), max. 30 fps; Sub Stream: 720P (1280 × 720), max. 30 fps; D1 (720 × 576), max. 30 fps; 640 × 360, max. 30 fps; 2CIF (704 × 288), max. 30 fps; CIF (352 × 288), max. 30 fps;	
Video Bit Rate	128 Kbps to 6144 Kbps	
OSD	Up to 4 OSDs	
Privacy Mask	Up to 4 areas	
ROI	Support	
U-code	Support	
Video Stream	Dual streams	
<b>Image</b>		







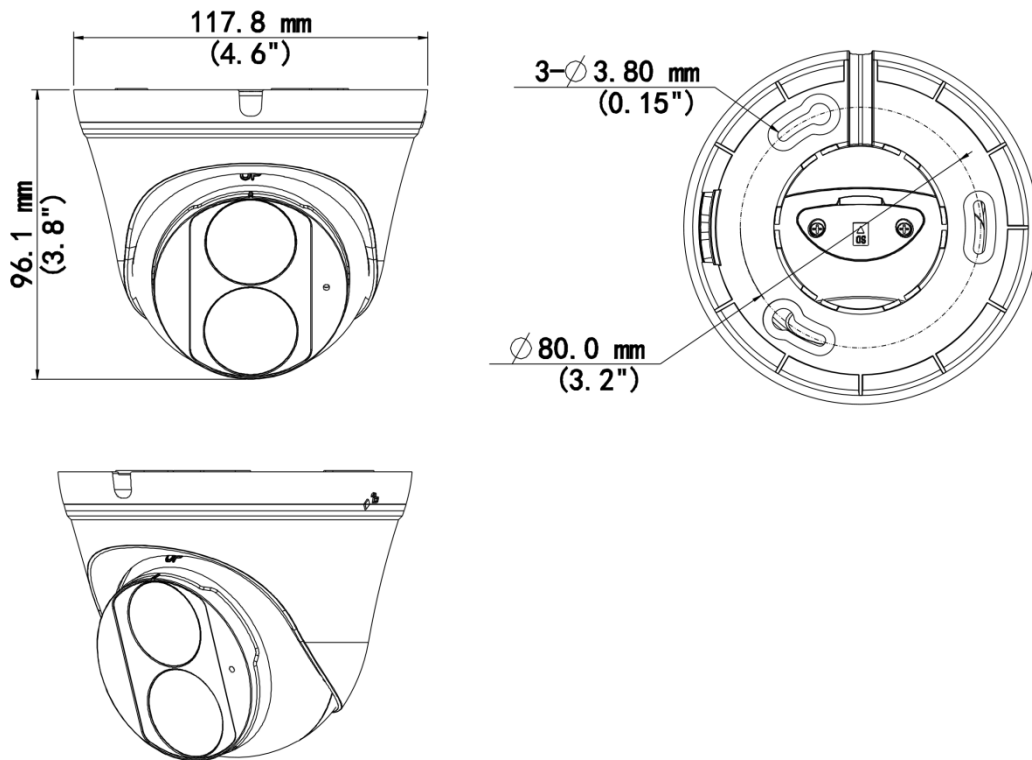



White Balance	Auto, Outdoor, Fine tune, Sodium lamp, Locked, Auto2
Digital Noise Reduction	2D/3D DNR
Smart IR	Support
Flip	Normal, Flip vertical, Flip horizontal, 180°, 90° Clockwise, 90° Anti-clockwise
HLC	Support
Dewarping	N/A
BLC	Support
Defog	Digital defog
<b>Audio</b>	
Audio Compression	G.711U, G.711A
Audio Bitrate	64 Kbps
Two-way Audio	N/A
Suppression	Support
Sampling Rate	8 kHz
<b>Events</b>	
Basic Detection	Motion detection, Ultra motion detection, Tampering alarm, Audio detection, Cross line (based on human body detection), Intrusion (based on human body detection)
General Function	Watermark, IP address filtering, Access policy, ARP protection, RTSP authentication, User authentication
<b>Storage</b>	
Edge Storage	MicroSD, up to 512 GB
Network Storage	ANR, NAS (NFS)
<b>Network</b>	
Protocols	IPv4, IGMP, ICMP, ARP, TCP, UDP, DHCP, RTP, RTSP, RTCP, RTMP, DNS, DDNS, NTP, FTP, UPnP, HTTP, HTTPS, SMTP, QoS, SSL/TLS, SNMP, IPv6
Compatible Integration	ONVIF (Profile S, Profile G, Profile T), API, SDK
Client	EZStation, APP
Web Browser	Plug-in required live view: IE 10+, Chrome 45+, Firefox 52+, Edge 79+, Plug-in free live view: Chrome 57+, Firefox 58+, Edge 16+
Security	Password Protection, Strong Password, HTTPS Encryption, Export Operation Logs, Basic and Digest Authentication for RTSP, Digest Authentication for HTTP, TLS 1.2, WSSE and Digest Authentication for ONVIF
User/Host	Up to 32 users. 3 user levels: administrator, common user and operator
<b>Interface</b>	
Audio I/O	N/A
Serial Port	N/A
Alarm I/O	N/A
Built-in Mic	Support
Built-in Speaker	N/A
WIFI	N/A
Network	1 × RJ45 10 M/100 M Base-TX Ethernet
Video Output	N/A
<b>Certification</b>	

Protection	IP67 (IEC 60529)
EMC	CE-EMC (EN 55032, EN 61000-3-3, EN IEC 61000-3-2, EN 55035) FCC (FCC 47 CFR part15 B)
Safety	CE LVD (EN 62368-1) CB (IEC 62368-1) UL/CUL (UL 62368-1, CAN/CSA C22.2 No. 62368-1)
Environment	CE-RoHS (2011/65/EU;(EU)2015/863); WEEE (2012/19/EU);
General	
Power	DC 12 V±25%, PoE (IEEE 802.3af)
Power Consumption	Max. 3.5 W
Power Interface	Ø5.5 mm coaxial power plug
Dimensions	Ø118 mm × 96 mm (Ø4.6" × 3.8") (Ø × H)
Material	Graphene + Plastic
Weight	0.27 kg (0.60 lb.)
Storage Environment	-40 °C to 70 °C (-40 °F to 158 °F), Humidity: ≤ 95% RH (non-condensing)
Working Environment	-30 °C to 60 °C (-22 °F to 140 °F), Humidity: ≤ 95% RH (non-condensing)
Surge Protection	4 KV
Web Client Language	4 Languages: English, Russian, Spanish, Vietnamese
Reset Button	N/A

## Dimensions



## Accessories

<p><b>TR-JB03-I-IN</b> Junction Box for Turret Camera(Support wiring from behind)</p>	<p><b>TR-A01-IN</b> NPT 3/4" Waterproof Cable Gland</p>	<p><b>TR-SE24-IN</b> Dome Pendant Mounting Pole 200mm</p>
		
<p><b>TR-SE24-A-IN</b> Dome Pendant Mounting Pole 500mm</p>	<p><b>TR-CM24-IN</b> Dome Pendant Mounting Bracket(Indoor)</p>	<p><b>TR-WM07P-B</b> Dome Wall Mounting Plastic Bracket</p>
		
<p><b>TR-UC08-C-V2</b> Bullet&amp;Dome Corner Mounting Bracket</p>	<p><b>TR-UP06-C-IN-V2</b> Pole Mounting Bracket for Bullet Junction Box Only</p>	<p><b>TR-WM03-D-IN-V2</b> Wall Mounting Bracket for 32 Fix-dome&amp;Mini Fix-dome&amp;Plastic Turret Camera</p>
		
<p><b>TR-JB07/WM03-G-IN-V2</b> Wall Mounting Assembling Bracket For 32 Fix-dome&amp;Mini Fix-dome&amp;Plastic Turret Camera</p>		
		

# Unlimited New View

## Zhejiang Uniview Technologies Co., Ltd.



<http://www.uniview.com>



[overseasbusiness@uniview.com](mailto:overseasbusiness@uniview.com); [globalsupport@uniview.com](mailto:globalsupport@uniview.com)



No. 369, Xietong Road, Xixing Sub-district, Binjiang District, Hangzhou City, 310051, Zhejiang Province, China



©2023-2025 Zhejiang Uniview Technologies Co., Ltd. All rights reserved.

\*Product specifications and availability are subject to change without notice.

Despite our best efforts, technical or typographical errors may exist in this document. Uniview cannot be held responsible for any such errors and reserves the right to change the contents of this document without prior notice.