

2MP LightHunter PoC Fixed IR Turret Analog Camera UAC-T122-APF28LM



Overview

UAC-T122-APF28LM is a 2MP LightHunter PoC fixed IR turret analog camera with a high-performance 1/2.9-inch CMOS sensor and 3D noise reduction technology. It supports TVI/AHD/CVI/CVBS, which effectively enhances product adaptability and diversity of networking solutions. With SYV-75-3 or other coaxial cable types, the camera can achieve low-cost, long-distance, and anti-interference mega-pixel HD video transmission without time delay. In addition, the PoC power supply system can achieve video and power transmission on one cable, simplifying wiring and installation work, and improving structural flexibility. It supports IR-cut filter with auto-switch (ICR) and provides color images at daytime and black/white images at night. The camera also supports audio input and synchronous transmission of audio and video.

Features

- * Coaxial cables are recommended for video signal transmission, such as SYV-75-3, SYV-75-5, or RG59 cables.
- * To achieve power supply on the coaxial cable, please use the camera with our PoC series XVRs.
- High quality imaging with 2MP resolution
- TVI/AHD/CVI/CVBS
- Supports IR-cut filter with auto-switch (ICR)
- LightHunter monitoring with high-sensitivity sensor
- 3D noise reduction technology delivers clean and sharp images
- Supports 180° horizontal flip, 180° vertical flip
- OSD configuration menu, easy to operate
- IP67 waterproof and dustproof design, high reliability

- OSD configuration menu in 11 languages
- Built-in microphone for high quality audio transmission via coaxial cables
- Supports digital defog
- 3-Axis
- Support PoC power supply

Specifications





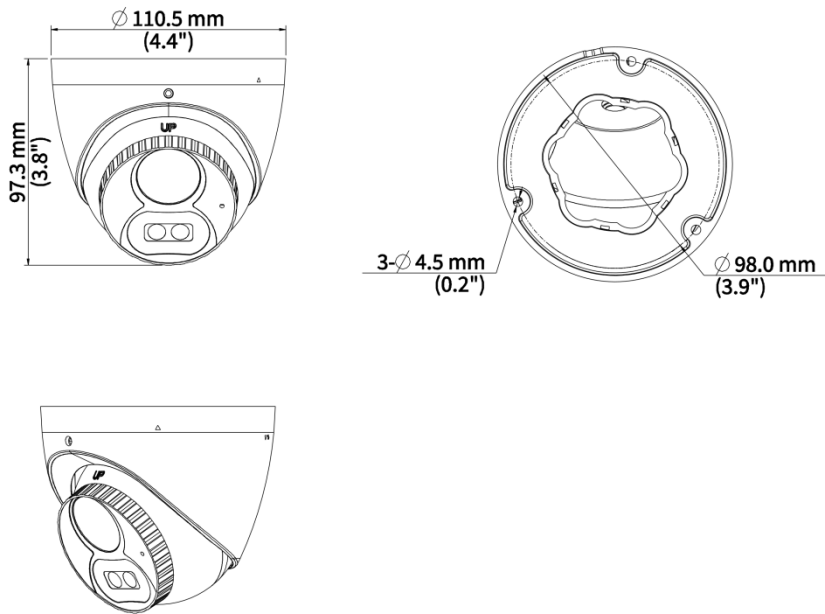

Model	UAC-T122-APF28LM
Camera	
Max Resolution	2 MP
Sensor Size	1/2.9" CMOS
Min. Illumination	0.005 lux (F1.6, AGC ON) 0 lux (IR on)
Lens	
Focus	2.8 mm
Lens Mount	M12
Angle of View (H)	101.5°
Angle of View (V)	56.9°
Angle of View (D)	117.4°
Illuminator	
Illuminator Number	Two IR illuminators
Illumination Distance	40m
Lifetime	≥ 60000 hours
Video	
Resolution	1080P: 1920(H)×1080(V) 720P: 1280(H) ×720(V)
Frame Rate	TVI/AHD/CVI: 1080P@25fps(default), 1080P@30fps; 720P@25fps, 720P@30fps CVBS: PAL, NTSC
Shutter Time	PAL: 1/25s-1/50000s, NTSC: 1/30s-1/50000s
Image	
Exposure Mode	Four modes: Global (default), BLC, HLC, DWDR
Day/Night	Three modes: Auto (default), Day, Night
Digital Noise Reduction	2D/3D
White Balance	Two modes: Auto (default), Manual
WDR	DWDR
Smart IR	Support
Flip	Supports 180°horizontal flip, 180°vertical flip
Digital Defog	Support
Audio	
Built-in Mic	Support
Camera Audio	TVI: 1080P@25fps, 1080P@30fps CVI: 1080P@25fps, 1080P@30fps











	* Audio function of the POC series camera is only available when the camera is used with our POC series XVRs.
Interface	
Power Interface	5.5 mm Power Interface
Video Output	BNC, supports TVI/AHD/CVI/CVBS
Operating Environment	
Temperature	-30°C to 60°C (-22°F to 140°F)
Humidity	≤ 95% RH (non-condensing)
Surge Protection	4 KV for power, 4 KV for video output interfaces
General	
Power	DC 12 V±25%/PoC
Power Consumption	MAX 3.2W
Mount	Wall Mount, Pole Mount, Corner Mount, Pendant Mount
Dimensions	Φ111mm*98mm (diameter*height)
Material	Metal + Plastic
Weight	334g (0.74lb)
OSD Menu Language	11 Languages: English, German, Spanish (Latin America), French, Italian, Japanese, Korean, Polish, Portuguese (Brazil), Russian, Turkish
Certification	
EMC	CE-EMC (EN 55032, EN 61000-3-3, EN IEC 61000-3-2, EN 55035), FCC (FCC 47 CFR part15 B)
Safety	CE-LVD (EN 62368-1)
Environment	CE-RoHS (2011/65/EU; (EU) 2015/863); WEEE (2012/19/EU)
Protection	IP67 (IEC 60529)

Dimensions



Accessories

<p>TR-JB03-G-IN Junction Box for Mini Fix-dome(Support wiring from behind)</p>	<p>TR-SE24-A-IN Dome Pendant Mounting Pole 500mm</p>	<p>TR-SE24-IN Dome Pendant Mounting Pole 200mm</p>
		
<p>TR-CM24-IN Dome Pendant Mounting Bracket(Indoor)</p>	<p>TR-A01-IN NPT 3/4" Waterproof Cable Gland</p>	<p>TR-JB07/WM03-G-IN-V2 Wall Mounting Assembling Bracket For 32 Fix-dome&Mini Fix-dome&Plastic Turret Camera</p>
		

<p>TR-WM03-D-IN-V2 Wall Mounting Bracket for 32 Fix-dome&Mini Fix-dome&Plastic Turret Camera</p>	<p>TR-UC08-C-V2 Bullet&Dome Corner Mounting Bracket</p>	<p>TR-UP06-C-IN-V2 Pole Mounting Bracket for Bullet Junction Box Only</p>
		
<p>PWR-DC1201A-UK DC12V/1A Wall Plug British Standard Power Adapter</p>	<p>PWR-DC1201B-UK UNV DC12V/1A Wall Plug British Standard Power Adapter(Colorful Bag)</p>	<p>PWR-DC1201A-US DC12V/1A Wall Plug American Standard Power Adapter</p>
		
<p>PWR-DC1201B-US UNV DC12V/1A Wall Plug American Standard Power Adapter(Colorful Bag)</p>	<p>PWR-DC1201A-EU DC12V/1A Wall Plug European Standard Power Adapter</p>	<p>PWR-DC1201B-EU UNV DC12V/1A Wall Plug European Standard Power Adapter(Colorful Bag)</p>
		
<p>PWR-DC1201A-IND UNV DC12V/1A Wall Plug Indian Standard Power Adapter-Colorful Bag</p>		
		

Unlimited New View

Zhejiang Uniview Technologies Co., Ltd.



<http://www.uniview.com>



overseasbusiness@uniview.com; globalsupport@uniview.com



No. 369, Xietong Road, Xixing Sub-district, Binjiang District, Hangzhou City, 310051, Zhejiang Province, China



©2023-2025 Zhejiang Uniview Technologies Co., Ltd. All rights reserved.

*Product specifications and availability are subject to change without notice.

Despite our best efforts, technical or typographical errors may exist in this document. Uniview cannot be held responsible for any such errors and reserves the right to change the contents of this document without prior notice.