

Villa Door Station

OEU-202S-HMK2



Overview

OEU-202S-HMK2 villa door station is one of the terminal equipment of the digital building intercom system, with functions of video intercom, security alarm, video surveillance, etc., providing a safe and comfortable living environment for residents. It can be widely used in villa building system.

Features

- Optional recess box for recess mount.
- Supports power output, which can be enabled or disabled on the Web interface.
- Built-in heating module supports operation at a very low temperature.
- Metal casing.
- Supports batch configuration.
- Supports call and intercom with the connected indoor stations and apps.
- Supports video monitoring, security alarm, and tamper alarm.
- Built-in IC card reader.

Specifications

Model	OEU-202S-HMK2
Specification Index	

Card Capacity	10000
Maximum Connected Indoor Station	20
Basic Business	
WDR	Support DWDR
Protocol	Private protocol
Button	2 x Call button
Hardware Specification	
FOV	Horizontal: 106.9° Vertical: 56.9° Diagonal: 127.9°
Power Consumption	PoE: 6.48W DC12V: 5.35W
Volume Adjustment	Support
Audio Compression Bitrate	128Kbps
Audio Output	1 x Built-in speaker
Audio Input	1 x Built-in omnidirectional microphone
Audio Quality	Noise suppression, echo cancellation, AGC
Protection Level	IP65 (Apply waterproof glue to the gap between the device and the wall. See the corresponding quick guide for details) IK08
Weight	675g
Mount Method	Wall mount
Interface	Power*1, network port*1, RS485*1, Wiegand*1, IO input*4, door lock*2 (support electric lock/door magnet), tamper button*1
Network	100Mbps network port, supports IEEE802.3af PoE power supply
Dimensions (L x W x H)	96mm*176mm*33mm
Power Supply	DC12V ±25%, IEEE802.3af PoE power supply
Operating Environment	-40°C to 60°C, 10% to 90%, noncondensing, outdoor
Operating System	Linux
Illuminator	IR light (adaptive)

Ordering Info

Product Model	Description
OEU-202S-HMK2	Villa Door Station(IC Card,2 Keypads)

Accessories

EP-SZ202

202 Door Stations Embedded Bracket
(Plastic)



EP-CS202

202 Door Stations Sunshade(Metal)



Dimensions

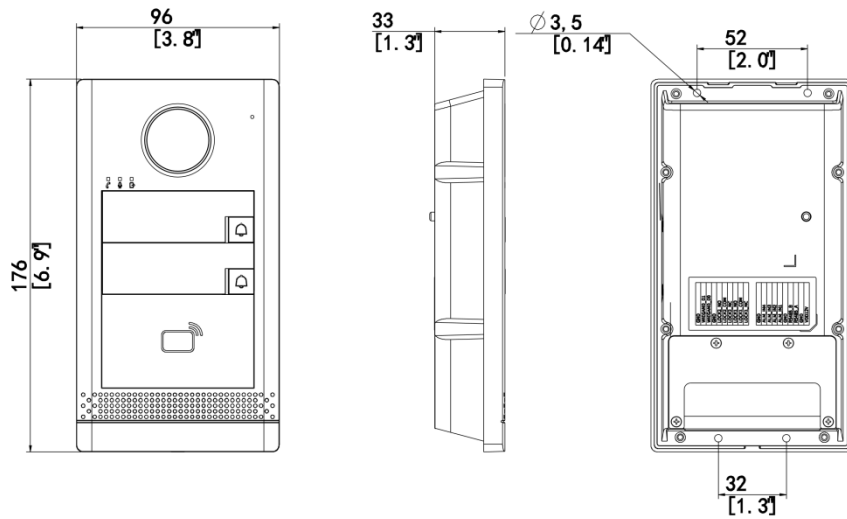

Zhejiang Uniview Technologies Co., Ltd.

No. 369, Xietong Road, Xixing Sub-district, Binjiang District, Hangzhou City, 310051, Zhejiang Province, China (Zhejiang) Pilot Free Trade Zone, China

Email: overseasbusiness@uniview.com; globalsupport@uniview.com

<http://www.uniview.com>

©2024-2025 Zhejiang Uniview Technologies Co., Ltd. All rights reserved.

*Product specifications and availability are subject to change without notice.

*Despite our best efforts, technical or typographical errors may exist in this document. Uniview cannot be held responsible for any such errors and reserves the right to change the contents of this document without prior notice.