

5MP LightHunter HD IR Fixed Mini Bullet Analog Camera UAC-B125-AF28(40)LM

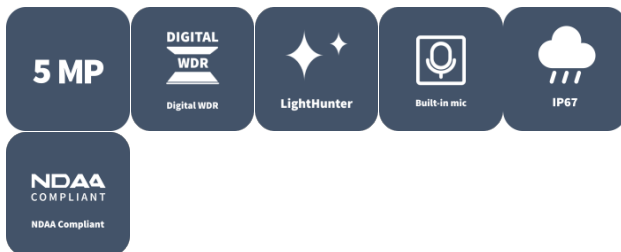

Overview

UAC-B125-AF28(40)LM is a 5MP LightHunter HD IR fixed mini bullet analog camera with a high-performance 1/2.7-inch CMOS sensor. It supports TVI/AHD/CVI/CVBS, which effectively enhances product adaptability and diversity of networking solutions. With SYV-75-3 or other coaxial cable types, the camera can achieve low-cost, long-distance, and anti-interference mega-pixel HD video transmission without time delay. It supports IR-cut filter with auto-switch (ICR) and provides color images at daytime and black/white images at night. The camera also supports audio input and synchronous transmission of audio and video.

Features

- High quality imaging with 5MP resolution
- TVI/AHD/CVI/CVBS
- Supports IR-cut filter with auto-switch (ICR)
- LightHunter monitoring with high-sensitivity sensor
- Supports 180° horizontal flip, 180° vertical flip
- OSD configuration menu, easy to operate
- IP67 waterproof and dustproof design, high reliability
- OSD configuration menu in 11 languages
- Built-in microphone for high quality audio transmission via coaxial cables

Specifications





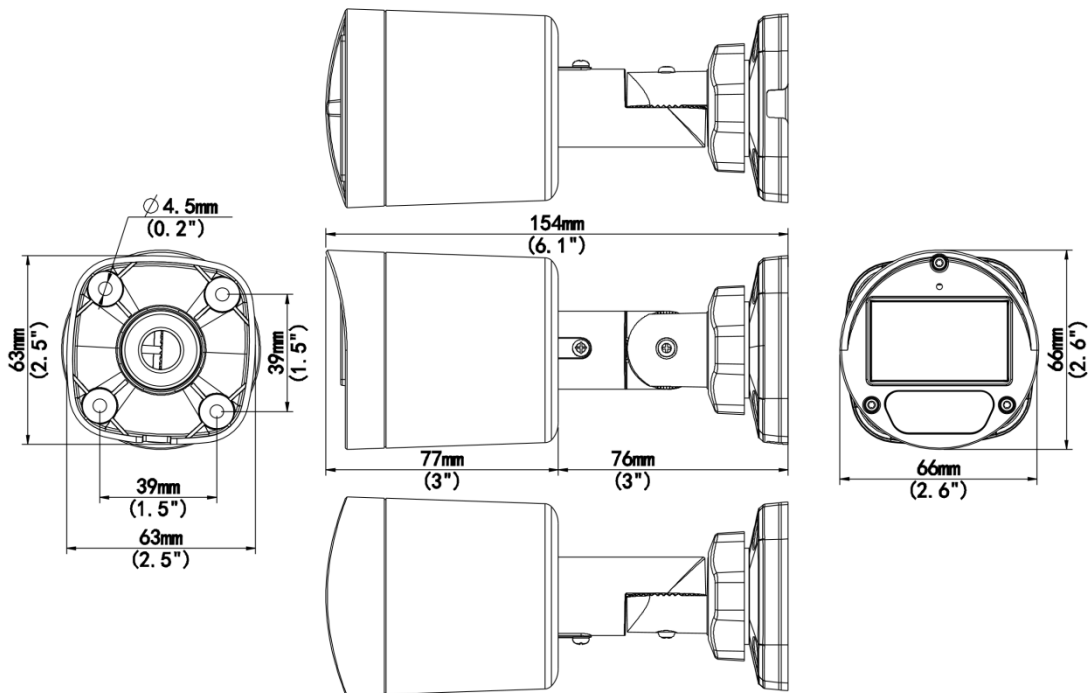

Model	UAC-B125-AF28LM	UAC-B125-AF40LM
Camera		
Max Resolution	5 MP	
Sensor Size	1/2.7" CMOS	
Min. Illumination	0.005 lux (F1.6, AGC ON) 0 lux (IR on)	
Lens		
Focus	2.8 mm	4.0 mm
Lens Mount	M12	
Angle of View (H)	109.1°	91.3°
Angle of View (V)	60.9°	46.1°
Angle of View (D)	126.7°	109.6°
Illuminator		
Illuminator Number	Two IR illuminators	
Illumination Distance	40m	
Lifetime	≥ 60000 hours	
Video		
Resolution	5MP@25fps: 2880(H)×1620(V); 5MP@20fps: 2592(H)×1944(V); 5MP@12.5fps: 2592(H)×1944(V) 4MP: 2560(H)×1440(V) 1080P: 1920(H)×1080(V)	
Frame Rate	TVI: 5MP@20fps (default), 5MP@12.5fps, 4MP@25fps, 4MP@30fps, 1080P@25fps, 1080P@30fps AHD: 5MP@20fps, 4MP@25fps, 4MP@30fps, 1080P@25fps, 1080P@30fps CVI: 5MP@25fps, 4MP@25fps, 4MP@30fps, 1080P@25fps, 1080P@30fps CVBS: PAL, NTSC	
Shutter Time	PAL: 1/25s-1/50000s, NTSC: 1/30s-1/50000s	
Image		
Exposure Mode	Four modes: Global (default), BLC, HLC, DWDR	
Day/Night	Three modes: Auto (default), Day, Night	
Digital Noise Reduction	2D	
White Balance	Two modes: Auto (default), Manual	
WDR	DWDR	
Smart IR	Support	
Flip	Supports 180°horizontal flip, 180°vertical flip	
Digital Defog	N/A	
Audio		
Built-in Mic	Support	
Camera Audio	TVI: 5MP@20fps, 5MP@12.5fps, 4MP@25fps, 4MP@30fps, 1080P@25fps, 1080P@30fps CVI: 5MP@25fps, 4MP@25fps, 4MP@30fps	
Interface		
Power Interface	5.5 mm Power Interface	

Video Output	BNC, supports TVI/AHD/CVI/CVBS
Operating Environment	
Temperature	-30°C to 60°C (-22°F to 140°F)
Humidity	≤ 95% RH (non-condensing)
Surge Protection	4 KV for power, 4 KV for video output interfaces
Ingress Protection	IP67
General	
Power	DC 12 V ± 25%
Power Consumption	MAX 3.4W
Mount	Corner Mount, Pole Mount
Dimensions	154mm*66mm*66mm (L*W*H)
Material	Graphene + Metal + Plastic
Weight	240g(0.53lb)

Dimensions



Accessories

<p>TR-JB05-A-IN Small Bullet Junction Box(Support wiring from behind,Square)</p>	<p>TR-UP06-B-IN Bullet Pole Mounting Bracket</p>	<p>TR-A01-IN NPT 3/4" Waterproof Cable Gland</p>
		
<p>TR-UP06-C-IN-V2 Pole Mounting Bracket for Bullet Junction Box Only</p>	<p>TR-UC08-C-V2 Bullet&Dome Corner Mounting Bracket</p>	<p>PWR-DC1201A-UK DC12V/1A Wall Plug British Standard Power Adapter</p>
		
<p>PWR-DC1201B-UK UNV DC12V/1A Wall Plug British Standard Power Adapter(Colorful Bag)</p>	<p>PWR-DC1201A-US DC12V/1A Wall Plug American Standard Power Adapter</p>	<p>PWR-DC1201B-US UNV DC12V/1A Wall Plug American Standard Power Adapter(Colorful Bag)</p>
		
<p>PWR-DC1201A-EU DC12V/1A Wall Plug European Standard Power Adapter</p>	<p>PWR-DC1201B-EU UNV DC12V/1A Wall Plug European Standard Power Adapter(Colorful Bag)</p>	<p>PWR-DC1201A-IND UNV DC12V/1A Wall Plug Indian Standard Power Adapter-Colorful Bag</p>
		

Unlimited New View

Zhejiang Uniview Technologies Co., Ltd.



<http://www.uniview.com>



overseasbusiness@uniview.com; globalsupport@uniview.com



No. 369, Xietong Road, Xixing Sub-district, Binjiang District, Hangzhou City, 310051, Zhejiang Province, China



©2023-2025 Zhejiang Uniview Technologies Co., Ltd. All rights reserved.

*Product specifications and availability are subject to change without notice.

Despite our best efforts, technical or typographical errors may exist in this document. Uniview cannot be held responsible for any such errors and reserves the right to change the contents of this document without prior notice.