

# 【Datasheet】UNV HC151 ITS 5MP Checkpoint-Capture-Units ( Sky-eye III ) 20231228 (Public)

HC151@GHN-2C32S-OS



## Features

- 5MP industrial camera with wide field of view.
- Excellent performance in low light environments.
- Shipped with an Ethernet extension cable for easy operation.
- Advanced H.265 encoding technology improves compression efficiency.
- Three streams are available for live view and storage to meet different bandwidth and frame rate requirements.
- Violation detection: speeding.
- Vehicle feature recognition: license plate, vehicle color, vehicle type, logo, model, etc.

## Specifications

Model	HC151@GHN-2C32S-OS
Camera	
Sensor	1/1.3" 5MP Global Shutter CMOS
Image settings	Shutter, gain, white balance, WDR
Image/video	

Acquisition format	2560×1920@50fps
Video compression	H.265, H.264, MJPEG
Frame rate	Up to 50fps
Image resolution	2560×1920
Video resolution	Main stream: 2560×1920, 1920×1080, 1600×1200, 1280×720 Sub stream: 1920×1080, 1600×1200, 1280×720, 720×576, 704×288, 352×288 Third stream: 720×576, 704×288, 352×288
Video OSD	Supports various overlays such as date and time with adjustable font size, font style, font color, etc.
Image OSD	Supports various overlays with adjustable overlay position, overlay order, font size, font style, font color, etc.
ROI	Supports up to 8 ROIs
<b>Functions</b>	
Vehicle detection mode	Radar, induction loop, video
Illumination type	Built-in integrated strobe illuminator with adjustable brightness Optional external strobe illuminator or strobe and flash illuminator
Image composition	Support
Image size	Adjustable
Smart-PL	Built-in
<b>Interface</b>	
I/O control	4 × synchronous signal output interface (switch) 8 × synchronous signal output interface (TTL) 8 × signal input interface (switch) Control interface: 4 × RS485, 1 × RS232
Network	2 × RJ45 10M/100M/1000M Base-T adaptive Ethernet interface
Reset button	1
<b>Storage</b>	
Front-end storage	32GB eMMC, supports up to 256G micro SD (TF) card expansion
Automatic Network Replenishment (ANR)	Support
<b>General</b>	
Power supply	AC220V±25%
Power consumption	Camera 12W, heating 12W, fan 1W, built-in LED 10W
Dimensions	530mm×211mm×149mm

Weight	5.96kg
Operating environment	-40°C to 70°C, 10% to 90% RH (non-condensing)
Lightning and surge protection	Support
Ingress protection	IP66
<b>Certification</b>	
EMC	CE LVD : IEC 62368-1:2014
Safety	CE EMC : EN 55032:2015+A11:2020+A1:2020 EN 61000-3-3:2013+A1:2019+A2:2021 EN IEC 61000-3-2:2019+A1:2021 EN 50130-4:2011+A1:2014
<b>LPR</b>	
Vehicle brand detection	Alfa Romeo,Aston Martin,Audi,Bentley,BMW,BYD,Chevrolet, Citroen,Ferrari,Fiat,Ford,Foton,Golden Dragon,Higer,Hino,Honda, Hyundai,Isuzu,Jaguar,Jeep,Kia,Land Rover,Lexus,Maserati,Maxus, Mazda,McLaren,Mercedes-Benz,MG,MINI,Mitsubishi,Nissan,Opel,ORA, Peugeot,Polestar,Porsche,Renault,Rolls-Royce,SEAT,SKODA,Smart, SsangYong,Subaru,Suzuki,Tesla,Toyota,Volkswagen,Volvo,Infinti,BAW,Dodge,Don gFeng,FEIDIE,KingLong,Everus,Chery,SinoTruk,SAAB,Yutong,Proton,Chrysler,Dai hatsu,Datsun,Geely,Hafei,Zotye,Man,Scion,
Supports multiple countries	North America: USA, Canada Northeast Europe: Slovenia, Poland, Czech Republic, Slovakia, Latvia, Belarus, Ukraine, EU: France, Spain, Portugal, Germany, United Kingdom, Ireland, Bulgaria, romania, Hungary, Luxembourg, Serbia, Bosnia and Herzegovina, Greece, Croatia, Middle East: Iraq, Saudi Arabia, UAE (Dubai) Southeast Asia: Singapore, Malaysia, Indonesia, Northeast Asia: South Korea, Africa: Egypt

## Dimensions

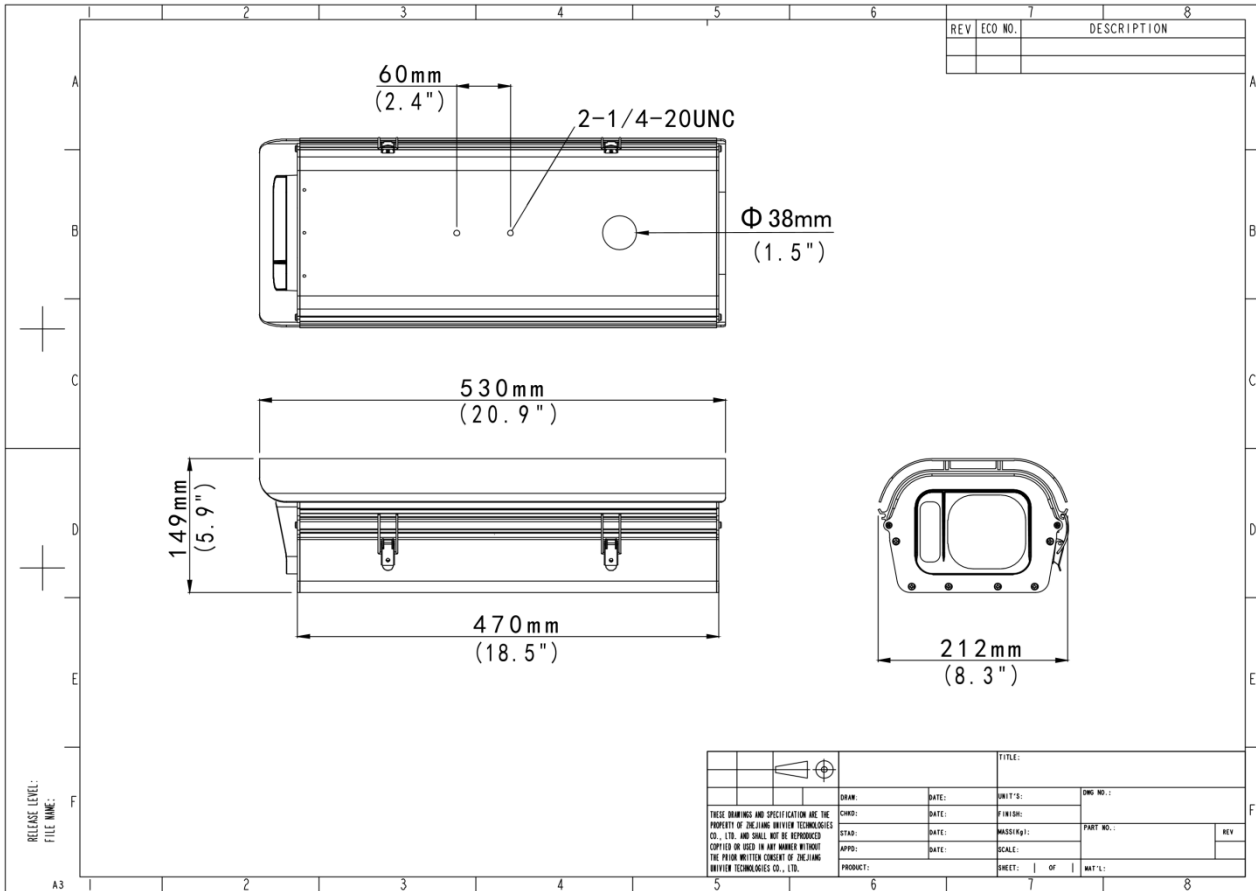

## Ordering Info

Product Model	Config	Description
HC151	GHN-2C32S-OS	5MP Deep Intelligence Checkpoint Camera Unit(Sky-eye)

### Zhejiang Uniview Technologies Co., Ltd.

No. 369, Xietong Road, Xixing Sub-district, Binjiang District, Hangzhou City, 310051, Zhejiang Province, China (Zhejiang) Pilot Free Trade Zone, China

Email: [overseasbusiness@uniview.com](mailto:overseasbusiness@uniview.com); [globalsupport@uniview.com](mailto:globalsupport@uniview.com)

<http://www.uniview.com>

©2023-2025 Zhejiang Uniview Technologies Co., Ltd. All rights reserved.

\*Product specifications and availability are subject to change without notice.

\*Despite our best efforts, technical or typographical errors may exist in this document. Uniview cannot be held responsible for any such errors and reserves the right to change the contents of this document without prior notice.