

## 2MP Wi-Fi IR Dome Camera

### Uho-D1R-M2F3-A



## Features

- High quality image with 2MP, 1/3.0"CMOS sensor
- 2MP (1920 × 1080) @25/20 fps; 720P (1280 × 720) @25/20 fps
- Ultra motion detection (based on human body and vehicle detection)
- Support digital WDR (Wide Dynamic Range)
- Ultra 265, H.265, H.264
- Built in Mic
- Smart IR, up to 30m (98ft) IR distance
- MicroSD, up to 512 GB
- IK10 vandal resistant
- IP67 protection
- 3 Axis

## Specifications

| Model                      | Uho-D1R-M2F3-A  |
|----------------------------|---|
| <b>Camera</b>              |   |
| Max Resolution             | 2 MP  |
| Sensor                     | 1/3.0" CMOS   |
| Min. Illumination          | Colour: 0.01 lux (F2.0 AGC ON)<br>0 lux with IR on  |
| Day/Night                  | IR-cut filter with auto switch (ICR)  |
| Shutter                    | Auto/Manual, 1 to 1/100000 s  |
| Adjustment Angle           | Pan: 0° to 352°, Tilt: 0° to 70°, Rotate: 0° to 350°  |
| S/N                        | > 52 dB   |
| WDR                        | DWDR  |
| <b>Lens</b>                |   |
| Focal Length               | 2.8 mm  |
| Iris Type                  | Fixed   |
| Iris                       | F2.0  |
| Field of View (H)          | 103.0°  |
| Field of View (V)          | 60.7°   |
| Field of View (D)          | 108.4°  |
| <b>DORI</b>                |   |
| DORI Distance (Lens)       | 2.8mm   |
| DORI Distance (Detect)     | 46.7 m (153.1 ft.)  |
| DORI Distance (Observe)    | 18.7 m (61.2 ft.)   |
| DORI Distance (Recognize)  | 9.3 m (30.6 ft.)  |
| DORI Distance (Identify)   | 4.7 m (15.3 ft.)  |
| <b>Illuminator</b>         |   |
| Supplemental Light         | IR  |
| Illumination Distance (IR) | 30 m (98.4 ft.)   |
| Wavelength                 | 850 nm  |
| IR On/Off Control          | Auto/Manual   |
| <b>Video</b>               |   |
| Video Compression          | Ultra 265, H.265, H.264   |
| Frame Rate                 | Main Stream: 1080P (1920 × 1080), Max 25fps; 720P (1280 × 720), Max 25fps<br>Sub Stream: 640 × 360, Max 25fps; 2CIF(704 × 288), Max 25fps; CIF(352 × 288), Max 25fps; |
| Video Bit Rate             | 128 Kbps to 2048 Kbps   |
| U-code                     | Support   |
| OSD                        | Up to 4 OSDs  |
| Privacy Mask               | Support (only NVR)  |
| ROI                        | Support   |
| Video Stream               | Dual streams  |
| <b>Image</b>               |   |

|                         |  |
|-------------------------|--|
| White Balance           | Auto, Outdoor, Fine tune, Sodium lamp, Locked, Auto2   |
| Digital Noise Reduction | 2D/3D DNR  |
| Smart IR                | Support  |
| Flip                    | Normal, Flip vertical, Flip horizontal, 180°   |
| Dewarping               | N/A  |
| HLC                     | N/A  |
| BLC                     | Support  |
| Defog                   | Digital defog  |
| <b>Events</b>           |  |
| Basic Detection         | Ultra motion detection (based on human body and vehicle detection), Tampering alarm, High-Decibel detection                                    |
| General Function        | IP address filtering, Access policy, ARP protection, RTSP authentication, User authentication, HTTP authentication                             |
| <b>Audio</b>            |  |
| Audio Compression       | G.711U, G.711A   |
| Audio Bitrate           | 64 Kbps  |
| Two-way Audio           | N/A  |
| Suppression             | Support  |
| Sampling Rate           | 8 kHz  |
| <b>Storage</b>          |  |
| Edge Storage            | MicroSD, up to 512 GB  |
| Network Storage         | ANR  |
| <b>Network</b>          |  |
| Security                | Password protection, Strong Password, Export operation logs, Basic and Digest Authentication for RTSP, Digest Authentication for HTTP, TLS 1.2 |
| Protocols               | IPv4, TCP, UDP, DHCP, RTSP, DNS, DDNS, NTP, HTTP, ICMP   |
| Compatible Integration  | API, SDK   |
| User/Host               | Up to 6 users. 2 user levels: administrator and common user  |
| Client                  | APP, Uniarch client  |
| Web Browser             | Plug-in required live view: IE 10+, Chrome 45+, Firefox 52+, Edge 79+  |
| <b>Wi-Fi</b>            |  |
| Wireless Standards      | IEEE802.11b/g/n  |
| Frequency Range         | 2.4 GHz to 2.4835 GHz  |
| Channel Bandwidth       | 20 MHz Support   |
| Modulation Mode         | 802.11b: DSSS(CCK, DQPSK, DBPSK) 802.11g/n: OFDM(BPSK, QPSK, QAM16, QAM64)   |
| Wi-Fi Security          | 64/128-bit WEP, WPA-PSK/WPA2-PSK   |
| Transmit Power          | 802.11b: 17±1.5 dBm@11 Mbps802.11g: 14±1.5 dBm@54 Mbps802.11n: 12.5±1.5 dBm@72.2 Mbps  |
| Receive Sensitivity     | 802.11b: -90 dBm@11 Mbps (Typical)802.11g: -75 dBm@54 Mbps (Typical)802.11n: -74 dBm@72.2 Mbps (Typical)                                       |
| Transmission Rate       | 802.11b: 11 Mbps802.11g: 54 Mbps802.11n: up to 72.2 Mbps   |
| <b>Interface</b>        |  |
| Audio I/O               | N/A  |
| Alarm I/O               | N/A  |





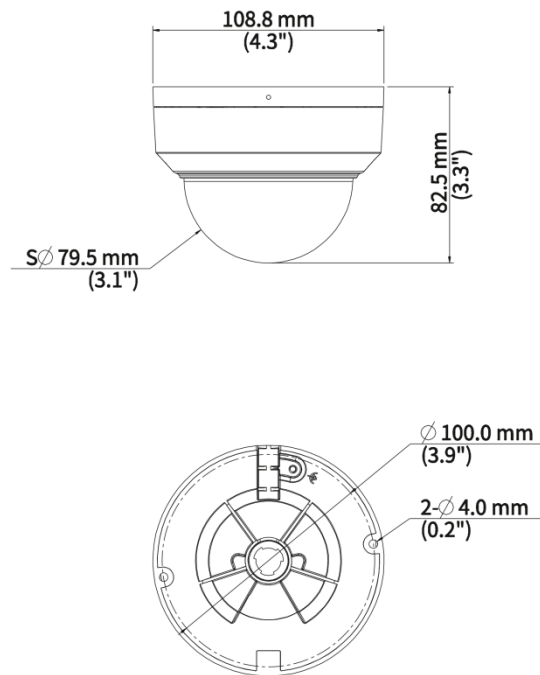





|                      |  |
|----------------------|--|
| Serial Port          | N/A  |
| Built-in Mic         | Support  |
| Built-in Speaker     | N/A  |
| WIFI                 | Support  |
| Network              | 1 × RJ45 10 M/100 M Base-TX Ethernet   |
| Video Output         | N/A  |
| <b>Certification</b> |  |
| EMC                  | CE-EMC (EN 55032, EN 61000-3-3, EN IEC 61000-3-2, EN 50130)<br>FCC (FCC 47 CFR part15 B)   |
| RF                   | FCC ID (FCC CFR 47 part15 C)CE RED (EN 301 489-1, EN 301 489-17, EN 300 328, EN IEC 62311) |
| Safety               | CE LVD (EN 62368-1)  |
| Environment          | CE-RoHS (2011/65/EU;(EU)2015/863); WEEE (2012/19/EU);                                      |
| Protection           | IP67 (IEC 60529)<br>IK10 (IEC 62262)   |
| <b>General</b>       |  |
| Power                | DC 12 V±25%  |
| Power Consumption    | Max 2.2 W  |
| Power Interface      | Ø5.5 mm coaxial power plug   |
| Dimensions           | Ø109 mm × 83 mm (Ø4.3" × 3.3") (Ø × H)   |
| Weight               | 0.33kg (0.73 lb)   |
| Material             | Metal + Plastic  |
| Storage Environment  | -30 °C to 60 °C (-22 °F to 140 °F), Humidity: ≤ 95% RH (non-condensing)                    |
| Working Environment  | -30 °C to 60 °C (-22 °F to 140 °F), Humidity: ≤ 95% RH (non-condensing)                    |
| Surge Protection     | 4 KV   |
| Reset Button         | Support  |
| RTC                  | Support  |
| Web Client Language  | 1 Language: English  |

## Dimensions



## Accessories

| <b>TR-JB03-G-IN</b><br>Junction Box for Mini Fix-dome(Support wiring from behind)   | <b>HS-205S</b><br>Sunshade Shell for Fixed Focus Dome                               | <b>TR-JB07/WM03-G-IN-V2</b><br>Wall Mounting Assembling Bracket For 32 Fix-dome&Mini Fix-dome&Plastic Turret Camera |
|---|---|---|
|  |  |                                |

|   |  |  |
|---|--|--|
| <p><b>TR-WM03-D-IN-V2</b><br/>Wall Mounting Bracket for 32<br/>Fix-dome&amp;Mini Fix-dome&amp;Plastic Turret<br/>Camera</p> | <p><b>TR-UM06-E-IN</b><br/>Slant Mounting Bracket for Fixed Dome</p>               | <p><b>TR-A01-IN</b><br/>NPT 3/4" Waterproof Cable Gland</p>                          |
|    |   |   |
| <p><b>TR-UP06-C-IN-V2</b><br/>Pole Mounting Bracket for Bullet Junction<br/>Box Only</p>                                    | <p><b>TR-UC08-C-V2</b><br/>Bullet&amp;Dome Corner Mounting Bracket</p>             | <p><b>TR-SE24-IN</b><br/>Dome Pendant Mounting Pole 200mm</p>                        |
|    |   |   |
| <p><b>TR-SE24-A-IN</b><br/>Dome Pendant Mounting Pole 500mm</p>   | <p><b>TR-CM24-IN</b><br/>Dome Pendant Mounting Bracket(Indoor)</p>                 | <p><b>TR-WM07P-B</b><br/>Dome Wall Mounting Plastic Bracket</p>                      |
|   |  |  |
| <p><b>TR-FM116</b><br/>In-ceiling Bracket for Fix-dome</p>  |  |  |
|    |  |  |

**Zhejiang Uniview Technologies Co., Ltd.**

-  <http://www.uniview.com>
-  [overseasbusiness@uniview.com](mailto:overseasbusiness@uniview.com); [globalsupport@uniview.com](mailto:globalsupport@uniview.com)
-  No. 369, Xietong Road, Xixing Sub-district, Binjiang District, Hangzhou City, 310051, Zhejiang Province, China



©2023-2025 Zhejiang Uniview Technologies Co., Ltd. All rights reserved.

\*Product specifications and availability are subject to change without notice.

\*Despite our best efforts, technical or typographical errors may exist in this document.

Uniview cannot be held responsible for any such errors and reserves the right to change the contents of this document without prior notice.