

2MP Wi-Fi IR Dome Camera

Uho-D1R-M2F3-A



Features

- High quality image with 2MP, 1/3.0"CMOS sensor
- 2MP (1920 × 1080) @25/20 fps; 720P (1280 × 720) @25/20 fps
- Ultra motion detection (based on human body and vehicle detection)
- Support digital WDR (Wide Dynamic Range)
- Ultra 265, H.265, H.264
- Built in Mic
- Smart IR, up to 30m (98ft) IR distance
- MicroSD, up to 512 GB
- IK10 vandal resistant
- IP67 protection
- 3 Axis

Specifications

Model	Uho-D1R-M2F3-A
Camera	
Max Resolution	2 MP
Sensor	1/3.0" CMOS
Min. Illumination	Colour: 0.01 lux (F2.0 AGC ON) 0 lux with IR on
Day/Night	IR-cut filter with auto switch (ICR)
Shutter	Auto/Manual, 1 to 1/100000 s
Adjustment Angle	Pan: 0° to 352°, Tilt: 0° to 70°, Rotate: 0° to 350°
S/N	> 52 dB
WDR	DWDR
Lens	
Focal Length	2.8 mm
Iris Type	Fixed
Iris	F2.0
Field of View (H)	103.0°
Field of View (V)	60.7°
Field of View (D)	108.4°
DORI	
DORI Distance (Lens)	2.8mm
DORI Distance (Detect)	46.7 m (153.1 ft.)
DORI Distance (Observe)	18.7 m (61.2 ft.)
DORI Distance (Recognize)	9.3 m (30.6 ft.)
DORI Distance (Identify)	4.7 m (15.3 ft.)
Illuminator	
Supplemental Light	IR
Illumination Distance (IR)	30 m (98.4 ft.)
Wavelength	850 nm
IR On/Off Control	Auto/Manual
Video	
Video Compression	Ultra 265, H.265, H.264
Frame Rate	Main Stream: 1080P (1920 × 1080), Max 25fps; 720P (1280 × 720), Max 25fps Sub Stream: 640 × 360, Max 25fps; 2CIF(704 × 288), Max 25fps; CIF(352 × 288), Max 25fps;
Video Bit Rate	128 Kbps to 2048 Kbps
U-code	Support
OSD	Up to 4 OSDs
Privacy Mask	Support (only NVR)
ROI	Support
Video Stream	Dual streams
Image	

White Balance	Auto, Outdoor, Fine tune, Sodium lamp, Locked, Auto2
Digital Noise Reduction	2D/3D DNR
Smart IR	Support
Flip	Normal, Flip vertical, Flip horizontal, 180°
Dewarping	N/A
HLC	N/A
BLC	Support
Defog	Digital defog
Events	
Basic Detection	Ultra motion detection (based on human body and vehicle detection), Tampering alarm, High-Decibel detection
General Function	IP address filtering, Access policy, ARP protection, RTSP authentication, User authentication, HTTP authentication
Audio	
Audio Compression	G.711U, G.711A
Audio Bitrate	64 Kbps
Two-way Audio	N/A
Suppression	Support
Sampling Rate	8 kHz
Storage	
Edge Storage	MicroSD, up to 512 GB
Network Storage	ANR
Network	
Security	Password protection, Strong Password, Export operation logs, Basic and Digest Authentication for RTSP, Digest Authentication for HTTP, TLS 1.2
Protocols	IPv4, TCP, UDP, DHCP, RTSP, DNS, DDNS, NTP, HTTP, ICMP
Compatible Integration	API, SDK
User/Host	Up to 6 users. 2 user levels: administrator and common user
Client	APP, Uniarch client
Web Browser	Plug-in required live view: IE 10+, Chrome 45+, Firefox 52+, Edge 79+
Wi-Fi	
Wireless Standards	IEEE802.11b/g/n
Frequency Range	2.4 GHz to 2.4835 GHz
Channel Bandwidth	20 MHz Support
Modulation Mode	802.11b: DSSS(CCK, DQPSK, DBPSK) 802.11g/n: OFDM(BPSK, QPSK, QAM16, QAM64)
Wi-Fi Security	64/128-bit WEP, WPA-PSK/WPA2-PSK
Transmit Power	802.11b: 17±1.5 dBm@11 Mbps802.11g: 14±1.5 dBm@54 Mbps802.11n: 12.5±1.5 dBm@72.2 Mbps
Receive Sensitivity	802.11b: -90 dBm@11 Mbps (Typical)802.11g: -75 dBm@54 Mbps (Typical)802.11n: -74 dBm@72.2 Mbps (Typical)
Transmission Rate	802.11b: 11 Mbps802.11g: 54 Mbps802.11n: up to 72.2 Mbps
Interface	
Audio I/O	N/A
Alarm I/O	N/A





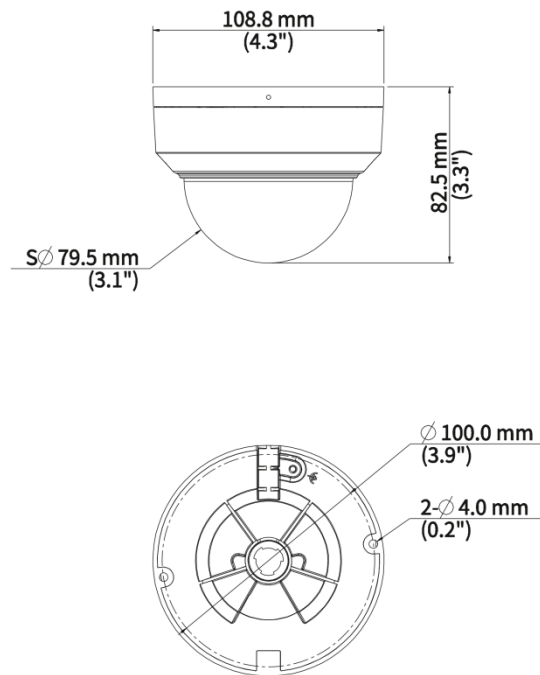





Serial Port	N/A
Built-in Mic	Support
Built-in Speaker	N/A
WIFI	Support
Network	1 × RJ45 10 M/100 M Base-TX Ethernet
Video Output	N/A
Certification	
EMC	CE-EMC (EN 55032, EN 61000-3-3, EN IEC 61000-3-2, EN 50130) FCC (FCC 47 CFR part15 B)
RF	FCC ID (FCC CFR 47 part15 C)CE RED (EN 301 489-1, EN 301 489-17, EN 300 328, EN IEC 62311)
Safety	CE LVD (EN 62368-1)
Environment	CE-RoHS (2011/65/EU;(EU)2015/863); WEEE (2012/19/EU);
Protection	IP67 (IEC 60529) IK10 (IEC 62262)
General	
Power	DC 12 V±25%
Power Consumption	Max 2.2 W
Power Interface	Ø5.5 mm coaxial power plug
Dimensions	Ø109 mm × 83 mm (Ø4.3" × 3.3") (Ø × H)
Weight	0.33kg (0.73 lb)
Material	Metal + Plastic
Storage Environment	-30 °C to 60 °C (-22 °F to 140 °F), Humidity: ≤ 95% RH (non-condensing)
Working Environment	-30 °C to 60 °C (-22 °F to 140 °F), Humidity: ≤ 95% RH (non-condensing)
Surge Protection	4 KV
Reset Button	Support
RTC	Support
Web Client Language	1 Language: English

Dimensions



Accessories

TR-JB03-G-IN Junction Box for Mini Fix-dome(Support wiring from behind)	HS-205S Sunshade Shell for Fixed Focus Dome	TR-JB07/WM03-G-IN-V2 Wall Mounting Assembling Bracket For 32 Fix-dome&Mini Fix-dome&Plastic Turret Camera
		

<p>TR-WM03-D-IN-V2 Wall Mounting Bracket for 32 Fix-dome&Mini Fix-dome&Plastic Turret Camera</p>	<p>TR-UM06-E-IN Slant Mounting Bracket for Fixed Dome</p>	<p>TR-A01-IN NPT 3/4" Waterproof Cable Gland</p>
		
<p>TR-UP06-C-IN-V2 Pole Mounting Bracket for Bullet Junction Box Only</p>	<p>TR-UC08-C-V2 Bullet&Dome Corner Mounting Bracket</p>	<p>TR-SE24-IN Dome Pendant Mounting Pole 200mm</p>
		
<p>TR-SE24-A-IN Dome Pendant Mounting Pole 500mm</p>	<p>TR-CM24-IN Dome Pendant Mounting Bracket(Indoor)</p>	<p>TR-WM07P-B Dome Wall Mounting Plastic Bracket</p>
		
<p>TR-FM116 In-ceiling Bracket for Fix-dome</p>		
		

Zhejiang Uniview Technologies Co., Ltd.



<http://www.uniview.com>



overseasbusiness@uniview.com; globalsupport@uniview.com



No. 369, Xietong Road, Xixing Sub-district, Binjiang District, Hangzhou City, 310051, Zhejiang Province, China



©2023-2025 Zhejiang Uniview Technologies Co., Ltd. All rights reserved.

*Product specifications and availability are subject to change without notice.

*Despite our best efforts, technical or typographical errors may exist in this document.

Uniview cannot be held responsible for any such errors and reserves the right to change the contents of this document without prior notice.