

4MP 16X LightHunter Network PTZ Dome Camera Datasheet

IPC6434LR-X16-VG1



Features

- High quality image with 4 MP, 1/2.9" CMOS sensor
- 2688 × 1520@30 fps in the main stream
- Ultra 265, H.265, H.264, MJPEG
- Dual streams
- 16X optical zoom
- LightHunter technology ensures ultra-high image quality in low illumination environment
- Smart IR, up to 100 m (328 ft.) IR distance
- DC 12 V±10%, PoE+ (IEEE 802.3at)
- Alarm I/O: 2/1, audio I/O: 1/1
- IP66 ingress protection
- IK10 vandal resistant

Specifications

Model	IPC6434LR-X16-VG1
Camera	
Max Resolution	4 MP
Sensor	1/2.9" CMOS
Min. Illumination	Color: 0.005 Lux (F1.78, AGC ON), 0 Lux with IR
Day/Night	IR-cut filter with auto switch (ICR)
Shutter	Auto/Manual, 1 ~ 1/100000s
WDR	120 dB
S/N	>56 dB
Lens	
Focal Length	5.5 to 88 mm
Optical Zoom	16X
Iris	F1.78-F3.73
Field of View (H)	50.85° to 3.47°
Field of View (V)	29.94° to 1.95°
Field of View (D)	62.55° to 4.09°
DORI	
DORI Distance (Detect)	127.6 m to 2048.4 m (418.6 ft. to 6720.5 ft.)
DORI Distance (Observe)	51.0 m to 819.4 m (167.4 ft. to 2688.2 ft.)
DORI Distance (Recognize)	25.5 m to 409.7 m (83.7 ft. to 1344.1 ft.)
DORI Distance (Identify)	12.8 m to 204.8 m (41.9 ft. to 672.0 ft.)
Video	
Privacy Mask	24 areas, up to 4 areas per scene
Video Compression	Ultra 265, H.265, H.264, MJPEG
Frame Rate	Main Stream: 4 MP (2688 × 1520), max. 30 fps Sub Stream: 720P (1280 × 720), max. 30 fps
Video Bit Rate	128 Kbps to 16 Mbps
U-code	Support
ROI	Support
Video Stream	Dual streams
OSD	Up to 4 OSDs
Intelligent	
Auto Tracking	Support, target filtering: human and vehicle
Smart Intrusion Prevention	Cross line detection, intrusion detection (support false alarm filtering and the classification of human and vehicle)
Image	
White Balance	Auto, Outdoor, Fine tune, Sodium lamp, Locked, Auto2
Digital Noise Reduction	2D/3D DNR
Flip	Normal, Flip vertical, Flip horizontal, 180°
HLC	Support
BLC	Support





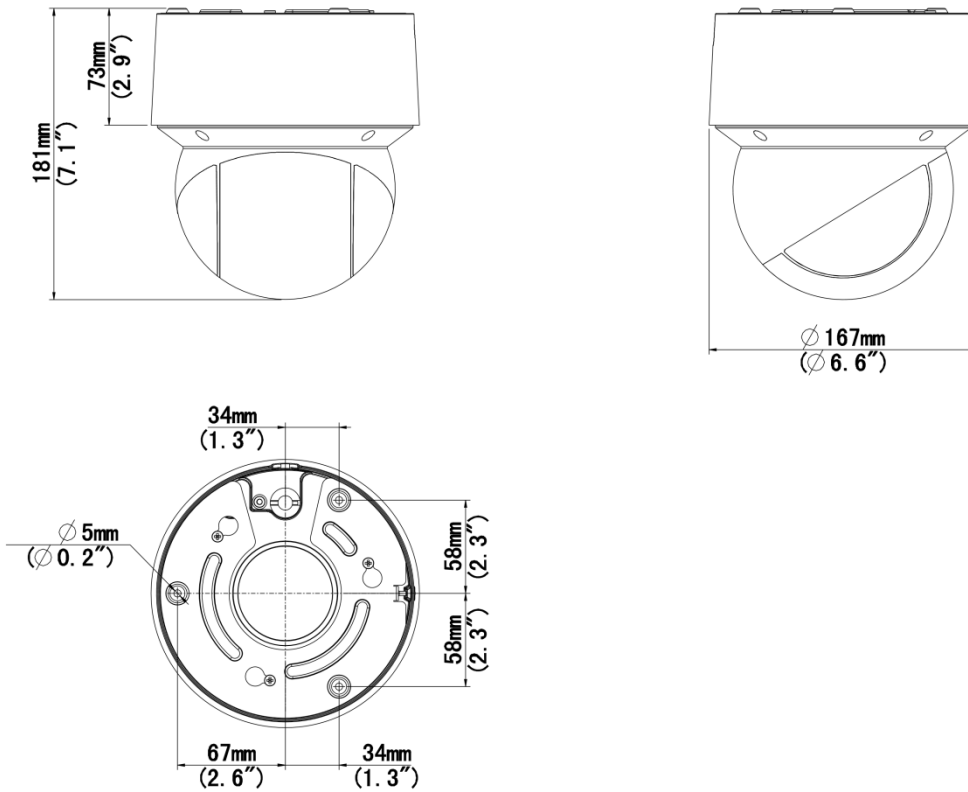

Smart IR	Support
Defog	Digital defog
Events	
Basic Detection	Motion detection, Tampering alarm, Audio detection
General Function	Watermark, IP address filtering, Access policy, ARP protection, RTSP authentication, User authentication, Alarm input
Audio	
Audio Compression	G.711U, G.711A
Audio Bitrate	128 Kbps
Two-way Audio	Support
Suppression	Support
Sampling Rate	16KHZ
Storage	
Edge Storage	MicroSD, up to 512 GB
Network Storage	ANR, NAS (NFS)
Illuminator	
IR On/Off Control	Auto/Manual
Wavelength	850 nm
Illumination Distance (IR)	Up to 100m (328 ft) IR range
Network	
Protocols	IPv4, IPv6, IGMP, RTP, ICMP, ARP, TCP, UDP, DHCP, PPPoE, RTSP, RTCP, RTMP, DNS, DDNS, NTP, FTP, UPnP, HTTP, HTTPS, 802.1x, SNMP, QoS, SSL/TLS
Compatible Integration	ONVIF (Profile S, Profile G, Profile T, Profile M), SDK, API
User/Host	Up to 32 users. 3 user levels: administrator, common user and operator
Security	Password Protection, Strong Password, HTTPS Encryption, Export Operation Logs, Basic and Digest Authentication for RTSP, Digest Authentication for HTTP, TLS 1.2, WSSE and Digest Authentication for ONVIF
Client	EZStation, UNV-Link, UNV-Link Pro
Web Browser	Plug-in required live view: IE 10+, Chrome 45+, Firefox 52+, Edge 79+
PTZ	
Number of Presets	1024
Preset Patrol	16 patrols, up to 64 presets for each patrol
Route Patrol	16 patrols, up to 32 actions for each patrol
Recorded Patrol	16 patrols, up to 128 actions for each patrol
Patrol Stay Time	15 s to 1800 s
Home Position	Support
Pan Range	360° (endless)
Tilt Range	-5° to 90° (auto flip)
Pan Speed	0.1°/s to 240°/s
Tilt Speed	0.1°/s to 120°/s
Interface	
Audio I/O	1 Input: impedance 1 k Ω , amplitude 2.5 V [p-p], 1 Output: impedance 600 Ω , amplitude 2.5 V [p-p]
Alarm I/O	2/1







Serial Port	1*RS485
Network	1 × RJ45 10 M/100 M Base-TX Ethernet
Certification	
EMC	CE-EMC (EN 55032: 2015+A11:2020+A1: 2020,EN IEC 61000-3-2: 2019+A1: 2021,EN 61000-3-3: 2013+A1: 2019+A2:2021,EN 50130-4: 2011+A1:2014) FCC (FCC CFR 47 part15 B, ANSI C63.4-2014)
Safety	CE LVD (EN 62368-1:2014+A11:2017) UL (UL 62368-1, 2nd Ed., Issue Date: 2014-12-01)
Environment	CE-ROHS (2011/65/EU;(EU)2015/863)
Protection	IP66 (IEC 60529:1989+AMD1:1999+AMD2:2013) IK10 (IEC 62262:2002)
General	
Power	DC 12 V (±10%, 3A), PoE+ (IEEE 802.3at)
Power Consumption	Max. 23 W
Power Interface	Ø5.5 mm coaxial power plug
Dimensions	Ø167 mm × 181 mm (Ø6.6" × 7.1") (Ø × H)
Weight	2.3 kg (5.07 lb.)
Working Environment	-40°C~65°C (-40°F~149°F), Humidity: ≤95% RH (non-condensing)
Storage Environment	-40°C~70°C (-40°F~158°F), Humidity: ≤95% RH (non-condensing)
Surge Protection	6 KV
Reset Button	Support
Configurable	
P/N	Support

Dimensions



Accessories

TR-FM180-IN In-ceiling Bracket for Cover Dome	TR-CE45-IN Dome Indoor Ceiling Mounting Bracket	TR-SE45-IN Dome Ceiling Mounting Pole 200
		
TR-SE45-A-IN Dome Ceiling Mounting Pole 500	TR-UF45-L-IN Cover Dome Adapter	TR-WE45-IN Dome Wall Mounting Bracket
		

<p>TR-WE45-B-IN Dome Gooseneck Bracket</p>	<p>TR-JB12-IN Dome Junction Box</p>	<p>TR-UP08-B-IN Aluminium Alloy Pole Mounting Bracket</p>
		
<p>TR-UC08-B-IN Aluminium Alloy Corner Mounting Bracket</p>	<p>TR-JB04-E-IN Cover Dome Junction Box</p>	<p>TR-UP04-IN Mounting Bracket</p>
		

Unlimited New View

Zhejiang Uniview Technologies Co., Ltd.



<http://www.uniview.com>



overseasbusiness@uniview.com; globalsupport@uniview.com



No. 369, Xietong Road, Xixing Sub-district, Binjiang District, Hangzhou City, 310051, Zhejiang Province, China



©2023-2025 Zhejiang Uniview Technologies Co., Ltd. All rights reserved.

*Product specifications and availability are subject to change without notice.

Despite our best efforts, technical or typographical errors may exist in this document. Uniview cannot be held responsible for any such errors and reserves the right to change the contents of this document without prior notice.