

Network Box Cameras

Quick Guide

V3.00

Preface

The content of this section is designed to ensure that users use the product correctly to prevent dangers or property loss caused by improper operation. Before using this product, be sure to read this manual carefully. Please keep this manual properly for future reference.

About This Manual

- We recommend that you use this manual under the guidance of a professional.
- This manual is designed for use with multiple product models, and it is not possible to list the appearance and functions of each product individually. Please refer to the actual product for use.
- This manual is intended for multiple software versions, and the illustrations and descriptions in this manual may be different from the actual GUI and functions of the software.
- Despite our best efforts, technical or typographical errors may exist in this manual. Uniview cannot be held responsible for any such errors and reserves the right to change the manual without prior notice.
- Users are fully responsible for the damages and losses that arise due to improper operation.
- Uniview reserves the right to change any information in this manual without any prior notice or indication. Due to such reasons as product version upgrade or regulatory requirement of relevant regions, this manual will be periodically updated.
- This manual will be updated in real time according to the laws and regulations of the relevant regions. For specific details, please refer to the product's paper copy, QR code, or official website. In case of any discrepancy between the paper copy and the electronic version, the electronic version shall prevail.

About This Product

If the product you have chosen is a video product, please strictly adhere to the applicable laws and regulations. You can visit our official website to inquire about the relevant content.

Instructions for Use

- This document serves as a guide for use only. All statements, information, and suggestions contained in this document do not constitute any express or implied warranty.
- We assume no responsibility for any special, incidental, consequential, or indirect damages resulting from the use of this manual or the use of our products, including but not limited to losses due to loss of business profits, data or document loss, and product malfunction or information leakage caused by cyber-attack, hacker attack, and virus infections.
- Due to uncertain factors such as the physical environment, there may be discrepancies between the actual values of some data and the reference values provided in the manual. In case of any questions or disputes, the company's final interpretation shall prevail.



Formatting Conventions

The UI formatting conventions used in this document are as follows:

Format	Meaning
Bold	Bold means UI elements (button names, menu names, window names, etc.), e.g., Click Save .
>	Indicate a sequence of actions, e.g., click Device Management > Add Device, which means first click Device Management, and then click Add Device.

Symbol Conventions

This document uses various distinctive symbols to highlight areas that require special attention during the operation process. The meanings of these symbols are as follows:

Symbol	Meaning
	NOTE: Provides tips and additional information related to the operation and use of the product.
	CAUTION: Alerts to matters that requires attention during operation, as improper handling may lead to product damage, data loss, or functional abnormalities.
	WARNING: The annotations following this symbol demand extra attention, as improper handling could potentially cause personal injury.

Legal Statement

Copyright Statement

©2021-2025 Zhejiang Uniview Technologies., Co., Ltd. All rights reserved.

All parts of this document, including but not limited to text, images, and graphics, are copyrighted and belong to Zhejiang Uniview Technologies Co., Ltd (hereinafter referred to as "Uniview" "we" "us"). Without our written permission, no organization or individual may excerpt, copy, translate, modify, or disseminate any part or all of the content of this manual in any form.

The products described in this manual may contain software copyrighted by us and any potential licensors. Without the permission of the relevant rights holders, no one may copy, distribute, modify, excerpt, decompile, disassemble, decrypt, reverse engineer, rent, transfer, sublicense, or engage in any other actions that infringe upon the software copyright in any form.

Trademark Acknowledgements

 are trademarks or registered trademarks of Uniview.

All other trademarks, products, services and companies in this manual or the product described in this manual are the property of their respective owners.

Export Compliance Statement

Uniview complies with applicable export control laws and regulations worldwide, including that of the People's Republic of China and the United States, and abides by relevant regulations relating to the export, re-export and transfer of hardware, software and technology. Regarding the product described in this manual, Uniview asks you to fully understand and strictly abide by the applicable export laws and regulations worldwide.

EU Authorised Representative

UNV Technology EUROPE B.V. Treubstraat 1, 2288 EG, Rijswijk, Netherlands.

If you have any feedback, please contact us at service@uniview.com.

Disclaimer of Liability

- We assume no responsibility and offer no compensation for any special, incidental, consequential, or indirect damages resulting from the use of this manual or our products, including but not limited to losses related to lost business profits, data, or document loss.
- The product described in this manual is provided on an "as is" basis. Unless required by applicable law, this manual is only for informational purpose, and all statements, information, and recommendations in this manual are presented without warranty of any kind, expressed or implied, including, but not limited to, merchantability, satisfaction with quality, fitness for a particular purpose, and noninfringement.
- Users must assume total responsibility and all risks for connecting the product to the Internet, including, but not limited to, network attack, hacking, and virus. Uniview strongly recommends that

users take all necessary measures to enhance the protection of network, device, data and personal information. Uniview disclaims any liability related thereto but will readily provide necessary security related support.

- To the extent not prohibited by applicable law, in no event will Uniview and its employees, licensors, subsidiary, affiliates be liable for results arising out of using or inability to use the product or service, including, not limited to, loss of profits and any other commercial damages or losses, loss of data, procurement of substitute goods or services; property damage, personal injury, business interruption, loss of business information, or any special, direct, indirect, incidental, consequential, pecuniary, coverage, exemplary, subsidiary losses, however caused and on any theory of liability, whether in contract, strict liability or tort (including negligence or otherwise) in any way out of the use of the product, even if Uniview has been advised of the possibility of such damages (other than as may be required by applicable law in cases involving personal injury, incidental or subsidiary damage).
- To the extent allowed by applicable law, in no event shall Uniview's total liability to you for all damages for the product described in this manual (other than as may be required by applicable law in cases involving personal injury) exceed the amount of money that you have paid for the product.
- When using this product, please strictly adhere to the applicable laws and regulations to avoid infringing upon the rights of third parties, including but not limited to intellectual property rights, data rights, or other privacy rights. You must also not use this product for the purposes of developing or facilitating the use of weapons of mass destruction, biological or chemical weapons, nuclear weapons, or for any other purposes that violate international norms and regulations.

Privacy Protection Reminder

Uniview complies with appropriate privacy protection laws and is committed to protecting user privacy. You may want to read our full privacy policy at our website and get to know the ways we process your personal information. Please be aware, using the product described in this manual may involve the collection of personal information such as face, fingerprint, license plate number, email, phone number, GPS. Please abide by your local laws and regulations while using the product.

Safety Precautions

The device must be installed, serviced and maintained by a trained professional with necessary safety knowledge and skills. Before you start using the device, please read through this guide carefully and make sure all applicable requirements are met to avoid danger and loss of property.

Storage, Transportation, and Use

- Store or use the device in a proper environment that meets environmental requirements, including and not limited to, temperature, humidity, dust, corrosive gases, electromagnetic radiation, etc.
- Make sure the device is securely installed or placed on a flat surface to prevent falling.
- Unless otherwise specified, do not stack devices.
- Ensure good ventilation in the operating environment. Do not cover the vents on the device. Allow adequate space for ventilation.
- Protect the device from liquid of any kind.
- Make sure the power supply provides a stable voltage that meets the power requirements of the device. Make sure the power supply's output power exceeds the total maximum power of all the connected devices.
- Verify that the device is properly installed before connecting it to power.
- Do not remove the seal from the device body without consulting Uniview first. Do not attempt to service the product yourself. Contact a trained professional for maintenance.
- Always disconnect the device from power before attempting to move the device.
- Take proper waterproof measures in accordance with requirements before using the device outdoors.

Power Requirements

- Install and use the device in strict accordance with your local electrical safety regulations.

- Use a UL certified power supply that meets LPS requirements if an adapter is used.
- Use the recommended cordset (power cord) in accordance with the specified ratings.
- Only use the power adapter supplied with your device.
- Use a mains socket outlet with a protective earthing (grounding) connection.
- Ground your device properly if the device is intended to be grounded.

Battery Safety

Please use batteries properly; otherwise, there is a risk of fire or explosion.

- **Warning:** Using incorrect battery models can lead to explosion.
- If you need to replace the battery, it is recommended that you go to an authorized service center or have it replaced under professional supervision. We shall not be held responsible for any issues arising from unauthorized battery replacement.
- When replacing the battery, be sure to use a battery of the same type as the original! Using the wrong model for replacement (such as certain types of lithium batteries) may cause safety protection to fail.
- Batteries must not be exposed to overheat environments such as sunlight, fire, as this may lead to fire, explosion, or combustion.
- Do not dispose of batteries in fire or heating appliances. Do not squeeze, bend, or cut batteries, as it may cause explosion.
- Do not expose batteries to extremely high or low temperatures, or to very low-pressure environments, as this may cause explosion or leakage of flammable liquid/gas.
- Dispose of the used battery according to your local regulations or the battery manufacturer's instructions.
- For products or the included remote control containing a button cell battery: Do not ingest the battery - chemical burn hazard! If swallowed, a button cell battery can cause severe internal burns within 2 hours and may be fatal. Precautions (including but not limited to):
 - Keep new and used batteries away from children.
 - Stop using the product and keep it away from children if the battery compartment is not securely closed.
 - If you suspect that a battery may have been swallowed or inserted inside any part of the body, seek immediate medical attention.

Network Security

Please take all necessary measures to enhance network security for your device.

The following are necessary measures for the network security of your device:

- **Change default password and set strong password:** You are strongly recommended to change the default password after your first login and set a strong password of at least nine characters including all three elements: digits, letters and special characters.
 - Do not include the account name or the reverse of the account name.
 - Avoid using consecutive characters, such as 123, abc, etc.
 - Do not use overlapping characters, such as 111, aaa, etc.
- **Keep firmware up to date:** It is recommended that your device is always upgraded to the latest version for the latest functions and better security. Visit Uniview's official website or contact your local dealer for the latest firmware.

The following are recommendations for enhancing network security of your device:

- **Change password regularly:** Change your device password on a regular basis and keep the password safe. Make sure only the authorized user can log in to the device.
- **Enable HTTPS/SSL:** Use SSL certificate to encrypt HTTP communications and ensure data security.
- **Enable IP address filtering:** Allow access only from the specified IP addresses.
- **Minimum port mapping:** Configure your router or firewall to open a minimum set of ports to the WAN and keep only the necessary port mappings. Never set the device as the DMZ host or configure a full cone NAT.
- **Disable the automatic login and save password features:** If multiple users have access to your computer, it is recommended that you disable these features to prevent unauthorized access.

- **Choose username and password discretely:** Avoid using the username and password of your social media, bank, email account, etc., as the username and password of your device, in case your social media, bank and email account information is leaked.
- **Restrict user permissions:** If more than one user needs access to your system, make sure each user is granted only the necessary permissions.
- **Disable UPnP:** When UPnP is enabled, the router will automatically map internal ports, and the system will automatically forward port data, which results in the risks of data leakage. Therefore, it is recommended to disable UPnP if HTTP and TCP port mapping have been enabled manually on your router.
- **Multicast:** Multicast is intended to transmit video to multiple devices. If you do not use this function, it is recommended you disable multicast on your network.
- **Check logs:** Check your device logs regularly to detect unauthorized access or abnormal operations.
- **Isolate video surveillance network:** Isolating your video surveillance network with other service networks helps prevent unauthorized access to devices in your security system from other service networks.
- **Physical protection:** Keep the device in a locked room or cabinet to prevent unauthorized physical access.
- **SNMP:** Disable SNMP if you do not use it. If you do use it, then SNMPv3 is recommended.

Learn More

You may also obtain security information under Security Response Center at Uniview's official website.

Avertissement de l'utilisation de la batterie

- Lorsque utiliser la batterie, évitez:
 - Température et pression d'air extrêmement élevées ou basses pendant l'utilisation, le stockage et le transport.
 - Remplacement de la batterie.
- Utilisez la batterie correctement. Mauvaise utilisation de la batterie comme celles mentionnées ici, peut entraîner des risques d'incendie, d'explosion ou de fuite liquide de gaz inflammables.
 - Remplacer la batterie par un type incorrect;
 - Disposer d'une batterie dans le feu ou un four chaud, écraser mécaniquement ou couper la batterie;
- Disposer la batterie utilisée conformément à vos règlements locaux ou aux instructions du fabricant de la batterie.

Regulatory Compliance

FCC Statements

This device complies with Part 15 of the FCC Rules. Operation is subject to the following two conditions: (1) this device may not cause harmful interference, and (2) this device must accept any interference received, including interference that may cause undesired operation.

Visit https://global.uniview.com/Support/Download_Center/Product_Installation/Declaration/ for SDoC.

Caution: The user is cautioned that changes or modifications not expressly approved by the party responsible for compliance could void the user's authority to operate the equipment.

NOTE: This equipment has been tested and found to comply with the limits for a Class A digital device, pursuant to part 15 of the FCC Rules. These limits are designed to provide reasonable protection against harmful interference when the equipment is operated in a commercial environment. This equipment generates, uses, and can radiate radio frequency energy and, if not installed and used in accordance with the instruction manual, may cause harmful interference to radio communications. Operation of this equipment in a residential area is likely to cause harmful interference in which case the user will be required to correct the interference at his own expense.

LVD/EMC Directive



This product complies with the European Low Voltage Directive 2014/35/EU and EMC Directive 2014/30/EU.

WEEE Directive-2012/19/EU



The product this manual refers to is covered by the Waste Electrical & Electronic Equipment (WEEE) Directive and must be disposed of in a responsible manner.

Battery Regulation- (EU) 2023/1542



Battery in the product complies with the European Battery Regulation (EU) 2023/1542. For proper recycling, return the battery to your supplier or to a designated collection point.

1 Packing List

Contact your local dealer if the package is damaged or incomplete. The package contents may vary with device model.

No.	Name	Qty	Unit
1	Camera	1	PCS
2	Mount accessories ⁽¹⁾	1	Set
3	Screw components ⁽²⁾	1	Set
4*	User manual	1	Set

Remarks:

* means optional and supplied with certain models only.

(1) Including one or more waterproof components such as tape and plug.

(2) Including one or more items from screws, hex key, etc.

(3) Including one or more items from drill template, bracket adapter, antistatic gloves, etc.

2 Safety and Compliance Information

2.1 Installation

- When connecting the alarm input interface, make sure the high level signal of the alarm input does not exceed 5V DC.
- When the optical module is working, do not look directly at the optical module and fiber connector (applicable to devices with laser interface).
- If the device is installed on a wall or ceiling, make sure the mounting position is strong enough to withstand the device and the device is securely installed.
- Make sure the length of the power cable between the power adapter and the camera is not too long, otherwise the voltage of the camera is lowered, causing the camera to work abnormally. If it is required to lengthen the power cable, lengthen the cable between the power adapter and the mains.

- When connecting to an external interface, use an existing connection terminal, and ensure that the cable terminal (latch or clamp) is in good condition and properly fastened. Ensure that the cable is not tense during mounting, with a proper margin reserved to avoid poor port contact or loosening caused by shock or shake.
- Do not excessively bend or drag cables during installation.
- Do not aim the device at the sun or any strong light source for a long time, otherwise the imaging components may be damaged.
- During the process of transportation, special attention is required for the protection of the transparent dome cover to prevent friction, scratch and contamination, etc. In order to keep the cover clean, do not remove the protective film on the cover during mounting. After mounting is finished, remove the film before the device is powered on.
- Keep the device from squeezing, vibration and moisture during transportation, storage and installation, and try to keep away from the vibration source during installation.
- Take effective measures to protect the power cord from being tramped or pressed. The grounding terminal must be connected to ground.
- Contact professionals for maintenance information. Do not attempt to dismantle the device by yourself. We shall not assume any responsibility for problems caused by unauthorized repair or maintenance.

2.2 Maintenance

- If there is dust on the lens or the front glass surface, remove the dust gently using an oil-free brush or a rubber dust blowing ball.
- If there is grease or a dust stain on the front glass surface, clean the glass surface gently from the center outward using anti-static gloves or an oil-free cloth. If the grease or the stain still cannot be removed, use anti-static gloves or an oil-free cloth dipped with detergent and clean the glass surface gently until it is removed.
- Do not use organic solvents, such as benzene or ethanol when cleaning the transparent dome cover.



3 Appearance

3.1 Dimensions

The appearance may vary with device model. The figures below are only for illustrative purpose. The actual device appearance may be different.

Interface	Description
1000BASE-X	SFP optical module slot (with a dustproof cover)
LINK/ACT	Optical status indicator Note: Steady on: Connection established. Blinking: Data transmission.
ACT	Ethernet interface data transmission indicator
LINK	Ethernet interface network connection indicator
POE	Ethernet interface (only available for some models)
ALM IN/OUT	Alarm input/output
RS485	RS485 serial port
UART/USB2.0	UART interface for UART and USB connection
LINE IN/OUT	Audio input/output
DC/AC	Power connector, DC 12V/AC 24V
RST	RST button
ABF	ABF button (for adjusting the back focus) Note: Fine-tune the back focus to get clear images.
SD	Micro SD card slot

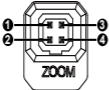
3.2.2 Side Panel Interface

Interface	Description
	Iris control interface
	Zoom control interface 1. ZOOM_A- 2. ZOOM_A+ 3. ZOOM_B- 4. ZOOM_B+
	Focus control interface 1. FOCUS_A- 2. FOCUS_A+ 3. FOCUS_B- 4. FOCUS_B+

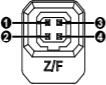
Interface	Description
 <p>The diagram shows a rectangular connector with four pins. Pin 1 is on the top left, pin 2 on the top right, pin 3 on the bottom right, and pin 4 on the bottom left. The connector is labeled 'Z/F' at the bottom.</p>	<p>Zoom/Focus control interface</p> <p>1. FOCUS+ 2. FOCUS-</p> <p>3. ZOOM+ 4. ZOOM-</p>

4 Mount Your Camera

4.1 (Optional) Insert Micro SD Card

You need to install a Micro SD card if you want to save video on an on-board SD card.



NOTE!

- Please consult your dealer or technical support for the recommended SD card specifications.
- Before you insert or remove the Micro SD card, be sure to disconnect power and wait till the camera stops operation; otherwise, the camera and the Micro SD card may be damaged.
- Please format the Micro SD card before use. The SD card can be formatted on the camera's Web interface.
- The Micro SD slots of some device models do not have dustproof covers, so skip the steps for opening/closing dustproof cover.

1. Loosen the screw on the dustproof cover, and remove the dustproof cover.

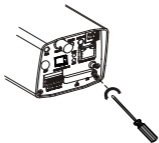

2. Insert the Micro SD card as shown, and then reinstall the dustproof cover.

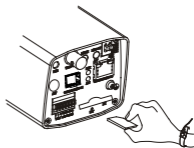

4.2 (Optional) Mount Optical Module



NOTE!

- The optical module is only supported by some models.
- Select a proper optical module according to the environment temperature. For outdoor mounting, the upper temperature limit of the optical module must be higher than 85°C.
- The bending angle of the optical fiber cannot be less than 90°.

To mount an SFP optical module, follow the steps below.

1. Remove the slot dustproof cover.

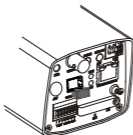

2. Insert the optical module.

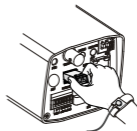

3. Insert the optical fiber connector into the SFP optical module.

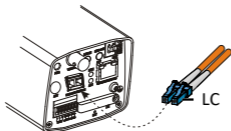

Note:

When using a single-fiber optical module, please connect the optical module to the external network switch using the same fiber optic cable (e.g., if you use the FIBER, 0 cable to connect the optical module, you must also use the FIBER, 0 cable to connect to the network switch).

4.3 Mount the Camera



NOTE!

- The universal joint, strap, clamp and bracket used in the following installation need to be purchased separately.
- There is no housing for wall mount.

4.3.1 Wall Mount

1. Locate the positions of the holes.

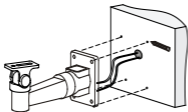

2. Select a drill bit that matches the outer diameter of the expansion bolt, and then drill holes with reference to the length of the expansion bolt.

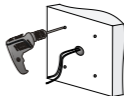

3. Hammer the expansion bolts into the holes.

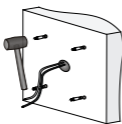

4. Mount the bracket onto the wall. Fix the bracket to the expansion bolts, and lock the bracket using flat washers, spring washers, and nuts (1: lead cables out of the leading-out hole of the bracket).

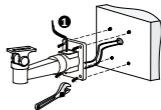

5. Mount the lens and then mount the camera onto the bracket.

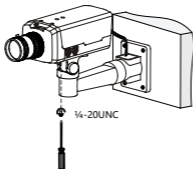

4.3.2 Pole Mount

The following is an illustration of horizontal pole mount. Other pole mount methods are similar to horizontal pole mount and therefore is not described separately.

1. Select a suitable housing and remove the base plate.

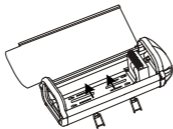

2. Fix the camera on the base plate (1: 1/4-20UNC).

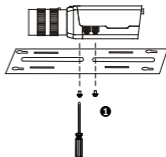

3. Reinstall the base plate. Tighten the four tapping screws as shown.

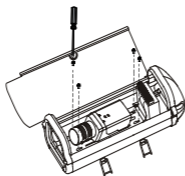

4. Loosen two screws on the universal joint, and fix the universal joint on the back of the housing (2: 1/4-20UNC).

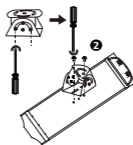

5. Fix the strap on the horizontal pole (1: tighten the strap; 2: lead cables through the horizontal pole).

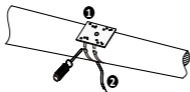

6. Connect the power cable and the network cable. Lead the cables through the cable hole on the housing to connect to the camera. Fix the housing on the strap. Adjust the universal joint or housing to adjust the monitoring direction.

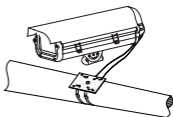

5 Startup

Check that the device is properly installed, then connect power to start up the device.

When the power connector is connected to the camera, the system status indicator on the camera panel will light up, and the green light indicates the camera started successfully.

6 Web Login

Default IP address:

198.168.1.13

Default

username/password:

admin / 123456

Note:

For security, please set a strong password of at least nine characters including uppercase and lowercase letters, digits, and special characters. You are strongly recommended to regularly change the device password and keep it secure to ensure that only authorized users can log in.

7 FAQ

1.The system does not prompt me to install the plug-in at my first login on Win 7.

Follow the steps to turn off UAC on your computer: open Control Panel. Type uac in the search box, and then click **Change User Account Control Settings**. Drag the slider to **Never Notify** and then click **OK**. After UAC is turned off, please log in again.

2.Failed to install the plug-in?

Before you log in, follow the steps to add the camera's IP to the trusted sites in your IE: Click **Tool> Internet Options > Security**. Click **Trusted sites**, click **Sites**, and then add the camera's IP address. If you are using Win 7, you also need to save the setup.exe to your computer first, and then right-click the file and select **Run as administrator**.

3.No live videos after first login?

Please turn off the firewall on your computer and then log in again.

4.How to restore factory default settings?

Remove the back cover, use a suitable pointed object like a toothpick or paper clip to press and hold the RST button for 15 seconds to restore defaults. The reset button only works within 10 minutes after the camera is connected to power.