

MultiView Network PTZ Dome Camera Quick Guide



V1.01

Preface

The content of this section is designed to ensure that users use the product correctly to prevent dangers or property loss caused by improper operation. Before using this product, be sure to read this manual carefully. Please keep this manual properly for future reference.

About This Manual

- We recommend that you use this manual under the guidance of a professional.
- This manual is designed for use with multiple product models, and it is not possible to list the appearance and functions of each product individually. Please refer to the actual product for use.
- This manual is intended for multiple software versions, and the illustrations and descriptions in this manual may be different from the actual GUI and functions of the software.
- Despite our best efforts, technical or typographical errors may exist in this manual. Uniview cannot be held responsible for any such errors and reserves the right to change the manual without prior notice.
- Users are fully responsible for the damages and losses that arise due to improper operation.
- Uniview reserves the right to change any information in this manual without any prior notice or indication. Due to such reasons as product version upgrade or regulatory requirement of relevant regions, this manual will be periodically updated.
- This manual will be updated in real time according to the laws and regulations of the relevant regions. For specific details, please refer to the product's paper copy, QR code, or official website. In case of any discrepancy between the paper copy and the electronic version, the electronic version shall prevail.

About This Product

If the product you have chosen is a video product, please strictly adhere to the applicable laws and regulations. You can visit our official website to inquire about the relevant content.

Instructions for Use

- This document serves as a guide for use only. All statements, information, and suggestions contained in this document do not constitute any express or implied warranty.
- We assume no responsibility for any special, incidental, consequential, or indirect damages resulting from the use of this manual or the use of our products, including but not limited to losses due to loss of business profits, data or document loss, and product malfunction or information leakage caused by cyber-attack, hacker attack, and virus infections.
- Due to uncertain factors such as the physical environment, there may be discrepancies between the actual values of some data and the reference values provided in the manual. In case of any questions or disputes, the company's final interpretation shall prevail.



Formatting Conventions

The UI formatting conventions used in this document are as follows:

| Format | Meaning |
|--------|---|
| Bold | Bold means UI elements (button names, menu names, window names, etc.), e.g., Click Save . |
| > | Indicate a sequence of actions, e.g., click Device Management > Add Device, which means first click Device Management, and then click Add Device. |

Symbol Conventions

This document uses various distinctive symbols to highlight areas that require special attention during the operation process. The meanings of these symbols are as follows:

| Symbol | Meaning |
|---|---|
|  | NOTE: Provides tips and additional information related to the operation and use of the product. |
|  | CAUTION: Alerts to matters that requires attention during operation, as improper handling may lead to product damage, data loss, or functional abnormalities. |
|  | WARNING: The annotations following this symbol demand extra attention, as improper handling could potentially cause personal injury. |

Legal Statement

Copyright Statement

©2025-2026 Zhejiang Uniview Technologies., Co., Ltd. All rights reserved.

All parts of this document, including but not limited to text, images, and graphics, are copyrighted and belong to Zhejiang Uniview Technologies Co., Ltd (hereinafter referred to as "Uniview" "we" "us"). Without our written permission, no organization or individual may excerpt, copy, translate, modify, or disseminate any part or all of the content of this manual in any form.

The products described in this manual may contain software copyrighted by us and any potential licensors. Without the permission of the relevant rights holders, no one may copy, distribute, modify, excerpt, decompile, disassemble, decrypt, reverse engineer, rent, transfer, sublicense, or engage in any other actions that infringe upon the software copyright in any form.

Trademark Acknowledgements

 are trademarks or registered trademarks of Uniview.

All other trademarks, products, services and companies in this manual or the product described in this manual are the property of their respective owners.

Export Compliance Statement

Uniview complies with applicable export control laws and regulations worldwide, including that of the People's Republic of China and the United States, and abides by relevant regulations relating to the export, re-export and transfer of hardware, software and technology. Regarding the product described in this manual, Uniview asks you to fully understand and strictly abide by the applicable export laws and regulations worldwide.

EU Authorised Representative

UNV Technology EUROPE B.V. Treubstraat 1, 2288 EG, Rijswijk, Netherlands.

If you have any feedback, please contact us at service@uniview.com.

Disclaimer of Liability

- We assume no responsibility and offer no compensation for any special, incidental, consequential, or indirect damages resulting from the use of this manual or our products, including but not limited to losses related to lost business profits, data, or document loss.
- The product described in this manual is provided on an "as is" basis. Unless required by applicable law, this manual is only for informational purpose, and all statements, information, and recommendations in this manual are presented without warranty of any kind, expressed or implied, including, but not limited to, merchantability, satisfaction with quality, fitness for a particular purpose, and noninfringement.
- Users must assume total responsibility and all risks for connecting the product to the Internet, including, but not limited to, network attack, hacking, and virus. Uniview strongly recommends that

users take all necessary measures to enhance the protection of network, device, data and personal information. Uniview disclaims any liability related thereto but will readily provide necessary security related support.

- To the extent not prohibited by applicable law, in no event will Uniview and its employees, licensors, subsidiary, affiliates be liable for results arising out of using or inability to use the product or service, including, not limited to, loss of profits and any other commercial damages or losses, loss of data, procurement of substitute goods or services; property damage, personal injury, business interruption, loss of business information, or any special, direct, indirect, incidental, consequential, pecuniary, coverage, exemplary, subsidiary losses, however caused and on any theory of liability, whether in contract, strict liability or tort (including negligence or otherwise) in any way out of the use of the product, even if Uniview has been advised of the possibility of such damages (other than as may be required by applicable law in cases involving personal injury, incidental or subsidiary damage).
- To the extent allowed by applicable law, in no event shall Uniview's total liability to you for all damages for the product described in this manual (other than as may be required by applicable law in cases involving personal injury) exceed the amount of money that you have paid for the product.
- When using this product, please strictly adhere to the applicable laws and regulations to avoid infringing upon the rights of third parties, including but not limited to intellectual property rights, data rights, or other privacy rights. You must also not use this product for the purposes of developing or facilitating the use of weapons of mass destruction, biological or chemical weapons, nuclear weapons, or for any other purposes that violate international norms and regulations.

Privacy Protection Reminder

Uniview complies with appropriate privacy protection laws and is committed to protecting user privacy. You may want to read our full privacy policy at our website and get to know the ways we process your personal information. Please be aware, using the product described in this manual may involve the collection of personal information such as face, fingerprint, license plate number, email, phone number, GPS. Please abide by your local laws and regulations while using the product.

Safety Precautions

The device must be installed, serviced and maintained by a trained professional with necessary safety knowledge and skills. Before you start using the device, please read through this guide carefully and make sure all applicable requirements are met to avoid danger and loss of property.

Storage, Transportation, and Use

- Store or use the device in a proper environment that meets environmental requirements, including and not limited to, temperature, humidity, dust, corrosive gases, electromagnetic radiation, etc.
- Make sure the device is securely installed or placed on a flat surface to prevent falling.
- Unless otherwise specified, do not stack devices.
- Ensure good ventilation in the operating environment. Do not cover the vents on the device. Allow adequate space for ventilation.
- Protect the device from liquid of any kind.
- Make sure the power supply provides a stable voltage that meets the power requirements of the device. Make sure the power supply's output power exceeds the total maximum power of all the connected devices.
- Verify that the device is properly installed before connecting it to power.
- Do not remove the seal from the device body without consulting Uniview first. Do not attempt to service the product yourself. Contact a trained professional for maintenance.
- Always disconnect the device from power before attempting to move the device.
- Take proper waterproof measures in accordance with requirements before using the device outdoors.

Power Requirements

- Install and use the device in strict accordance with your local electrical safety regulations.
- Use a UL certified power supply that meets LPS requirements if an adapter is used.

- Use the recommended cordset (power cord) in accordance with the specified ratings.
- Only use the power adapter supplied with your device.
- Use a mains socket outlet with a protective earthing (grounding) connection.
- Ground your device properly if the device is intended to be grounded.

Battery Safety

Please use batteries properly; otherwise, there is a risk of fire or explosion.

- **Warning:** Using incorrect battery models can lead to explosion.
- If you need to replace the battery, it is recommended that you go to an authorized service center or have it replaced under professional supervision. We shall not be held responsible for any issues arising from unauthorized battery replacement.
- When replacing the battery, be sure to use a battery of the same type as the original! Using the wrong model for replacement (such as certain types of lithium batteries) may cause safety protection to fail.
- Batteries must not be exposed to overheat environments such as sunlight, fire, as this may lead to fire, explosion, or combustion.
- Do not dispose of batteries in fire or heating appliances. Do not squeeze, bend, or cut batteries, as it may cause explosion.
- Do not expose batteries to extremely high or low temperatures, or to very low-pressure environments, as this may cause explosion or leakage of flammable liquid/gas.
- Dispose of the used battery according to your local regulations or the battery manufacturer's instructions.
- For products or the included remote control containing a button cell battery: Do not ingest the battery - chemical burn hazard! If swallowed, a button cell battery can cause severe internal burns within 2 hours and may be fatal. Precautions (including but not limited to):
 - Keep new and used batteries away from children.
 - Stop using the product and keep it away from children if the battery compartment is not securely closed.
 - If you suspect that a battery may have been swallowed or inserted inside any part of the body, seek immediate medical attention.

Network Security

Please take all necessary measures to enhance network security for your device.

The following are necessary measures for the network security of your device:

- **Change default password and set strong password:** You are strongly recommended to change the default password after your first login and set a strong password of at least nine characters including all three elements: digits, letters and special characters.
 - Do not include the account name or the reverse of the account name.
 - Avoid using consecutive characters, such as 123, abc, etc.
 - Do not use overlapping characters, such as 111, aaa, etc.
- **Keep firmware up to date:** It is recommended that your device is always upgraded to the latest version for the latest functions and better security. Visit Uniview's official website or contact your local dealer for the latest firmware.

The following are recommendations for enhancing network security of your device:

- **Change password regularly:** Change your device password on a regular basis and keep the password safe. Make sure only the authorized user can log in to the device.
- **Enable HTTPS/SSL:** Use SSL certificate to encrypt HTTP communications and ensure data security.
- **Enable IP address filtering:** Allow access only from the specified IP addresses.
- **Minimum port mapping:** Configure your router or firewall to open a minimum set of ports to the WAN and keep only the necessary port mappings. Never set the device as the DMZ host or configure a full cone NAT.
- **Disable the automatic login and save password features:** If multiple users have access to your computer, it is recommended that you disable these features to prevent unauthorized access.

- **Choose username and password discreetly:** Avoid using the username and password of your social media, bank, email account, etc., as the username and password of your device, in case your social media, bank and email account information is leaked.
- **Restrict user permissions:** If more than one user needs access to your system, make sure each user is granted only the necessary permissions.
- **Disable UPnP:** When UPnP is enabled, the router will automatically map internal ports, and the system will automatically forward port data, which results in the risks of data leakage. Therefore, it is recommended to disable UPnP if HTTP and TCP port mapping have been enabled manually on your router.
- **Multicast:** Multicast is intended to transmit video to multiple devices. If you do not use this function, it is recommended you disable multicast on your network.
- **Check logs:** Check your device logs regularly to detect unauthorized access or abnormal operations.
- **Isolate video surveillance network:** Isolating your video surveillance network with other service networks helps prevent unauthorized access to devices in your security system from other service networks.
- **Physical protection:** Keep the device in a locked room or cabinet to prevent unauthorized physical access.
- **SNMP:** Disable SNMP if you do not use it. If you do use it, then SNMPv3 is recommended.

Learn More

You may also obtain security information under Security Response Center at Uniview's official website.

Avertissement de l'utilisation de la batterie

- Lorsque utiliser la batterie, évitez:
 - Température et pression d'air extrêmement élevées ou basses pendant l'utilisation, le stockage et le transport.
 - Remplacement de la batterie.
- Utilisez la batterie correctement. Mauvaise utilisation de la batterie comme celles mentionnées ici, peut entraîner des risques d'incendie, d'explosion ou de fuite liquide de gaz inflammables.
 - Remplacer la batterie par un type incorrect;
 - Disposer d'une batterie dans le feu ou un four chaud, écraser mécaniquement ou couper la batterie;
- Disposer la batterie utilisée conformément à vos règlements locaux ou aux instructions du fabricant de la batterie.

Regulatory Compliance

FCC Statements

This device complies with Part 15 of the FCC Rules. Operation is subject to the following two conditions: (1) this device may not cause harmful interference, and (2) this device must accept any interference received, including interference that may cause undesired operation.

Visit https://global.uniview.com/Support/Download_Center/Product_Installation/Declaration/ for SDoC.

Caution: The user is cautioned that changes or modifications not expressly approved by the party responsible for compliance could void the user's authority to operate the equipment.

NOTE: This equipment has been tested and found to comply with the limits for a Class A digital device, pursuant to part 15 of the FCC Rules. These limits are designed to provide reasonable protection against harmful interference when the equipment is operated in a commercial environment. This equipment generates, uses, and can radiate radio frequency energy and, if not installed and used in accordance with the instruction manual, may cause harmful interference to radio communications. Operation of this equipment in a residential area is likely to cause harmful interference in which case the user will be required to correct the interference at his own expense.

LVD/EMC Directive



This product complies with the European Low Voltage Directive 2014/35/EU and EMC Directive 2014/30/EU.

WEEE Directive–2012/19/EU



The product this manual refers to is covered by the Waste Electrical & Electronic Equipment (WEEE) Directive and must be disposed of in a responsible manner.

Battery Regulation- (EU) 2023/1542



Battery in the product complies with the European Battery Regulation (EU) 2023/1542. For proper recycling, return the battery to your supplier or to a designated collection point.

Waterproof Requirements

Please waterproof cables in accordance with the following instructions. User shall assume all responsibility for device damage caused by water due to improper waterproof measures.



NOTE!

- Before you start, connect all the needed cables and cut off the copper wires for the cables that you don't use.
- Please use self-adhesive waterproof tape (supplied with some products) to protect the cables.
- Use waterproof components to protect the network cable. Waterproof the power cable separately if you don't use it. The video cable does not need waterproof treatment.

1. Use insulation tape (not included in the package) to insulate the connection part of each cable.

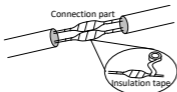

2. Waterproof the cables with self-adhesive waterproof tape.

- (1) Fully stretch the waterproof tape at both ends.
- (2) Wrap the connection part and the cable ends tightly with waterproof tape. Make sure the tape is fully stretched during the process.
- (3) Tighten the tape at both ends to prevent water leakage.

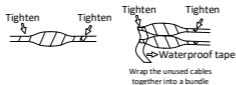

3. Install the supplied waterproof components to the network cable in sequence.

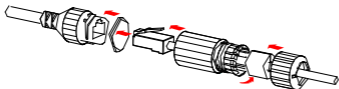

i CAUTION!

You need to mount the rubber ring onto the network cable interface first.

4. If your camera has a DC cable and you will not use it, insert the plug into the interface.

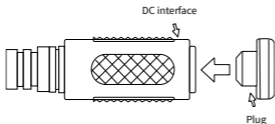

5. (Optional) After the waterproof treatment is completed, put the cables into a waterproof junction box (purchased separately).

i CAUTION!

- The cable connector must not be exposed and must be kept away from water.
- Restore and fasten the device after dismounting.
- Place the power adapter in a power distribution box.

1 Packing List

The package contents may vary with device model and version.

| No. | Name | Qty | Unit |
|-----|--------------------------------------|-----|------|
| 1 | Device | 1 | PCS |
| 2 | Waterproof components ⁽¹⁾ | 1 | Set |
| 3 | Screw components ⁽²⁾ | 1 | Set |
| 4 | Quick mounting plate | 1 | PCS |
| 5 | Product documents | 1 | Set |

Remarks: * means the item is supplied with certain models only.

(1) Including one or more waterproof components such as tape and plug.

(2) Including one or more items from screws, hex key, etc.

2 Safety Information

2.1 Precautions

- Avoid environments with extremely low and high temperatures, humidity, dust, vibration, etc. during installation and use. Keep away from heating, stoves, underside of bridges, etc. See the latest product datasheet for the detailed temperature and humidity requirements.
- Do not install the device in environments with strong electromagnetic interference, such as the circuit breaker area of a substation, near area of the power transmission lines, main transmission direction of the broadcast tower antenna, and near area of track pantograph, radar, and base station antenna. Otherwise, the device may be damaged.
- Do not use the device in environments with strong corrosiveness, strong acids, and high salinity and alkalinity, such as offshore islands, offshore platforms, chemical industry work areas, and nearshore area within 5 kilometers of the coast. Ensure that appropriate corrosion protection measures are taken if installation in special environments is required.
- If the device is installed on a wall or ceiling, make sure the device is securely installed; use the safety rope during installation to prevent the device from falling.
- During the process of transportation, special attention is required for the protection of the transparent dome cover to prevent friction, scratch and contamination. In order to keep the cover clean, do not remove the protective film on the cover during mounting. After mounting is finished, remove the film before the device is powered on.
- Do not overbend or drag cables during installation; otherwise, poor cable contact may cause malfunction.
- When connecting to an external interface, use an existing connection terminal, and ensure that the cable terminal (latch or clamp) is in good condition and properly fastened.
- When connecting the alarm input interface, make sure the high level signal of the alarm input does not exceed 5V DC.
- Protect the power cord from being trampled or crushed, especially at the plug, outlet, and the connection points between the cable and the device. A separate ground terminal must always be connected to ground.
- Make sure that the power has been disconnected before you maintain or move the device.
- Some devices are equipped with a white-light illuminator. For these devices, note the following.



Do not stare at operating lamp. May be harmful to the eyes.
Ne pas regarder la lampe de fonctionnement. Peut être nocif pour les yeux.

- Some devices are equipped with an infrared illuminator. For these devices, note the following.



Avoid eye exposure. Use appropriate shielding or eye protection.
Évitez l'exposition aux yeux. Utilisez un blindage approprié ou une protection oculaire.

2.2 Maintenance

- If there is dust on the front glass surface, remove the dust gently using an oil-free brush or a rubber dust blowing ball.
- If there is grease or a dust stain on the front glass surface, clean the glass surface gently from the center outward using anti-static gloves or an oil-free cloth. If the grease or the

stain still remains, use anti-static gloves or an oil-free cloth dipped with detergent and clean the glass surface gently.

- Do not use organic solvents (benzene, alcohol, etc.) to clean the transparent dome cover.

3 Product Appearance

3.1 Dimensions

The appearance may vary with device model. The figures below are for illustrative purpose only.

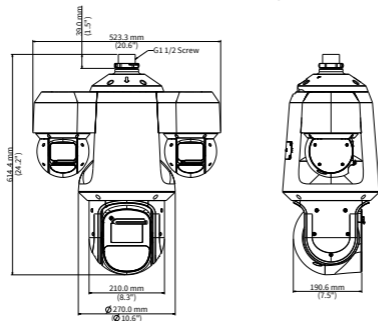

3.2 Tail Cable

The tail cable may vary with device model.

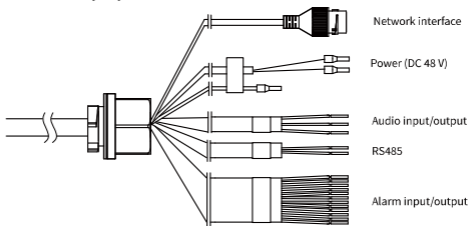

4 Product Installation

4.1 Check Before Installation

1. Check package contents

Check against the packing list to ensure all components are complete.

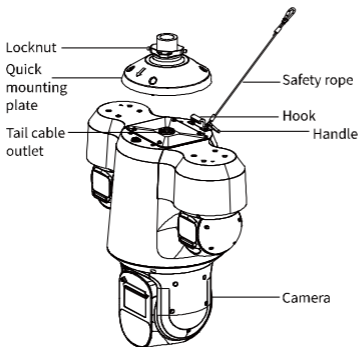

2. Check the strength of the installation site

The strength requirements for the installation site may vary depending on the installation method. Ensure the strength of the installation site meets the load-bearing requirements. Reinforce it before installation if necessary.

3. Lightning protection and grounding requirements

Choose appropriate lightning protection equipment for the power, audio, video, and RS485 signal cables of the device.

4. Accessories

For the needed brackets and accessories (such as wall mount bracket), please refer to our recommended accessory list for detailed models.

4.2 (Optional) Install SD Card

You need to install a Micro SD card first if you want to use the edge storage function.



NOTE!

- Please format the Micro SD card before use. The SD card can be formatted on the camera's Web interface.
- For the recommended Micro SD card specifications, please contact your dealer or our technical support.

The figures below are for illustrative purpose only. The actual position of the Micro SD card slot may vary.



CAUTION!

- Before you insert or remove the Micro SD card, be sure to disconnect power and wait till the camera stops operation; otherwise, the camera or the Micro SD card may be damaged.
- Do not disassemble the device in a humid environment as the humidity inside the device will cause fogging.

1. Remove the four screws on the rear cover.
2. Insert the Micro SD card into the slot.
3. Check that the sealing ring on the rear cover is in position.
4. Attach the rear cover, tighten the screws.

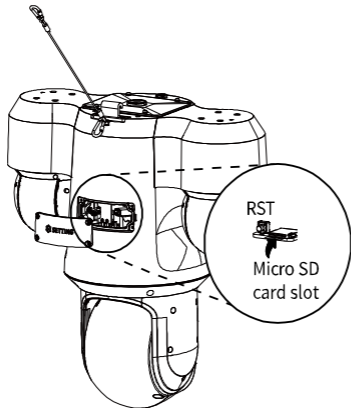

4.3 Set Installation Direction



NOTE!

The arrow on the quick mounting plate indicates the installation direction. Adjust the installation direction according to actual requirements.

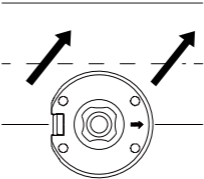
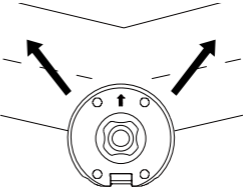
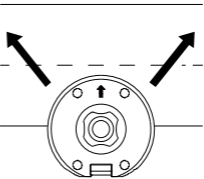
| | |
|--|---|
| <p>Two small domes face the same direction (1 road)</p> |  <p>A</p> |
| <p>Two small domes face different directions (2 roads)</p> |  <p>B</p> |
| <p>Two small domes face different directions (1 road)</p> |  <p>C</p> |

4.4 Device Installation

4.4.1 Wall Mount



CAUTION!

- The screws connecting the bracket, adapter ring, and other nodes of the camera must be securely fastened in place and not missing.
- Make sure to perform waterproof treatment on the connection part between the camera and bracket, wall veneer gaps, and cable outlets on the wall.
- The length of the wall mount bracket chosen must be greater than the radius of the PTZ dome camera.

1. After securing the pole mount bracket to the pole, lead out the external cables.

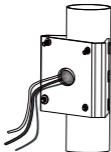

2. Install the wall mount bracket onto the pole mount bracket.

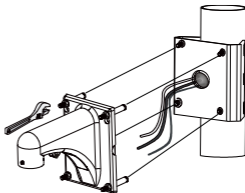

3. Tighten the quick mounting plate and mount it onto the wall mount bracket.

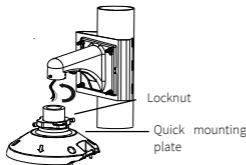

4. Lift the camera through its handle, attach the hook to the quick mounting plate, then secure the safety rope onto the bracket ring or locknut ring, and finally release the handle.

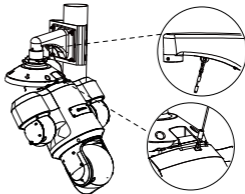

5. Connect the external cables with the camera's tail cable. After completing the connection, tighten the 4 anti-loosening screws.

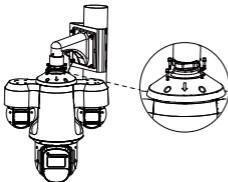

6. Adjust the quick mounting plate until the arrow points toward the monitoring direction (see [3.3 Set Installation Direction](#)). Next, tighten the locknut in the opposite direction (relative to the quick mounting plate's installation direction), and secure the wall mount bracket screws.

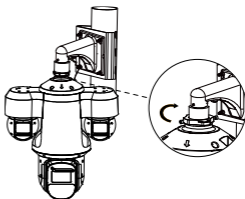

4.4.2 Pendant Mount



CAUTION!

- For outdoor use, ensure waterproofing requirements are met. We will not be liable for any consequences resulting from water ingress due to inadequate waterproofing.
- User-customized poles must also meet waterproofing requirements to prevent water ingress and accumulation.
- The tail cable must be waterproofed and must not be exposed to the outside. The area around the tail cable must be properly waterproofed to prevent soaking in water. The connection between the camera and the pole must be sealed and waterproofed.
- Before starting installation, confirm the stability of the pole to prevent shaking.

1. After fixing the pole to the ceiling, lead the cable out from the pole, prepare to install the quick mounting plate.

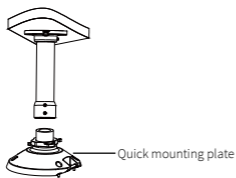

2. Secure the quick mounting plate onto the pole, adjust the quick mounting plate until the arrow points toward the monitoring direction (see [3.3 Set Installation Direction](#)), and then tighten the locknut in the opposite direction (relative to the quick mounting plate's installation direction).

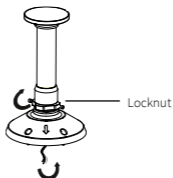

3. Tighten the screws on the pole and the locknut.

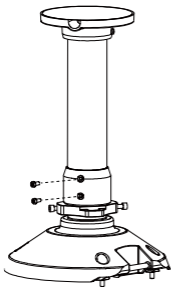

4. Lift the camera through its handle, secure the safety rope onto the locknut ring, then attach the hook to the quick mounting plate, and finally release the handle.

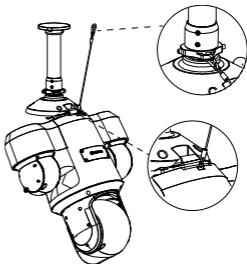

5. Connect the external cables with the camera's tail cable. After completing the connection, tighten the 4 anti-loosening screws.

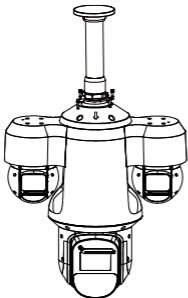

4.4.3 Standing Pole Mount

The standing pole mount requires a pole mount bracket and a wall mount bracket. These brackets are not included with the device and must be purchased separately.

1. Install the pole mount bracket onto the pole.
 - (1) Insert 4 short bolts from the rear through the front cover of the pole mount bracket.
 - (2) Thread 2 cable ties from the front through the front cover of the pole mount bracket and tighten them at the appropriate position on the pole.
 - (3) Place flat washers and spring washers onto 4 long bolts. Then, insert them from the front through the front cover and connect them to the rear cover of the pole mount bracket.
 - (4) Thread on 8 nuts. While using one wrench to hold the bolts in place, use another wrench to tighten all 8 nuts until they can no longer turn.

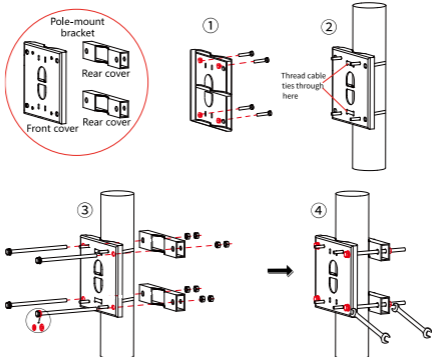

2. Install the wall mount bracket.

- (1) Route the cables through the front cover of the pole mount bracket first, and then through the wall mount bracket, ready for connection.
- (2) Align the holes of the wall mount bracket with the short bolts and slide it onto them. Then, install a flat washer, a spring washer, and a nut onto each bolt in sequence. While using one wrench to hold the bolt stationary, use another wrench to tighten the nut until it can no longer turn.

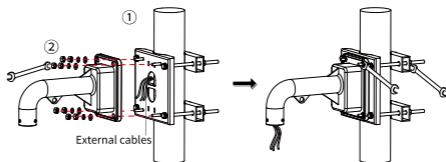

3. Connect the device to the wall mount bracket.

Attach the device's safety rope hook to the hole on the bracket. For other installation steps, please refer to [3.4.1 Wall Mount](#).

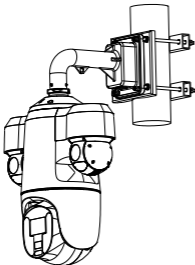

4.4.4 Horizontal Pole Mount

The horizontal pole mount requires a pole mount bracket and a pendant mount bracket. These brackets are not included with the device and must be purchased separately.

1. Install the pole mount bracket onto the pole.

- (1) Insert 4 short bolts from the rear through the front cover of the pole mount bracket.
- (2) Thread 2 cable ties from the front through the front cover of the pole mount bracket and tighten them at the appropriate position on the pole.
- (3) Place flat washers and spring washers onto 4 long bolts. Then, insert them from the front through the front cover and connect them to the rear cover of the pole mount bracket.
- (4) Thread on 8 nuts. While using one wrench to hold the bolts in place, use another wrench to tighten all 8 nuts until they can no longer turn.

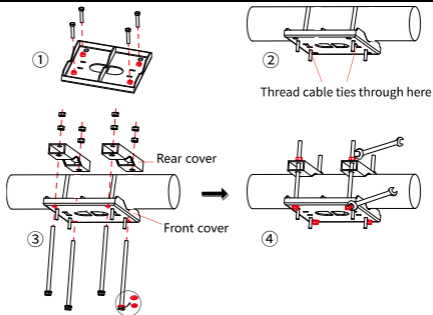

2. Install the pendant mount bracket.

- (1) Route the external cables through the front cover of the pole mount bracket first, and then through the pendant mount bracket, ready for connection.
- (2) Align the holes of the pendant mount bracket with the short bolts and slide it onto them. Then, install a flat washer, a spring washer, and a nut onto each bolt in sequence. While using one wrench to hold the bolt stationary, use another wrench to tighten the nut until it can no longer turn.

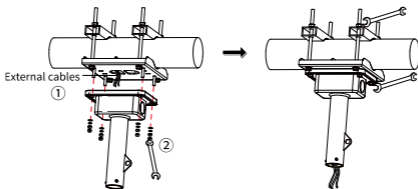

3. Connect the device to the pendant mount bracket.

Attach the device's safety rope hook to the hole on the bracket. For other installation steps, please refer to [3.4.2 Pendant Mount](#).

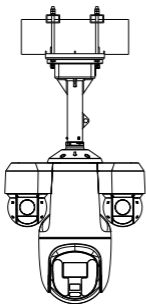

4.4.5 Horizontal Pole Mount

1. Connect the mounting plate to the pole mount bracket. Pass the four bolts through the mounting plate, aligning them with the four holes on the pole mount bracket, and use a wrench to tighten the four nuts.

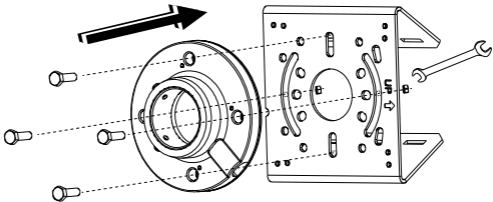

2. Install the pole mount bracket onto the pole.

- (1) Unfasten the three straps, pass them through the holes on the pole mount bracket.
- (2) Loop the straps around the pole, pass the cables through the holes on the bracket. Tighten the straps and secure them to the pole.

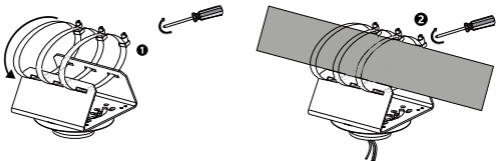

3. Refer to 3.4.2 Pendant Mount to complete device installation.

5 Startup

Check that the device is properly installed, and then connect power to start the device.

Each time the device is powered on, it will perform a self-check to test the basic functions such as pan, tilt, and zoom. You can operate the device only when the self-check is complete.

6 Web Login

Default IP address

192.168.1.13

Default

username/password

admin / 123456

Note:

For security, please set a strong password of at least nine characters including uppercase and lowercase letters, digits, and special characters after your first login. It is recommended to change the password on a regular basis and keep it secure to ensure that only authorized users can access the device.

7 FAQ

1. No live videos after first login?

Answer: Please turn off the firewall on your computer and then log in again.

2. How to restore factory default settings?

Answer: To restore factory default settings, use the following method within 10 minutes of powering on the device (this method is ineffective after 10 minutes).

- (1) Open the Micro SD card cover.
- (2) Press and hold the reset button for at least 10 seconds.