

## 2MP HD IR VF Dome Network Camera IPC3532LP-ADEZK-DI

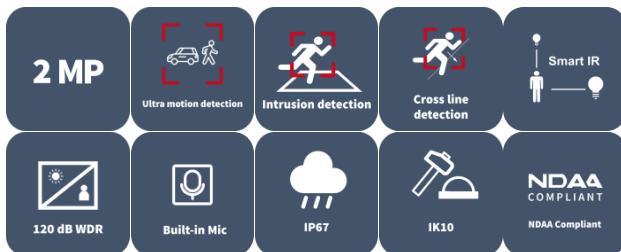

## Features

- High quality image with 1080P, 1/2.8" CMOS sensor
- 1080P (1920 × 1080)@30/25 fps; 720P (1280 × 720)@30/25 fps
- Ultra 265, H.265, H.264, MJPEG (Sub Stream Only)
- Smart intrusion prevention, including cross line, intrusion detection (based on human body detection)
- Support ultra motion detection (human/ vehicle detection)
- 120 dB true WDR technology enables clear image in strong light scene
- Built in mic
- Supports 9:16 corridor mode
- Smart IR, up to 40 m (131.2 ft.) IR distance
- MicroSD, up to 512 GB
- IK10 vandal resistant
- IP67 protection

## Specifications

Model	IPC3532LP-ADEZK-DI
<b>Camera</b>	
Max Resolution	2 MP
Sensor	1/2.8" CMOS
Min. Illumination	Color: 0.001 Lux (F1.6, AGC ON), 0 Lux with IR on
Day/Night	IR-cut filter with auto switch (ICR)
Shutter	Auto/Manual, 1 to 1/100000 s
Adjustment Angle	Pan: 3° to 360°, Tilt: 0° to 70°, Rotate: 3° to 360°
S/N	> 52 dB
WDR	120 dB
<b>Lens</b>	
Focal Length	2.8 to 12 mm
Iris	F1.6
Field of View (H)	104.5° to 34.9°
Field of View (V)	56.0° to 20.0°
Field of View (D)	124.5° to 40.1°
Lens Type	Motorized
Iris Type	Auto Iris
<b>DORI</b>	
DORI Distance (Lens)	2.8 to 12 mm
DORI Distance (Detect)	29.0 m to 124.1 m (95.0 ft. to 407.3 ft.)
DORI Distance (Observe)	14.5 m to 62.1 m (47.5 ft. to 203.6 ft.)
DORI Distance (Recognize)	7.0 m to 29.8 m (22.8 ft. to 97.7 ft.)
DORI Distance (Identify)	4.3 m to 18.6 m (14.3 ft. to 61.6 ft.)
<b>Illuminator</b>	
Illumination Distance (IR)	40 m (131.2 ft.)
Wavelength	850 nm
IR On/Off Control	Auto/Manual
<b>Video</b>	
Video Compression	Ultra 265, H.265, H.264, MJPEG (Sub Stream Only)
H.264 Code Profile	Baseline profile, Main profile, High profile
Frame Rate	Main Stream: 1080P (1920 × 1080), max. 30 fps; 720P (1280 × 720), max. 30 fps; Sub Stream: 720P (1280 × 720), max. 30 fps; D1 (720 × 576), max. 30 fps; 640 × 360, max. 30 fps; 2CIF (704 × 288), max. 30 fps; CIF (352 × 288), max. 30 fps;
Video Bit Rate	128 Kbps to 6144 Kbps
U-code	Support
OSD	Up to 4 OSDs
Privacy Mask	Up to 4 areas
ROI	Support
Video Stream	Dual streams
<b>Image</b>	





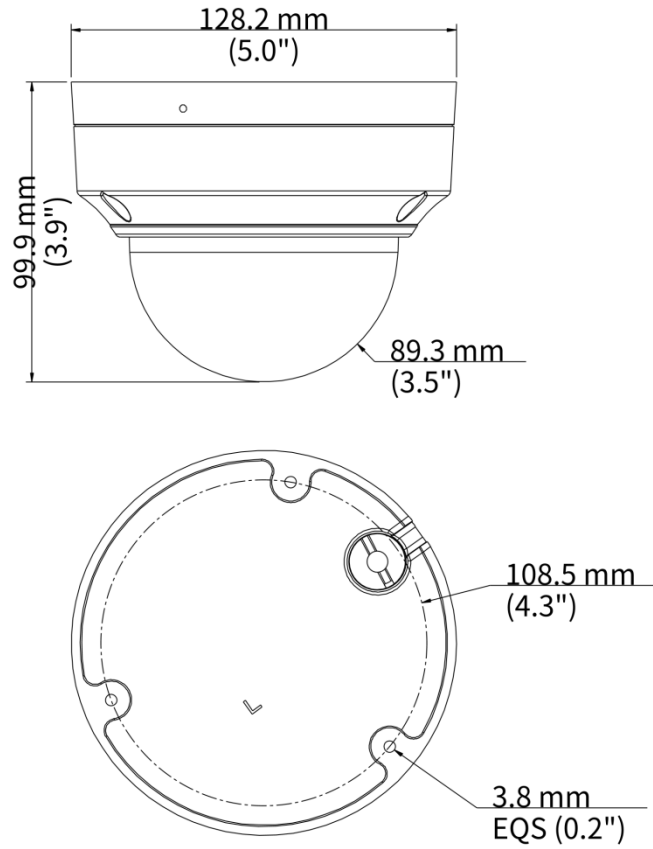

White Balance	Auto, Outdoor, Fine tune, Sodium lamp, Locked, Auto2, Area white balance
Digital Noise Reduction	2D/3D DNR
Smart IR	Support
Flip	Normal, Flip vertical, Flip horizontal, 180°, 90° Clockwise, 90° Anti-clockwise
Dewarping	N/A
HLC	Support
BLC	Support
Defog	Digital defog
<b>Events</b>	
Basic Detection	Motion detection, Ultra motion detection (human/ vehicle detection) , Tampering alarm, Audio detection, Cross line (based on human body detection), Intrusion (based on human body detection)
General Function	Watermark, IP address filtering, Access policy, ARP protection, RTSP authentication, User authentication, HTTP authentication
<b>Audio</b>	
Audio Compression	G.711U, G.711A, AAC-LC
Audio Bitrate	G.711U/G.711A: 64 kbps, AAC-LC: 128 kbps
Two-way Audio	N/A
Suppression	Support
Sampling Rate	G.711U/G.711A: 8 kHz, AAC-LC: 8 kHz, 16 kHz, 48 kHz
<b>Storage</b>	
Edge Storage	MicroSD, up to 512 GB
Network Storage	ANR, NAS (NFS)
<b>Network</b>	
Protocols	IPv4, IPv6, IGMP, ICMP, ARP, TCP, UDP, DHCP, RTP, RTSP, DNS, DDNS, NTP, FTP, UPnP, HTTP, HTTPS, SMTP, SSL/TLS, QoS, SNMP, PPPoE, RTCP, RTMP, 802.1x, SSH
Compatible Integration	ONVIF (Profile S, Profile G, Profile T), API, SDK
User/Host	Up to 32 users. 3 user levels: administrator, common user and operator
Security	Password protection, Strong Password, HTTPS encryption, Export operation logs, Basic and Digest Authentication for RTSP, Digest Authentication for HTTP, TLS 1.2, WSSE and Digest Authentication for ONVIF
Client	EZStation, APP
Web Browser	Plug-in required live view: IE 10+, Chrome 45+, Firefox 52+, Edge 79+, Plug-in free live view: Chrome 57+, Firefox 58+, Edge 16+
<b>Interface</b>	
Audio I/O	1 Input: impedance 35 kΩ, amplitude 2 V [p-p], 1 Output: impedance 600 Ω, amplitude 2 V [p-p]
Alarm I/O	1/1
Serial Port	N/A
Built-in Mic	Support
Built-in Speaker	N/A
WIFI	N/A
Network	1 × RJ45 10 M/100 M Base-TX Ethernet
Video Output	N/A

Certification	
EMC	CE-EMC (EN 55032, EN 61000-3-3, EN IEC 61000-3-2, EN 50130-4) FCC (FCC 47 CFR part15 B)
Safety	CE-LVD (EN 62368-1) UL/CUL (UL 62368-1, CAN/CSA C22.2 No. 62368-1)
Environment	CE-RoHS (2011/65/EU ; (EU) 2015/863) ; WEEE (2012/19/EU)
Protection	IP67 (IEC 60529) IK10 (IEC 62262)
General	
Power	DC 12 V±25%, PoE (IEEE 802.3af)
Power Consumption	Max. 6.3 W
Power Interface	Ø5.5 mm coaxial power plug
Dimensions	Ø128.2 mm × 99.9 mm (Ø5.0" × 3.9") (Ø × H)
Weight	0.66 kg (1.46 lb.)
Material	Metal
Working Environment	-30 °C to 60 °C (-22 °F to 140 °F), Humidity: ≤ 95% RH (non-condensing)
Storage Environment	-30 °C to 60 °C (-22 °F to 140 °F), Humidity: ≤ 95% RH (non-condensing)
Surge Protection	4 KV
Reset Button	Support
RTC	Support
Web Client Language	14 Languages: English, Simplified Chinese, Polish, German, Russian, French, Korean, Dutch, Czech, Portuguese, Spanish, Spanish (Europe), Italian, Turkish

## Dimensions



## Accessories

<p><b>TR-JB03-H-IN-V2</b> Junction Box for Metal Turret Camera(Support wiring from behind)</p>	<p><b>TR-A01-IN</b> NPT 3/4" Waterproof Cable Gland</p>	<p><b>TR-SE24-IN</b> Dome Pendant Mounting Pole 200mm</p>
		
<p><b>TR-SE24-A-IN</b> Dome Pendant Mounting Pole 500mm</p>	<p><b>TR-CM24-IN</b> Dome Pendant Mounting Bracket(Indoor)</p>	<p><b>TR-UC08-C-V2</b> Bullet&amp;Dome Corner Mounting Bracket</p>
		

<p><b>TR-JB07/WM03-F-IN-V2</b> Wall Mounting Assembling Bracket with Back Hole for 3 Inch Hemisphere</p>	<p><b>TR-WM03-B-IN-V2</b> Wall Mounting Assembling Bracket for 3 Inch Hemisphere</p>	<p><b>HS-207S</b> Sunshade Shell for Zoom Dome</p>
		
<p><b>TR-UP06-C-IN-V2</b> Pole Mounting Bracket for Bullet Junction Box Only</p>		
		

# Unlimited New View

## Zhejiang Uniview Technologies Co., Ltd.



<http://www.uniview.com>



[overseasbusiness@uniview.com](mailto:overseasbusiness@uniview.com); [globalsupport@uniview.com](mailto:globalsupport@uniview.com)



No. 369, Xietong Road, Xixing Sub-district, Binjiang District, Hangzhou City, 310051, Zhejiang Province, China



©2023-2025 Zhejiang Uniview Technologies Co., Ltd. All rights reserved.

\*Product specifications and availability are subject to change without notice.

Despite our best efforts, technical or typographical errors may exist in this document. Uniview cannot be held responsible for any such errors and reserves the right to change the contents of this document without prior notice.