

2MP WDR LightHunter IR Network Bullet Camera IPC2222SB-AHDF40KM-I1

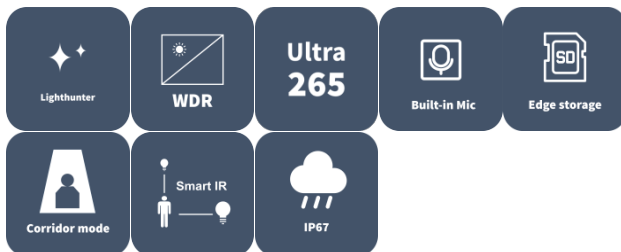

Features

- High quality image with 1080P, 1/2.8" CMOS sensor
- 1920 × 1080@60 fps in the main stream, delivers detailed live while 60 fps keeping it smooth and closer to the real image
- Ultra 265, H.265, H.264, MJPEG
- Smart intrusion prevention, supports cross line and intrusion based on human body and vehicle detection
- LightHunter technology ensures ultra-high image quality in low illumination environment
- Supports 9:16 corridor mode
- Up to 120 dB optical WDR (wide dynamic range)
- Supports smart IR, up to 80 m (262.5 ft.) IR range
- DC 12 V, PoE (IEEE 802.3af) power supply
- Alarm I/O: 1/1, audio I/O: 1/1
- Built-in mic
- IP67, IK10

Specifications

| Model | IPC2222SB-AHDF40KM-I1 |
|----------------------------------|---|
| Camera | |
| Sensor | 1/2.8" CMOS |
| Min. Illumination | Color: 0.001 Lux (F1.6, AGC ON), 0 Lux with IR |
| Day/Night | IR-cut filter with auto switch (ICR) |
| Shutter | Auto/Manual, 1 to 1/100000 s |
| WDR | 120 dB |
| S/N | >52 dB |
| Lens | |
| Focal Length | 4.0 mm |
| Iris | F1.6 |
| Field of View (H) | 86.9° |
| Field of View (V) | 44.7° |
| Field of View (D) | 106.9° |
| Iris Type | Fixed |
| DORI | |
| DORI Distance (Lens) | 4 mm |
| DORI Distance (Detect) | 62.1 m (203.7 ft.) |
| DORI Distance (Observe) | 24.8 m (81.4 ft.) |
| DORI Distance (Recognize) | 12.4 m (40.7 ft.) |
| DORI Distance (Identify) | 6.2 m (20.4 ft.) |
| Illuminator | |
| Illumination Distance (IR) | 80 m (262.5 ft.) |
| IR On/Off Control | Auto/Manual |
| Wavelength | 850 nm |
| Image | |
| Low Illumination Characteristics | LightHunter |
| Defog | Digital defog |
| White Balance | Auto, Outdoor, Fine tune, Sodium lamp, Locked, Auto2 |
| Digital Noise Reduction | 2D/3D DNR |
| Smart IR | Support |
| Flip | Normal, Flip vertical, Flip horizontal, 180°, 90° Clockwise, 90° Anti-clockwise |
| HLC | Support |
| BLC | Support |
| Heatwave Reduction | N/A |
| Video | |
| Privacy Mask | Up to 4 areas per scene |
| Frame Rate-Main Stream | 1080P (1920 × 1080), max. 60 fps |
| Frame Rate-Sub Stream | 720P (1280 × 720), max. 60 fps |
| Video Compression | Ultra 265, H.265, H.264, MJPEG |





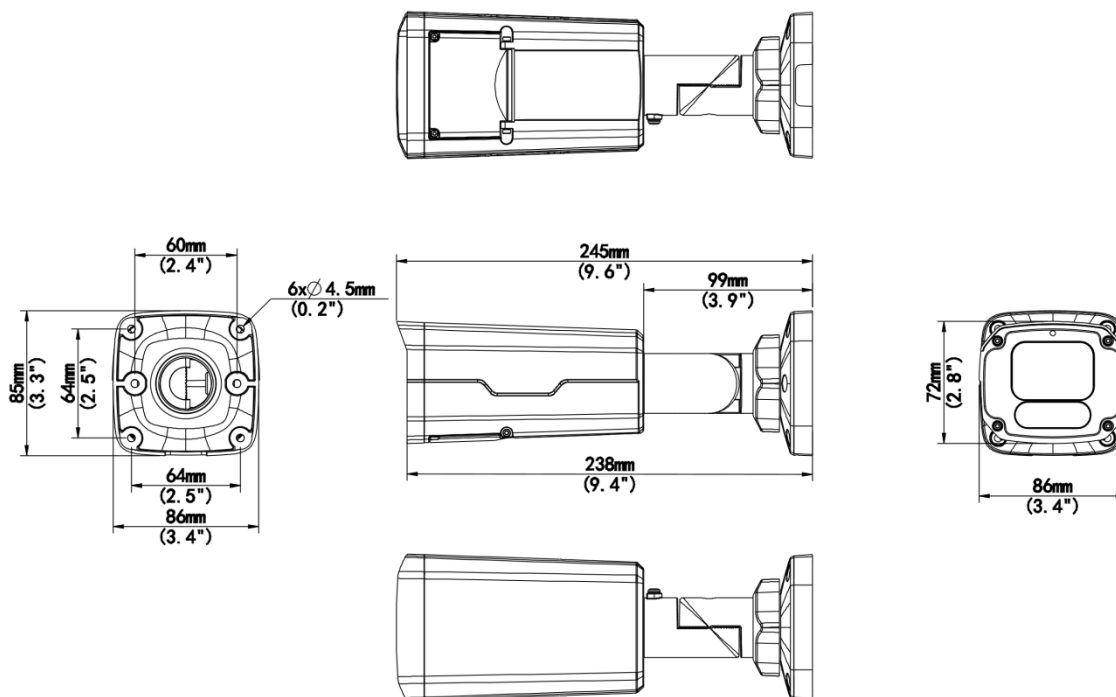

| | |
|----------------------------|---|
| Video Bit Rate | 128 Kbps to 16 Mbps |
| ROI | Support |
| Video Stream | Dual streams |
| OSD | Up to 4 OSDs |
| Intelligent | |
| Smart Intrusion Prevention | Cross line detection, intrusion detection (support false alarm filtering and the classification of human and vehicle) |
| Events | |
| Basic Detection | Motion detection, Ultra motion detection (based on human body and vehicle detection), Tampering alarm, Audio detection |
| General Function | Watermark, IP address filtering, Access policy, ARP protection, RTSP authentication, User authentication, HTTP authentication, Alarm input, Alarm output |
| Audio | |
| Audio Compression | G.711U, G.711A |
| Audio Bitrate | 128 Kbps |
| Two-way Audio | Support |
| Suppression | Support |
| Sampling Rate | 16KHZ |
| Storage | |
| Edge Storage | MicroSD, up to 512 GB |
| Network Storage | ANR, NAS (NFS) |
| Network | |
| Protocols | SSH, IGMP, RTP, RTCP, SMTP, IPv4, IPv6, ICMP, ARP, TCP, UDP, DHCP, PPPoE, RTSP, RTMP, DNS, DDNS, NTP, FTP, UPnP, HTTP, HTTPS, 802.1x, SNMP, QoS, SSL/TLS |
| Compatible Integration | ONVIF (Profile S, Profile G, Profile T, Profile M), SDK, API |
| User/Host | Up to 32 users. 3 user levels: administrator, common user and operator |
| Security | TLS 1.3, Password Protection, Strong Password, HTTPS Encryption, Export Operation Logs, Basic and Digest Authentication for RTSP, Digest Authentication for HTTP, TLS 1.2, WSSE and Digest Authentication for ONVIF |
| Client | EZStation, UNV-Link, UNV-Link Pro |
| Web Browser | Plug-in required live view: IE 10+, Chrome 45+, Firefox 52+, Edge 79+, Plug-in free live view: Chrome 57+, Firefox 58+, Edge 16+ |
| Interface | |
| Audio I/O | 1 Input: impedance 1 k Ω , amplitude 2.5 V [p-p], 1 Output: impedance 600 Ω , amplitude 2.5 V [p-p] |
| Alarm I/O | 1/1 |
| Built-in Mic | Support |
| Network | 1 \times RJ45 10 M/100 M Base-TX Ethernet |
| Certification | |
| EMC | CE-EMC (EN 55032: 2015+A1:2020, EN 61000-3-3: 2013+A1: 2019, EN IEC 61000-3-2: 2019+A1: 2021, EN 55035: 2017+A11:2020) FCC (FCC CFR 47 part15 B, ANSI C63.4-2014) |
| Safety | CE LVD (EN 62368-1:2014+A11:2017) UL (UL 62368-1, 2nd Ed., Issue Date: 2014-12-01) |

| | |
|---------------------|---|
| Environment | CE-RoHS (2011/65/EU;(EU)2015/863); WEEE (2012/19/EU); Reach (Regulation (EC) No 1907/2006) |
| Protection | IP67 (IEC 60529:1989+AMD1:1999+AMD2:2013) IK10 (IEC 62262:2002) |
| General | |
| Power | DC 12 V (±25%), PoE (IEEE 802.3af) |
| Power Consumption | Max. 8 W |
| Power Interface | Ø5.5 mm coaxial power plug |
| Dimensions | 245 mm × 87 mm × 86 mm (9.6" × 3.4" × 3.4") (L × W × H) |
| Weight | 0.82 kg (1.81 lb.) |
| Working Environment | -30°C ~ 60°C (-22°F ~ 140°F), Humidity: 5%~95% RH (non-condensing) |
| Storage Environment | -40°C ~ 70°C (-40°F ~ 158°F), Humidity: 5%~95% RH (non-condensing) |
| Web Client Language | 22 Languages: Traditional Chinese, English, Simplified Chinese, Polish, German, Russian, French, Korean, Dutch, Czech, Portuguese (Europe), Portuguese (Brazil), Japanese, Thai, Turkish, Spanish (Latin America), Spanish (Europe), Hungarian, Italian, Vietnamese, Arabic, Slovak |

Dimensions



Accessories

| | | |
|---|---|--|
| <p>TR-JB07-D-IN Bullet Junction Box(Support wiring from behind)</p> | <p>TR-JB07-D-IN-V2 Bullet Junction Box(Support wiring from behind)</p> | <p>TR-JB06-A-IN Middle Bullet Junction Box(Elegant White)</p> |
|  |  |  |
| <p>TR-UP06-B-IN Bullet Pole Mounting Bracket</p> | <p>TR-A01-IN NPT 3/4" Waterproof Cable Gland</p> | <p>TR-UP06-C-IN-V2 Pole Mounting Bracket for Bullet Junction Box Only</p> |
|  |  |  |

Unlimited New View

Zhejiang Uniview Technologies Co., Ltd.

 <http://www.uniview.com>

 overseasbusiness@uniview.com; globalsupport@uniview.com

 No. 369, Xietong Road, Xixing Sub-district, Binjiang District, Hangzhou City, 310051, Zhejiang Province, China



©2023-2025 Zhejiang Uniview Technologies Co., Ltd. All rights reserved.

*Product specifications and availability are subject to change without notice.

Despite our best efforts, technical or typographical errors may exist in this document. Uniview cannot be held responsible for any such errors and reserves the right to change the contents of this document without prior notice.