

4MP LightHunter WDR Network Dome Camera IPC3234EA

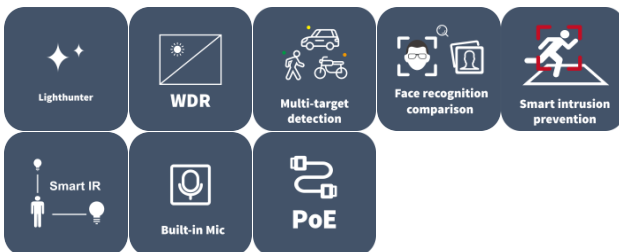

Features

- High quality image with 4 MP, 1/1.8" CMOS sensor
- 2688 × 1520@60 fps in the main stream, offering smoother live video and more details
- Ultra 265, H.265, H.264, MJPEG
- Wise-ISP technology, comprehensive improvement in image quality
- Metadata analysis, supports human body, motor vehicle and non-motor vehicle image capture and attribute collection, realizes data visualization management, allows users to get target information for further data analysis
- supports front-end comparison, supports blocklist and allowlist comparison, increases the concurrent detection number up to 120
- Smart intrusion prevention, supports false alarm filtering, including cross line, intrusion, enter area, leave area detection
- People counting, supports people flow counting and crowd density monitoring, suitable for different statistical scenarios
- LightHunter technology ensures ultra high image quality in low illumination environment
- Up to 140 dB optical WDR (wide dynamic range)
- DC 12 V, PoE (IEEE 802.3af) power supply
- Wide voltage range of $\pm 25\%$ in DC

Specifications

Model	IPC3234EA-AHDZK-I1	IPC3234EA-AHDX4K-I1
Camera		
Max Resolution	4 MP	
Sensor	1/1.8" CMOS	
Min. Illumination	Color: 0.0003 Lux (F1.2, AGC ON), BW: 0.0001 Lux (F1.2, AGC ON), 0 Lux with IR	Color: 0.0005 Lux (F1.6, AGC ON), BW: 0.0003 Lux (F1.6, AGC ON), 0 Lux with IR
Day/Night	IR-cut filter with auto switch (ICR)	
Shutter	Auto/Manual, 1 to 1/100000 s	
WDR	140 dB	
S/N	>56 dB	
Lens		
Focal Length	2.8 to 12 mm	8 to 32 mm
Optical Zoom	4X	
Iris	F1.2	F1.6
Field of View (H)	106.6° to 51.3°	42.6° to 15.2°
Field of View (V)	56.9° to 28.6°	23.5° to 8.9°
Field of View (D)	131.1° to 63.1°	52.4° to 17.9°
Iris Type	P-iris	
DORI		
DORI Distance (Detect)	68.0 m to 166.2 m (223.0 ft. to 545.2 ft.)	124.1 m to 496.6 m (407.3 ft. to 1629.1 ft.)
DORI Distance (Observe)	27.2 m to 66.5 m (89.2 ft. to 218.1 ft.)	49.7 m to 198.6 m (163.1 ft. to 651.6 ft.)
DORI Distance (Recognize)	13.6 m to 33.2 m (44.6 ft. to 109.0 ft.)	24.8 m to 99.3 m (81.4 ft. to 325.8 ft.)
DORI Distance (Identify)	6.8 m to 16.6 m (22.3 ft. to 54.5 ft.)	12.4 m to 49.7 m (40.7 ft. to 162.9 ft.)
Video		
Video Compression	Ultra 265, H.265, H.264, MJPEG	
Video Bit Rate	128 Kbps to 16 Mbps	
ROI	Support	
Video Stream	Triple streams	
Privacy Mask	Up to 8 areas (8 blacks / 8 mosaics)	
OSD	Up to 10 OSDs	
Frame Rate-Main Stream	4 MP (2688 × 1520), max. 60 fps	
Frame Rate-Sub Stream	1080P (1920 × 1080), max. 60 fps	
Frame Rate-Third Stream	D1 (720 × 576), max. 60 fps	
Intelligent		
Recognition	Face recognition: Max support 16 face libraries; Max supports 100000 faces in face library	
Metadata Analyse	Support human body, human face, motor vehicle and non-motor vehicle image capture and attribute collection	
Exception Detection	Object removed Object Left Behind Scene change Defocus detection	Object removed Object Left Behind
Metadata of Multi-target Detection	Gender (face), Age range (face), Glasses (face), Gender (pedestrian), Mask (pedestrian), Upper garment color (pedestrian), Lower garment color (pedestrian), Upper garment style	

	(pedestrian), Lower garment style (pedestrian), Bag style (pedestrian), Uppper garment color (non-montor vehicle), Uppper garment style (non-montor vehicle), Vehicle type (non-montor vehicle), Vehicle type (motor vehicle), Vehicle color (motor vehicle), Vehicle brand (motor vehicle), Plate number (motor vehicle)	
Smart Intrusion Prevention	Cross line detection, intrusion detection, enter area detection, leave area detection (support false alarm filtering and the classification of human, non-motor vehicle and vehicle)	
People Counting	Support people flow counting and crowd density detection	
Multi-target Detection	Support human body, human face, motor vehicle and non-motor vehicle image capture and attribute collection	
Supports Multiple Countries	North America: United States, Canada;South America: Mexico, Brazil; EU: France, Spain, Portugal, Germany, UK, Ireland, Bulgaria, Latvia, Romania, Slovenia, Poland, Hungary, Serbia, Czech Republic, Slovakia, Bosnia and Herzegovina, Greece, Croatia, Ukraine, Lithuania, Georgia; Asia Pacific: South Korea, Indonesia, Malaysia, Singapore, Viet Nam, Bangladesh, India, Nepal, Philippines, Thailand, Cambodia;Middle East: Iraq, Saudi Arabia, United Arab Emirates, Egypt, Qatar, Tunisia, Yemen; Kuwait, Oman, Bahrain; Middle Asia: Kazakhstan, Kyrgyzstan, Tajikistan, Uzbekistan, Turkmenistan	
Image		
White Balance	Auto&Outdoor&Fine Tune&Sodium Lamp&Locked&Auto2	
Digital Noise Reduction	2D/3D DNR	
Flip	Normal&Flip Vertical&Flip Horizontal&180°&90°Clockwise&90°Anti-clockwise	
HLC	Support	
BLC	Support	
Smart IR	Support	
Defog	Digital defog	
EIS	Support	
Events		
Basic Detection	Motion detection Tampering alarm Audio detection Object removed Object Left Behind Scene change Defocus detection	Motion detection Tampering alarm Audio detection Object removed Object Left Behind
General Function	Watermark&IP Address Filtering&Access Policy&ARP Protection&RTSP Authentication&User Authentication&HTTP authentication&Alarm input&Alarm output	
Audio		
Audio Compression	G.711U&G.711A	
Audio Bitrate	128 Kbps	
Two-way Audio	Support	
Suppression	Support	
Sampling Rate	16KHZ	
Storage		
Edge Storage	MicroSD, up to 512 GB	
Network Storage	ANR&NAS(NFS)	
Network		
Protocols	IGMP, RTP, SMTP, IPv4, IPv6, ICMP, ARP, TCP, UDP, DHCP, PPPoE, RTSP, RTCP, RTMP, DNS, DDNS, NTP, FTP, UPnP, HTTP, HTTPS, 802.1x, SNMP, QoS, SSL/TLS, SSH, TLS1.3	

Compatible Integration	API, SDK, ONVIF (Profile S, Profile G, Profile T, Profile M)	
User/Host	Up to 32 users. 3 user levels: administrator, common user and operator	
Security	Password protection&Strong password&HTTPS encryption&Export operation logs&Basic and digest authentication for RTSP&Digest authentication for HTTP&TLS 1.2&WSSE and digest authentication for ONVIF	
Client	EZStation, UNV-Link, UNV-Link Pro	
Web Browser	Plug-in required live view: IE 10 and above, Chrome 45 and above, Firefox 52 and above, Edge 79 and above&Plug-in free live view: Chrome 57.0 and above, Firefox 58.0 and above, Edge 16 and above	
Illuminator		
Illumination Distance (IR)	40 m (131.2 ft.)	
IR On/Off Control	Auto/Manual	
Wavelength	850 nm	
Interface		
Audio I/O	2 Input: impedance 1 k Ω , amplitude 2.5 V [p-p], 1 Output: impedance 600 Ω , amplitude 2.5 V [p-p]	
Alarm I/O	3/2	
Serial Port	1 \times RS485	
Built-in Mic	Support, built-in mic*2	
Built-in Speaker	Support	
Network	1 \times RJ45 10 M/100 M/1000 M Base-TX Ethernet	
Certification		
EMC	CE-EMC (EN 55032: 2015+A1:2020,EN 61000-3-3: 2013+A1: 2019,EN IEC 61000-3-2: 2019+A1: 2021,EN 55035: 2017+A11:2020) FCC (FCC CFR 47 part15 B, ANSI C63.4-2014)	
Safety	CE LVD (EN 62368-1:2014+A11:2017) UL (UL 62368-1, 2nd Ed., Issue Date: 2014-12-01)	
Environment	CE-RoHS (2011/65/EU;(EU)2015/863); WEEE (2012/19/EU); Reach (Regulation (EC) No 1907/2006)	
Protection	IP67 (IEC 60529:1989+AMD1:1999+AMD2:2013) IK10 (IEC 62262:2002)	
General		
Power	DC 12 V (\pm 25%), PoE+ (IEEE 802.3af)	
Power Consumption	17 W	18 W
Power Interface	\varnothing 5.5 mm coaxial power plug	
Built-in DC12V Output	Support	
Dimensions	\varnothing 148 mm \times 111.4 mm (\varnothing 5.8" \times 4.4") ($\varnothing \times$ H)	
Weight	1.01 kg (2.23 lb.)	1.06 kg (2.34 lb.)
Working Environment	-30°C ~ 60°C (-22°F ~ 140°F), Humidity: \leq 95% RH (non-condensing)	
Surge Protection	6 KV	
Reset Button	Support	
RTC	Support	
Material	Body: Metal	
Heater	Support	
Live View		



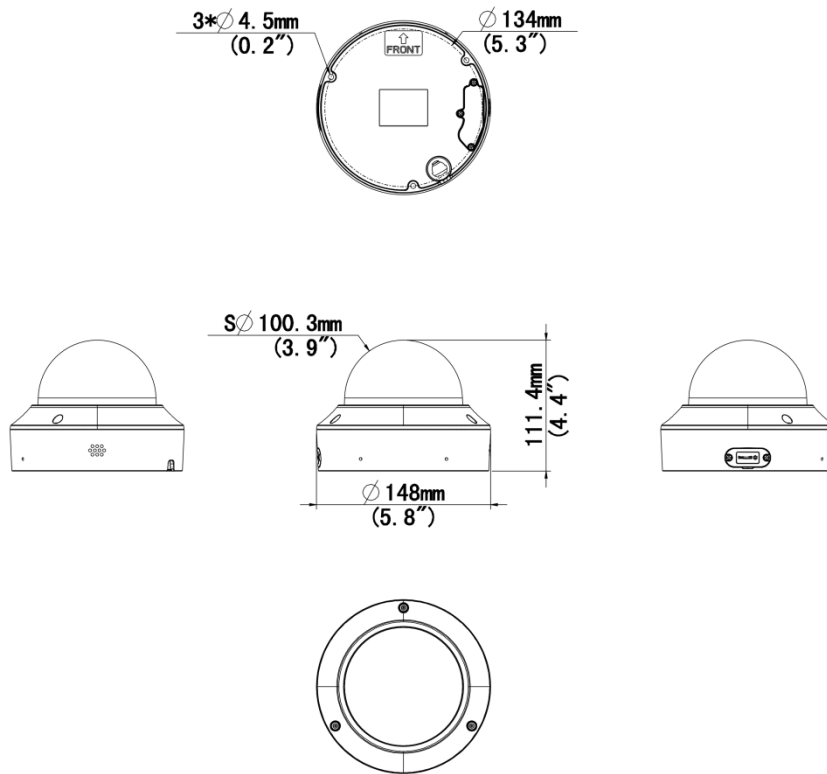

Maximum Bitstream	35
Other	
Corridor Mode	Support
Configurable	
P/N	Support

Dimensions



Accessories

TR-JB04-C-IN	TR-JB07/WM04-B-IN	TR-WM04-IN
Junction Box for 323 Series Fix-dome(Support wiring from behind)	4 Inch Back Hole Hemisphere Wall Mounting Assembling Bracket	4 Inch Hemisphere Wall Mounting Bracket

<p>TR-FM152-A-IN In-ceiling Bracket for 323 Series Fix-dome</p>	<p>TR-SM04-IN Switch Box Adapter for 323 Series Fix-dome</p>	<p>TR-A01-IN NPT 3/4" Waterproof Cable Gland</p>
		
<p>TR-UP06-IN Universal Pole Mounting Bracket</p>	<p>TR-UC08-C Bullet&Dome Corner Mounting Bracket</p>	
		

Unlimited New View

Zhejiang Uniview Technologies Co., Ltd.



<http://www.uniview.com>



overseasbusiness@uniview.com; globalsupport@uniview.com



No. 369, Xietong Road, Xixing Sub-district, Binjiang District, Hangzhou City, 310051, Zhejiang Province, China



©2023-2025 Zhejiang Uniview Technologies Co., Ltd. All rights reserved.

*Product specifications and availability are subject to change without notice.

Despite our best efforts, technical or typographical errors may exist in this document. Uniview cannot be held responsible for any such errors and reserves the right to change the contents of this document without prior notice.